



TI-Jupiter User's Manual

*Make your life healthy
and beautiful every day!*



Please read SAFETY INSTRUCTIONS carefully before using the chair.

Titan Chair

Introduction to the Titan Jupiter

1. The intelligent 3D technology will deliver a consistent soothing massage from your neck to down to your hamstrings. Adopting traditional Oriental massage methods, you will come to experience a soothing kneading, pressing, tapping and shiatsu style massage that will invigorate the senses and relax the body.
2. With acupuncture point tracking innovation. It will deliver a massage that will massage the key areas while adjusting to different body type.
3. To enhance the massage experience the backrest is fitted with a warm soothing heating pad
4. The Jupiter massage chair is equipped with a highly advanced L track system that reaches neck to the hamstrings.
5. One simple touch of the remote recline back into a comfortable zero gravity position that promotes an even distribution of weight throughout the back.
6. The forward sliding space saving technology is one of the great features that greatly eliminate the awkward space required to recline. The backrest and seat frame glides forward as you recline the chair.
7. With advanced wireless Bluetooth technology, mobile or tablet device can be synced with the massage chair, to answer calls or listen to your favorite tunes.
8. The foot massager has a rounded points that scrape the bottoms of the feet in combination with air bags that apply a squeezing/kneading action.
9. In the calf region the airbags will deliver a pulsating action that that will squeeze the and release, refreshing the legs.
10. For the arms the same type of airbag massage is delivered. Simply slide your arms into the slots soon as you select the massage of your preference.
11. Multiple airbags are thoughtfully placed throughout the chair to provide a fully body massage experience.
12. The legrest and foot parts can be adjusted to any angle that you needed, It can extended and retracted within the range of 15cm, to accommodate varies heights.
13. The high resolution LCD screen allows the user to see what the chair is performing and where the massage roller heads are located.

- ✧ 1.Thank you for selecting the highly advanced Jupiter massage chair by Titan..
- 2.Please read this manual carefully before using the massage chair.
- 3.Please keep this manual in a safe place for further reference.
- 4.Please pay attention to SAFETY INSTRUCTIONS.

✧ Note: We reserve the right for design modification. It is subject to change without notice. The pictures in this manual are only for reference. Please refer to the actual product.

Content

Preparation

Safety instructions -----

External structure parts -----

Internal structure parts -----

Mechanical components diagram -----

Mechanical components list -----

Installation

Installation -----

Massage Operation

The adjustment before massage -----

Manual control -----

Operation instruction &function illustration -----

After massage -----

Maintenance

Clean and maintenance -----



Malfunction guide ----- 23

Technical data ----- 24





Please keep this manual in a safe place for future reference.

- ✦ Please read this manual carefully to make sure the installation and operation of the massage chair is correct.
- ✦ Safety Instructions are provided in in this manual with Warning and Caution to ensure the safety of the user.

Warning and Caution are highly important so please be aware of all safety warnings.

 Warning	This sign indicates warning of possible sever injury if not handled correctly.
 Caution	This sign indicates caution. if not handled properly the chair may be damaged.

Symbol meaning



	This sign indicates forbidden action.		This sign indicates self disassembly is forbidden.
	This sign indicates you must follow instruction to operate.		This sign indicates the correct operation of cable.

- ✦ The following should be kept for any further references.

Preparation



Warning

	<ul style="list-style-type: none"> ● person with Osteoporosis are not permitted to use this product. ● People with heart disease including implanted pacemaker or other medical electronic device are not permitted. ● For pregnant women or people with any medical condition, please consult doctor before using. ● Patients with a high fever are forbidden to use this machine. ● Perceptual disabilities patients are forbidden to use this device. ● People who are elderly should consult with their doctors prior. ● Children must consult with their doctors prior to using. ● Do not sleep in the chair. This may lead to serious injury. ● Don't use the chair when your body is wet to prevent injury. 	People who are not suitable to use the chair
	<ul style="list-style-type: none"> ● Make sure there are no kids or pets or other objects around (under, behind or in front of)when the chair is in operation. ● During operation, if you feel any abnormal discomfort, please stop the operation and immediately consult your physician. ● Please do not use the chair to massage above your neck. ● This chair is intended to be used in the sit down position. ● Do not use this chair while intoxicated. ● If you have any neck or back issued you must get approval by your doctor. ● This chair produces a minor electrical field, therefore anyone with metal plating or medical devices should consult your doctor. 	Accident/injury
	<ul style="list-style-type: none"> ● Insert the plug of the chair into correct power outlet. Make sure the plug is completely inserted into the socket to prevent short circuit or fire. ● Unplug the power when not in use, stop all massage functions and turn off before unplugging. 	Fire and electric shock
	<ul style="list-style-type: none"> ● It is prohibited to use the massage chair with any blankets or coverings which may lead to damage or injury. ● Massage cushions of the chair are not permitted to be folded or removed to prevent injury. ● The machine is forbidden for use if no one is sitting in the chair. 	Accident
	<ul style="list-style-type: none"> ● Be sure the power cord or any wires are in good condition. ● Don't use other electric power except rated voltage to avoid fire, electric shock or any breakdown. ● Any broken, re-process, knotted, twisted power cord or pressed under chair is not allowed for use. 	Fire and electric shock
	<ul style="list-style-type: none"> ● If the chair has been exposed or made contact with any fluids STOP using and unplug the chair from the outlet until it has been inspected and repaired by a certified technician. ● If power cord or plug is damaged, please don't replace it yourself, please contact us or appointed dealer for replacement. ● To avoid electric shock or bodily injury please don't open or disassemble any part of the chair. The chair should not be handled by the customer unless approved by the manufacturer. ● Check the upholstery or cloth material on the back and other areas for damage or extreme wear. If broken, even though it is small, please stop using the chair, unplug the power and have it repaired to prevent from major damage. 	Disassembly and maintenance

Preparation

**Caution**

!	● The chair must be placed on a flat even surface.	To avoid sudden falling.
	● The backrest of the chair when upright must be placed a minimum of 10 cm from the wall.	To make sure the back lying.
	● The maximum suggested operating time is 20mins. A maximum of 5 minutes for the upper, mid and lower back is advised to avoid injury.	Too long time massage is bad for your body.
	● Before sitting on the chair to avoid injury please inspect everything to confirm that the massage heads are in the correct position.	To avoid accidental injury.
	● Remote control should be put in the pocket or in the bracket. Do not put the remote control anywhere besides the suggested locations to avoid damage.	
	● Please make sure that the power switch is at the "OFF" position before inserting the plug into the socket.	
	● Turn off all remote before removing plug from outlet.	To avoid the accident when turn on the power.
	● Make sure the plug is completely insert into outlet.	To reduce short circuits and any fire hazard.
● Checking for any damage on wire and make sure there is no fluids are near or on wire. ● Do not tamper or remove the ground wire The plug must be inserted into socket with the ground prong in tack and in good condion.	To avoid electric shock in any leakage or breakdown.	
⊘	● Don't press down on the massage heads with hands or step on the massage heads with feet. this will damage the chair.	To avoid accidents or injury
	● Don't put hands between the working massage heads.	
	● Don't put hands or feet in the gap of mechanical parts.	
	● Don't drop or embed anything into the cracks of massage chair.	
	● Don't stand or sit or put anything on the backrest, armrest or leg-rest.	
	● Don't stand on the chair during operation.	
	● Don't move the chair during operation.	
	● Don't pull out the plug or turn off the power during operation.	
	● Don't put your hands or head between leg-rest or beneath it.	
	● Don't use the massage chair while wearing hair accessories.	
● Remove everything in your pockets or hard objects that may cause injury.		
● Don't apply additional force on the backrest when sitting in the chair.		
● When using the this product, you must be properly clothed to prevent injury or irritation to the skin.		
⚠	● Keep the chair away from heat, fluids, sharp things and corrosive, inflammable, explosive products.	To avoid fade, discolor on upholstery or hardened, deteriorated on PU.
	● To use electric blanket or other heating products on the chair is forbidden.	
	● Don't place near any corrosive or or flammable products	
	● Don't put the chair in a small space places or use in areas with poor air circulation.	
	● Keep the chair away from stove or other heating products.	
	● Do not expose the chair to sunlight or areas with temperatures above 85 degrees Fehreinhiel.	
● Don't use the chair outdoors or sunrooms.		

**Caution**

	● Do not place this chair in areas that have above normal humidity levels. Keep away from fluids and must be dry at all times. The power cord must be the original one provide. If not contact the manufacturer. Do not use until approved by manufacturer or certified electrician.	To avoid leakage or electric shock.
	● It is imparitive that all electrial wires are in good condition and that there are no visiable cracks or exposures of the wires. Be sure the power cords are all firmly inserted into the chair and the wall outlet. When using the chair, no part of your body should be wet, especially the hands.	To avoid electric shock.
	● Unplug the powercord form the outlet before cleaning chair.	To avoid electric shock or fire harzard.
	● When the chair is not being used unplug from the outlet.	
	● If the chair has any burning smell immediately unplug the power.	
	● When removing the plug from the outlet, firmly hold form the head of the plug. Do not pull from the wire portion.	
	● Please turn off the power switch and unplug the power after massage.	To avoid accidents
● Unplug the power immediately when electricity goes out	To avoid damage or accidents when power on again.	

Grounding instruction

- ✦ ※The chair is equipped with a cord having an grounding conductor. The plug must be plugged into an appropriate socket that is properly installed and matched with the plug.

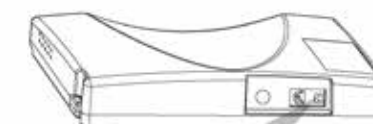
**Replace fuse**

- ✦ ※When the fuse is burned out, please turn off the switch and unplug the power. If the chair is not powering up, please check the fuse by removing plug cover shown on the right.. Using a same size fuse with the same rating to replace the old one, then cover the lid. Or you can contact the manufacturer for a certified electrician.



The ground wire is not allowed to be in these places

Keep the power cord away from the following:

- Telephone lines, gas pipes
- During heavy thunder storms that may lead to power outages, unplug the chair
- The power cord must at all times stay dry.

External structure

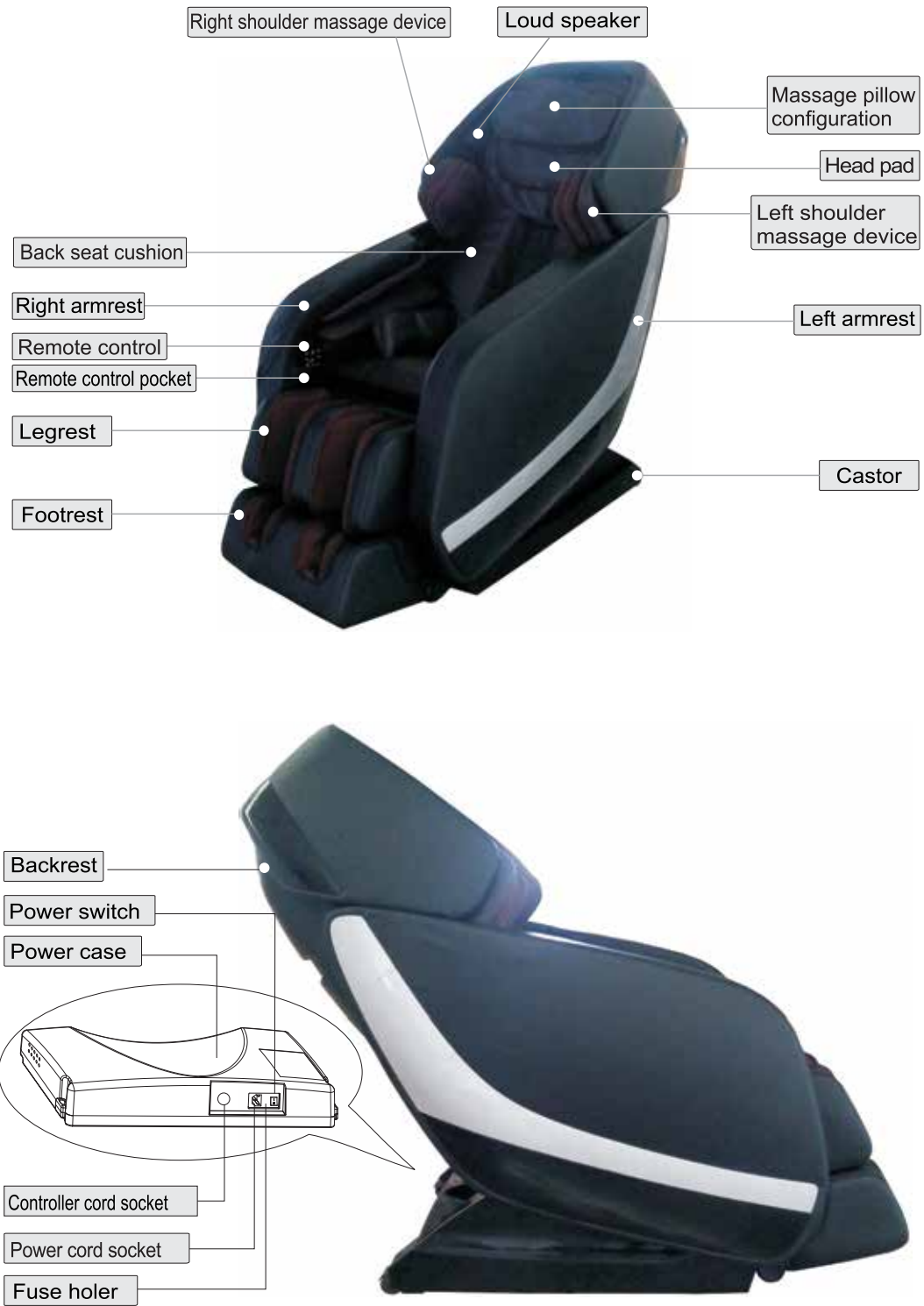

Preparation

Internal structure

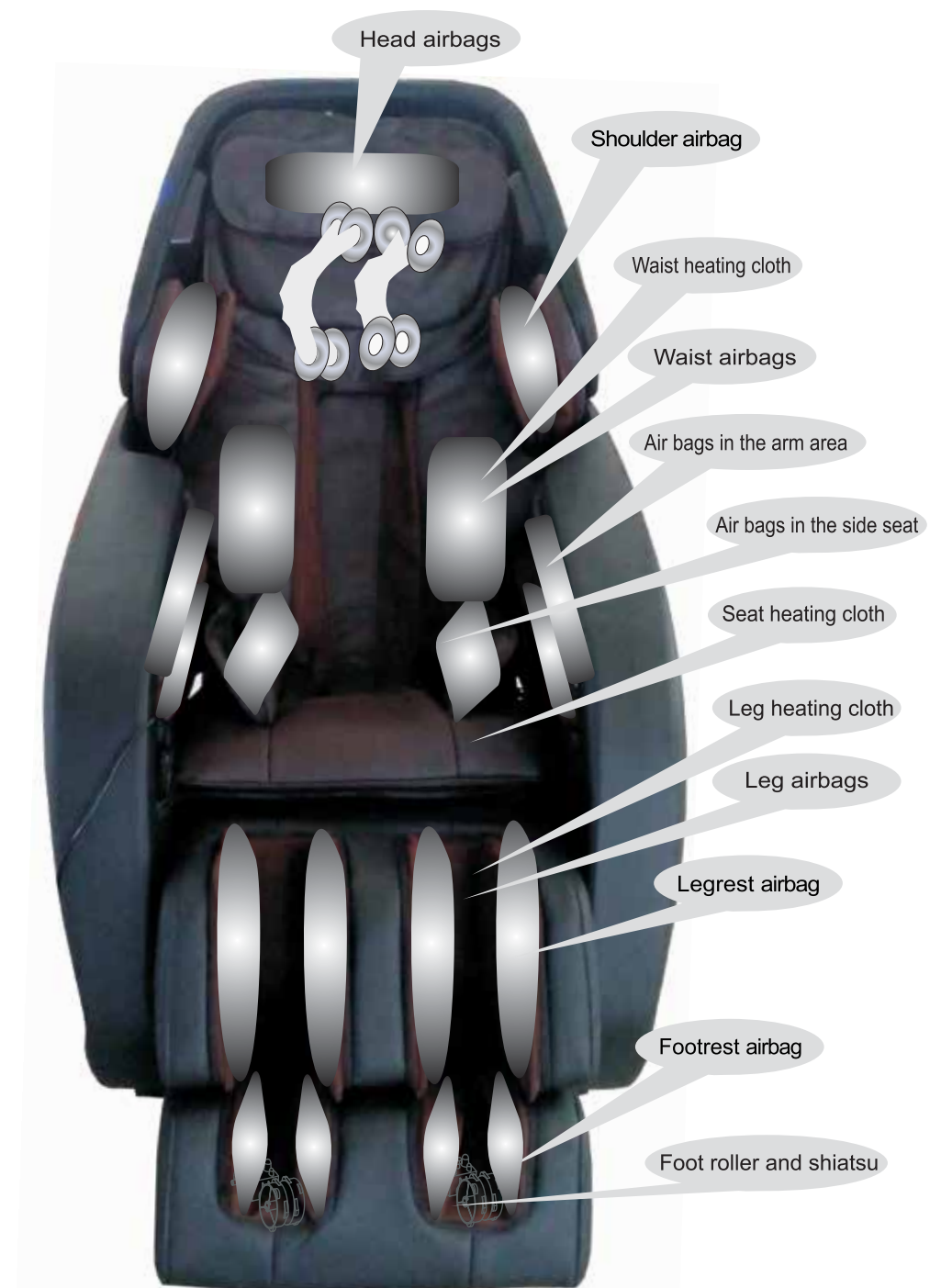

Preparation

Explosion Diagram

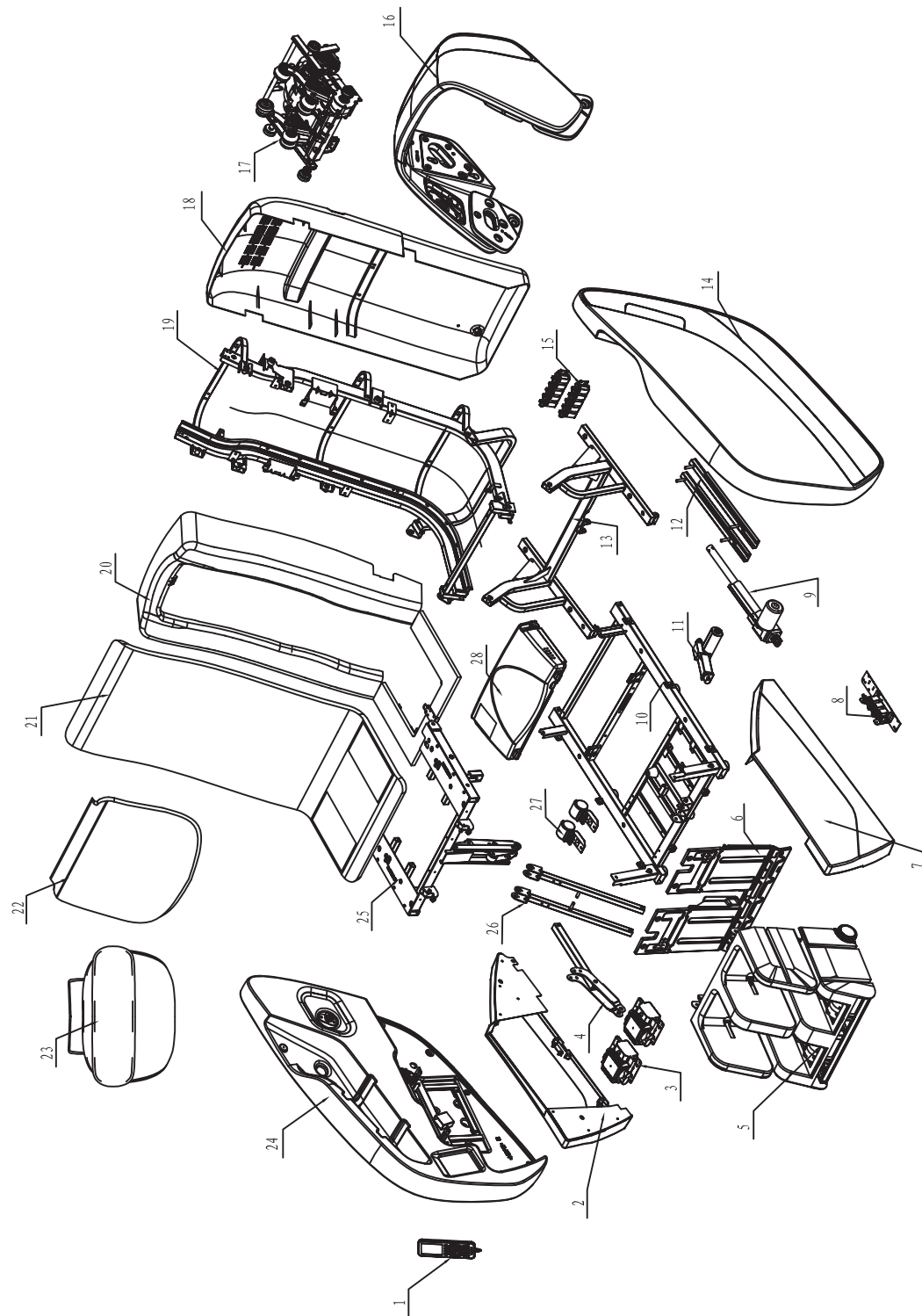

Preparation

Mechanical components list

NO.	Name	Q' ty	NO.	Name	Q' ty
1	Remote control	1	22	Shoulder pads	1
2	Right side fender	1	23	Pillow	1
3	Air pump assembly	1	24	Right armrest assembly	1
4	connecting rod	1	25	Seat frame surface assembly	1
5	Legrest & footrest	1	26	Seat support bar	1
6	Front fender	1	27	Castor	2
7	Left side fender	1	28	Power case assembly	2
8	Electric magnetic valve	1			1
9	Backrest electric actuator	1			
10	Bottom seat frame assembly	1			
11	Footrest electric actuator	1			
12	Sliding rail	2			
13	Top seat frame assembly	1			
14	Left armrest assembly	1			
15	Electric magnetic valve	2			
16	Shoulder massage device	1			
17	Massage machine	1			
18	Back cover assembly	1			
19	Back frame assembly	1			
20	Backrest plastic front cover and seat plate assembly	1			
21	Back and seat cushion	1			

Preparation

Installation (1)

Step 1. How to move the chair

- ① Cut the straps and unpack the box to access the base of the chair. Remove all pads and cushions from the base and lift the chair from the points indicated in image below. With 2 or more people, lift carefully and move the chair to the desired location.
- ② Be sure to keep all the cushions, remote and power cord together so that nothing is lost.

(as the picture shows)



Head pad Back seat cushion



Remote control Electric power cable

When moving the chair, one hand must grab the metal frame along the seat base. The other hand will grab from behind the backrest. Refer to the image below.



Massage chair main body



Left armrest Right armrest

- ③ Take out the left and right armrest from the armrest carton box. Remove the armrest slowly and carefully. We recommend that you lay the armrest face up on a blanket or carpeted floor to avoid scratches and tears. When holding the armrest, handle by grabbing on the indicated areas (image on the right).

- ④ Take out the legrest from the legrest box. remove from the box by grabbing the indicated locations.



Legrest device

Installation (2)

Step 2. Massage chair position return

- 1. Once the chair base and backrest are removed from the box, insert the power cord into the chair and then into the outlet 2. Turn on the power switch on the back of the chair and the backrest will raise up as the seat base levels flat. 3. Once the chair is in the upright position turn off the chair and proceed to next step of the install. (Refer to step 7, after the assembly)



Massage chair position return state

Step 3. How to assemble the legrest

- Install the legrest to the main chair body. 1. Unscrew the bolt from the hanger of legrest . 2. Please insert three air tubes of the legs into the air taps of the main body. Connect the air tubes according to the color code. 3. Above the air connections, insert the power connector into the socket firmly. 4. Lift up the legrest and align the axis into the hanger of main body, then put down the axis cover. 5. Screw on the bolt tightly.



Installation (3)

Step 4. How to assemble the left and right armrest

① Unscrew the bolt designated as M6 on the seat frame with cross screwdriver. ② Insert the hole on the on the armrest into the fixed bolt. ③ Insert the square tube into the side piece of the seat frame. ④ Be sure the side panel holes line up in the front and back. Thread the M6 bolt and proceed to tighten. ⑤ Open the zipper around the shoulder air bags, pull out the air bags, aligned the holes to the shoulders between airbags and armrest, then put the screws inside the screw hole until fastened. Zip up at last. ⑥ put the armrest tubes connect into the seat tubes.

⚠ Be sure the air hose is not bent, cracked or twisted when connecting. This will prevent any blockage.

✦ Disassemble the armrest: Zip up and remove the screws before disassembling the shoulder airbag. Disconnect the air tubes between the seat and armrest, unscrew the four screws on the seat. Then lift up the front of armrest, let the square tube of armrest move out from the plate of seat frame. Then press the button on the fixed hole which is near the back on the inside part of the armrest. Then pull the end of armrest at same time, move the fixed hole away from the fixed bolt which on the side of backrest.



Installation (4)

Step 5. Connect the zipper or velcro

Put the back seat cushion, head pad onto the backrest and connect the two parts with zipper and velcro.

★ Warm tips

When selecting a pre-programmed massage, be sure to be still and keep your butt pressed to the backrest as the chair will initiate a computer body scan.

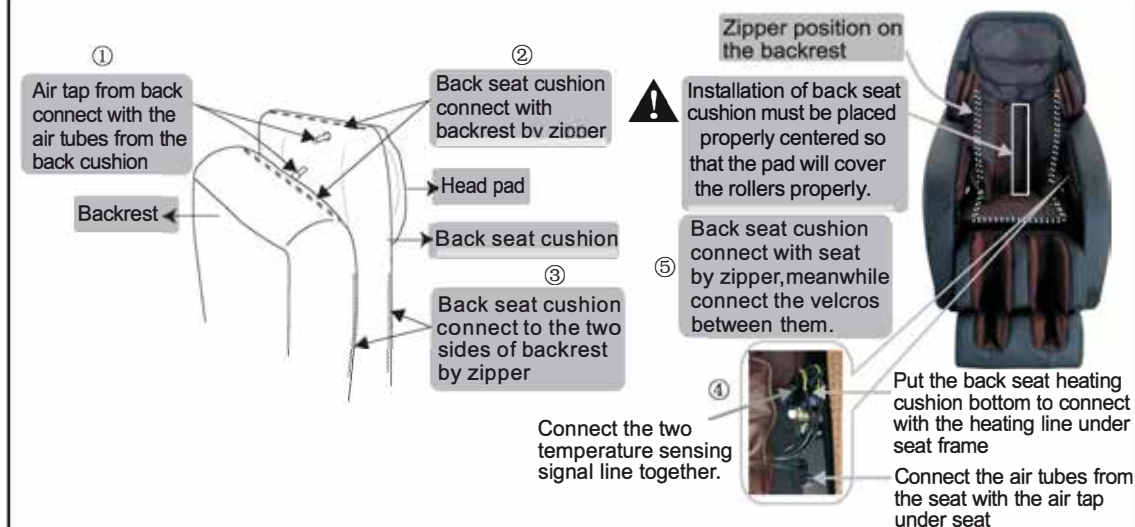

Step 6. After the Assembly

After the assembly, please operate the chair in this order:

- 1 Plug the cable line in the hole a on the power box as shown in the right picture.
 - Hole A connect with one end of cable line.
 - Hole b insert plug of the remote control.
- 2 Insert the plug of cable line into the socket.
- 3 Switch on. (Switch on/off "O/I", press I down to turn it on.)
- 4 Enjoy the massage by using the remote control.

⚠ Make sure the switch is off before you insert the plug of cable line into the socket.

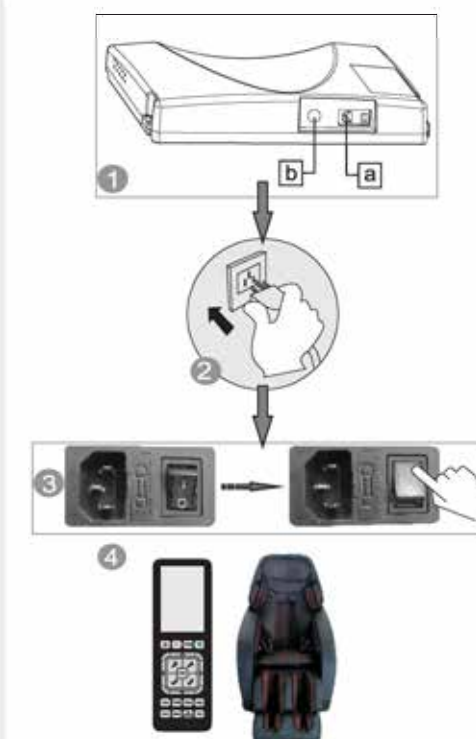

Environment



Caution



Don't use the chair in wet places like near swimming pool, bath room to avoid leakage or electric shock.



Don't use under sunlight or near stove or other heating place to avoid upholstery deteriorated.



Please use chair in flat place to avoid chair falling or noise or other unexpected trouble.

● Check places in front

Check the areas when back and leg extending, make sure no people, pets or other things around.



● Check power cable, plug

- (1) Clean the dust on plug on time. (using dry cloth).
- (2) No damage, re-do, bend, stretch, tie or press with heavy thing (especially can't be pressed by the chair) on power cable.



Check environment

● Space size for using the chair

- At least 10cm from wall.



- At least 30cm in front of the leg:

● Check surroundings

When the backrest or legrest reclines or extends, please pay attention to:

- (1) Check any person or things in every direction.
- (2) Check the space size.



How to move massage chair



Caution

- ✦ Don't move chair when it's working in case of accidents or damage

How to move

- ✦ Bind the cables and put them in the seat to avoid damage when moving.
- ✦ If you plump the chair, it may damage the inner parts of the chair.
- ✦ Don't use the castor if the floor is wooden or other easy damaged material. It will need 2 or more persons to lift the chair.
- ✦ Make sure the power is off and the plug doesn't touch the floor (It's better to let the chair in standing status to avoid the back crashing the floor)



Normally

- 1 Lift up the legrest to make the gravity fall on the castor. Then push chair to destination and set it down.

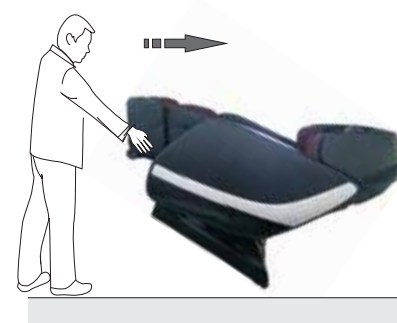

- ⚠ Please hold the footrest to move the chair as shown in the picture in case any scratches on the leatherette

Adjustment before massage

● Before adjustment

- ✦ Please make sure the massage head in the seat part before sitting on the chair.
- ✦ To avoid injury caused by wrong position of the massage head.

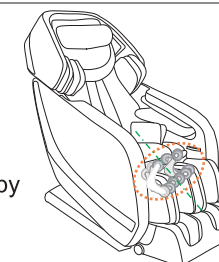

✦ Acupuncture point tracking detecting

When doing acupuncture point position detecting, if massage head can't detect the effective shoulder height position, the actual shoulder height position was default to the middle part of back.

Right position: Your back cling to the chair back, the head clings to the pillow.



The remote control gives "beep" sound after acupuncture point tracking detecting finished, when micro-adjustment is needed, just press up/down key on the remote control.

- ✦ Avoid for the massage head detecting your acupuncture point position not right, otherwise you won't get good massage.

● Kind suggestion



- When you feel the intensity isn't strong enough, take off the pillow or cushion.

- Because the chair is heavy, it may ruin your floor in long time setting. Please put a blanket or other soft things to protect your floor.



Manual control



- Power On/Off
- Pause
- Backrest down
- Towards left adjust button
- Confirm button
- Legrest down
- Downward adjust button
- Heat button
- Intensity adjust button
- Auto button
- Manual button
- Telephone call button
- Time button
- Upwards adjust button
- Backrest up
- Towards right adjust button
- Legrest up
- Foot roller button
- Width adjust button
- Zero-G button
- Air pressure button

Massage operation

- 1. Press the on button on the remote. From there you can select a pre-set program or manual setting. In the manual setting you can select the duration of the massage. Prior to selecting a massage program you can sync your mobile or tablet device.
- 2. This button allows you to pause the massage and turn back on at your convenience.
- 3. The timing button allows you to select from 5mins, 10mins, 15mins, 20mins, 25mins, 30mins intervals.
- 4. In ON status, this button allows you to answer and end calls.
- 5. This button will recline the backrest at the same time raise the footrest.
- 6. This button raises the backrest and lowers the legrest.
- 7. This button lowers the legrest without moving the backrest
- 8. This button lowers the legrest without moving the backrest
- 9. In ON status and under Menu mode, press it to confirm menu choice and enter next menu.
- 10. This navigation pad allows you to select the functions much like a mouse of a computer, moving up, down, right and left.
- 11. The heat button activates the heating pad located in the backrest.
- 12. In ON status, press this button to adjust the massage speed, intensity and heating temperature. Select the desired mode, and relative screen display is glittering, and then you can press left/right button to adjust the massage speed, intensity and heating temperature.
- 13. In ON status, press this button is to adjust the massage width, and relative screen display is glittering on the controller, and then you can press left/right button to adjust the massage width.
- 14. In ON status, press this button to adjust foot roller massage speed : fast ,soft and stop .
- 15. In ON status, press this button to enter auto program menu.
- 16. In ON status, press this button to enter manual program menu.
- 17. In ON status, press this button to enter air massage menu
- 18. In ON or standby status, press this button, massage chair will go into zero-gravity position, press it again to return to default position.

Massage operation

LCD display graphic description

Main interface

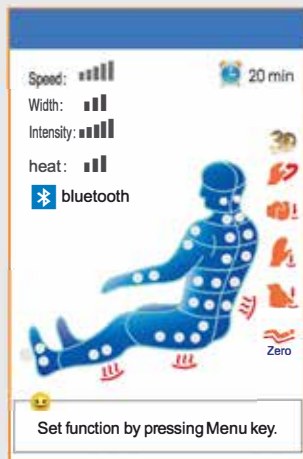

After power is on, press on/off key, the buzzer gives a short ring, the LCD screen will turn on, showing the display as shown on the left. The screen will show the massage method, time and current working status, etc., all of the information will in be real-time.

- Massage function
- 3D
 - Kneading
 - Tapping
 - Knocking
 - Shiatsu
 - Zero gravity
 - Massage time left

Massage position

- Massage speed (5 shifts)
- Massage width (narrow, mid, wide)
- Air intensity (5 shifts)
- bluetooth display
- Heating

Massage operation

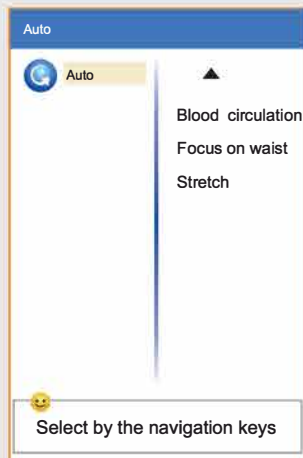

Auto massage: press "auto" in the main interface, the screen will display the auto massage interface. There are 10 massage programs to select from: power, sleeping, vitality mode, relax, comfortable mode, pain relief, muscle strengthen, blood circulation, focus on waist, stretch.

All pre-set massage programs will conduct a computer body scan. Soon as the computer body scan is complete, choose any one of the 10 programs, shoulder height detection is not needed any more.

Back/seat angle can be adjusted automatically. During auto massage, the back/seat angle will be automatically changed.

LCD display graphic description

Manual Massage: If the computer body scan doesn't complete, please restart the process again. In manual mode the computer body scan will activate unless "point" massage is selected.

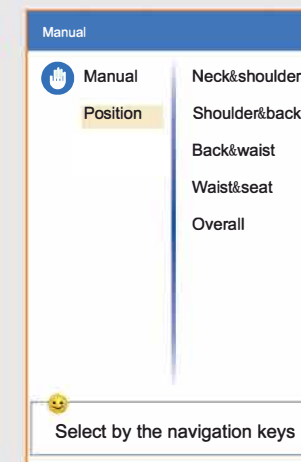

1. 7 massage methods: shiatsu, kneading, tapping, knocking, shiatsu (rolling), mix 1(Knead+Tap) and mix 2(Knead+Knock).
2. 5 positions for choice: Neck and Shoulder Mode: massage neck and shoulder
Shoulder and Back Mode: massage shoulder and back
Back and Waist Mode: massage back and waist
Waist and Seat Mode: massage waist and seat
Whole Body Mode: massage the whole body

During 3D Feel mode, only three positions are available, neck and shoulder mode, shoulder and back mode, back and waist mode.

3. Fixed Point
 - 1. The preset massage program default mode is whole body.
 - 2. Select massage method before choosing the position or fixed point.
 - 3. Select Manual mode, all air pressure massage will turn off.

Massage operation

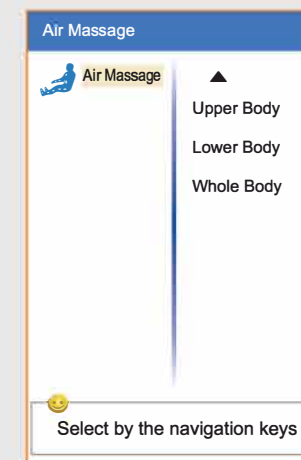
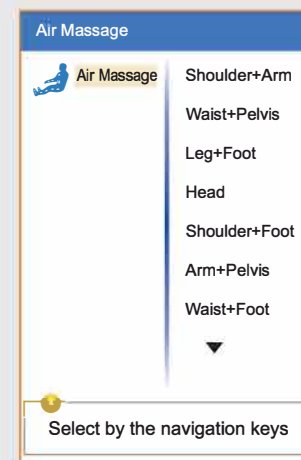

Air Massage: Ten air massage modes for you to choose, Shoulder+Arm, Waist+Pelvis, Leg+Foot, Head, Shoulder+Foot, Arm+Pelvis, Waist+Foot, Upper Body, Lower Body, Whole Body Mode. Once air massage is activated, the mechanical massage of the back massage machine shall stop.

ON/OFF

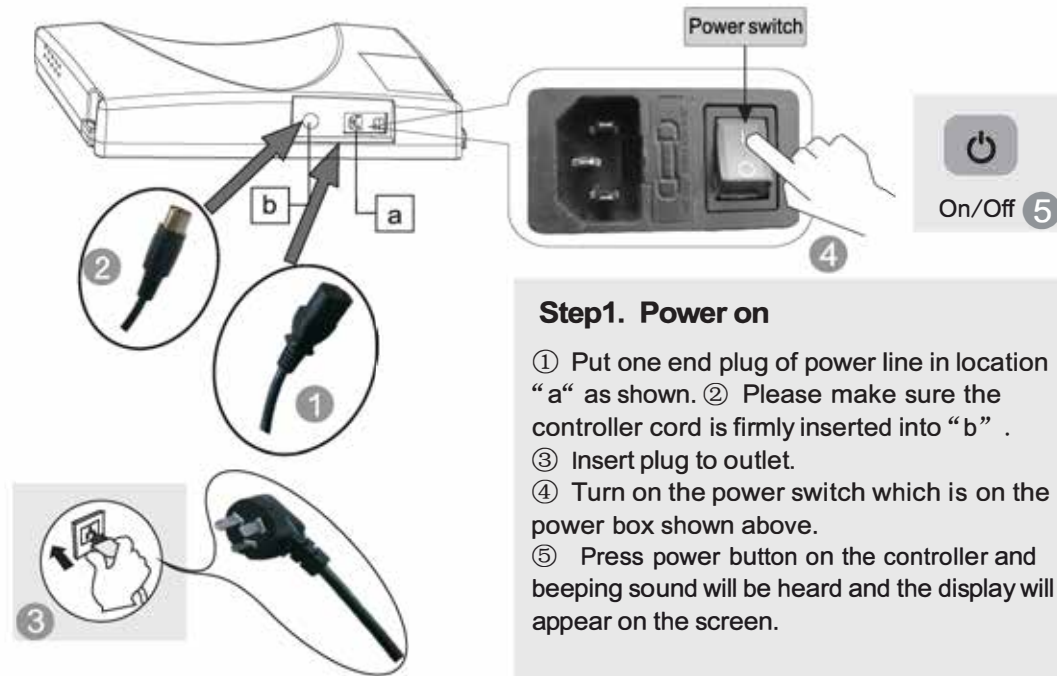
**Step1. Power on**

- ① Put one end plug of power line in location "a" as shown. ② Please make sure the controller cord is firmly inserted into "b".
- ③ Insert plug to outlet.
- ④ Turn on the power switch which is on the power box shown above.
- ⑤ Press power button on the controller and beeping sound will be heard and the display will appear on the screen.

Step2. Massage

- ① Operate by selecting the desired massage or function.
- ② When the massage stops, massage chair will return to the default position, meanwhile "Shutting down" displayed on the controller, will turn off.

**Step3. Turn off the power**

- ① When the chair is On, press On/Off button to turn off the massage chair and it will return to its default position.
- ② Turn off the power switch located on the back of the chair.
- ③ Unplug the power plug from the socket.

**Warning**

1. Before using, pull up the pillow, back cushion etc. to check if the PU material is broken, if there is damage, please stop using, unplug the chair, and ask for repairment.
2. Only plug to proper socket.

**Attention**

1. Before sitting down, make sure there is nothings pinched between armrest, legrest, backrest and seat of the chair.
2. Make sure the chair is in default position before using again.
3. Do not stand on the massage chair at any time.

Function Illustration

● Legrest up and backrest down

Press this button on controller, backrest will go down and legrest go up. Release this button, backrest and legrest will stop moving and the angle will be maintained.

**● Legrest extend and retract**

Legrest can extend or retract within a range of 15CM.

**● Backrest up and Legrest down**

Press this button on controller, backrest go up and legrest go down. Release this button, backrest and legrest stop moving, the angle is locked in this position.

**● Arm massage**

Put arms between arm airbags before the airbags begin to inflate. It will perform a squeezing massage to arms and hands.

**● Legrest Down**

Press this button on controller, legrest goes down. Release the button and the legrest will stop.

**● Shoulder massage**

Multilayer extrusion airbags is deployed on both sides of the shoulders achieving a stretching shoulder massage.

**● Legrest Up**

Press this button on controller, legrest goes up. Release the button, legrest will stop moving, the angle is locked in this position.

**● Foot roller massage**

At the bottoms of the foot massager foot rollers that apply a soothing kneading massage along the arches of the feet.

**● Zero gravity**

Press the button "Zero", backrest go down and legrest raise up, the chair go into Zero gravity status automatically. Press the Button again, the backrest and legrest stop moving, and it will lock at this position. However to change the angles, we can keep comfortable massage status all the time.

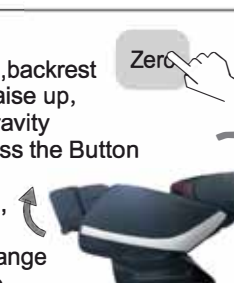

1. Please make sure there is no obstructions such as adults, kids, pets or objects are near when operating.
2. When adjusting the backrest, be careful that no part of the body fall into the gap between the backrest and armrest.
3. When the legrest is moving, please do not stand on footrest applying all your weight on the motor.

Restoration of massage chair

- 1 Make sure there is no people or pet or anything within the range of backrest and legrest.



- 2 Be sure to return the backrest and legrest to the default position by using controller. (or press ON/Off key to make backrest and legrest restore to the normal position)



- 3 After restoring, put the controller back into the pocket of the right armrest.



- 4 Put the pillow pad on to the right position.

- 5 Switch off the power.

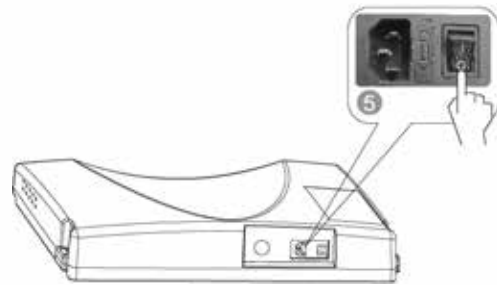

- 6 Unplug the electricity from the socket. (Attention: hold the right plug position)

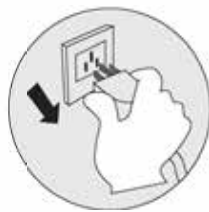

- 7 Clean the chair if necessary.



Attention!

- After using, press ON/OFF to end all the massage method and wait for restoration.
- Make sure to unplug the power to avoid any unexpected injury to children or pets.
- After using, turn off the power, unplug the electricity.

Synthetic leather

● General cleaning

Clean with a clean soft and dry cloth.



(Chemical or medical cleaning products are forbidden)



Forbidden



● If upholstery is dirty

- 1 Dip soft cloth into 3-5% neutral detergent solution, squeeze it then clean the stain on the surface gently.
- 2 Wash cloth, squeeze it and wipe with detergent.



- 3 Clean it softly with dry cloth.
- 4 Allow to dry (air blower is prohibited)

Cloth material

- 1 Dip cloth into weak neutral detergent, squeeze it and clean the surface & fabric.

- (Diluent, gas, alcohol are prohibited)
Brush the dirty parts with weak neutral detergent. (avoid excessive brushing)



Forbidden



- 2 Excessive cleaning may cause damage to cloth material.
- 3 Wipe with water-dipped but squeezed cloth.
- 4 Allow to dry.

Plastic parts

- 1 Dip cloth into neutral detergent, squeeze it and clean.
- 2 Wipe with water-dipped but squeezed cloth.
- 3 Allow to dry.



Clean the controller

- 1 Wipe with soft cloth after squeezing.
- 2 Allow to dry.
Propellant, diluent or alcohol are prohibited.



Forbidden



Controller



About cleaning

- Before cleaning, unplug the electricity, don't touch plug with wet hands.
- Make sure hands are dry when plugging to the socket.
- If you fail to follow the instruction you are risking potential serious injury.

FAQ and Troubleshooting

Trouble	Possible reason	Troubleshooting
The massage chair does not work after being powered on.	Check if the control is on or not.	Open control switch
	A massage function was not selected	Choose massage function
	check if the power cord is firmly inserted into the outlet and the chair.	Make sure plug and socket are connected.
	Wire or plug has been damaged.	Please ask manufacturer or appointed or authorized technician to inspect and repair.
	The fuse burned out.	Replace fuse of same specification.
	Something wrong with inner circuit	Please ask manufacturer or appointed certified technician to inspect and repair.
There is beep sound from the inside while working.	Sound is originating from air pump or motor.	This sound is normal once the chair has broken in.
Different height of the left roller and right roller.	The chair is working fine but slightly off level.	The arm or spring is bent or broken
Sound suddenly becomes much louder while working.	Check if the chair has been running for more than 60minutes	Turn off the power to have the massager rest for over half an hour before next usage.
Massage function suddenly stops while working.	Suddenly power-down timer has expired.	Turn off the power to have the massager rest for over half an hour before next turn working.
Neither the backrest nor the legrest can be lay down.	Check if there are any obstacles; the chair overloads; for the sake of safety, sometimes the massage machine may automatically stop working.	Remove the obstacles; turn off the power to have the massager rest for over half an hour before using again.
The chair can't return to its original position.	Excessive operation; the timer has expired	Please ask manufacturer or appointed or authorized maintenance man for checking and replacement.
Electric wire or plug is extremely hot.	The chair may be overused	Turn off the power to have the massager rest for over half an hour before using again.
	There may be an electrical issue	Stop using and call your manufacturer immediately. Be sure to unplug power



Note: If the troubles are not caused by above reasons, please turn off the power switch and cut off the power, then contact the manufacturer or service agent to repair your chair.

Technical data

Name	Massage Chair	Power	200 W
Model	RK7909	NW/GW	Main body :78/102 kg Armrest : 15.5/22kg Legrest & footrest : 15/17.5kg
Input voltage	<input type="checkbox"/> AC120V, 60Hz <input type="checkbox"/> AC220V, 50/60Hz <input type="checkbox"/> AC240V, 50Hz	Packing size	Main body: 1510×790×1030 mm Armrest : 1245×410×655 mm Legrest & footrest : 530 × 445 × 540 mm (L×W×H)
Safety design	Class I		