

Titan

SUMMIT FLEX SL-TRACK

INSTRUCTION MANUAL

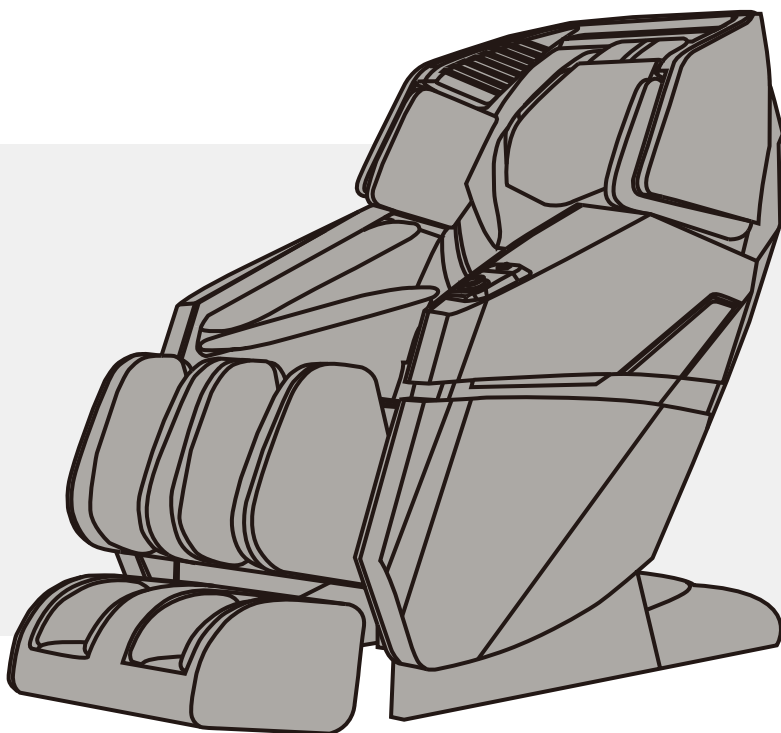

Please read all instructions carefully before using.

IMPORTANT SAFETY INSTRUCTIONS

Read all instructions before using (this appliance).

DANGER – To reduce the risk of electric shock:

1) Always unplug this appliance from the electrical outlet immediately after using and before cleaning.

WARNING – To reduce the risk of burns, fire, electric shock, or injury to persons:

1) An appliance should never be left unattended when plugged in. Unplug from outlet when not in use, and before putting on or taking off parts.

2) Do not operate under blanket or pillow. Excessive heating can occur and cause fire, electric shock, or injury to persons.

3) Close supervision is necessary when this appliance is used by, on, or near children, invalids, or disabled persons.

4) Use this appliance only for its intended use as described in this manual. Do not use attachments not recommended by the manufacturer.

5) Never operate this appliance if it has a damaged cord or plug, if it is not working properly, if it has been dropped or damaged, or dropped into water. Return the appliance to a service center for examination and repair.

6) Do not carry this appliance by supply cord or use cord as a handle.

7) Keep the cord away from heated surfaces.

8) Never operate the appliance with the air openings blocked. Keep the air openings free of lint, hair, and the like.

9) Never drop or insert any object into any opening.

10) Do not use outdoors.

11) Do not operate where aerosol (spray) products are being used or where oxygen is being administered.

12) To disconnect, turn all controls to the off position, then remove plug from outlet.

13) Do not use massager in close proximity to loose clothing or jewelry.

14) Keep long hair away from massager while in use.

15) Use heated surfaces carefully. May cause serious burns. Do not use over insensitive skin areas or in the presence of poor circulation. The unattended use of heat by children or incapacitated persons may be dangerous.

SAVE THESE INSTRUCTIONS

For use household only

Thank you for purchasing this product.

Please read this user manual carefully before using to ensure proper installation and operation.

Please keep this USER MANUAL properly for future reference.



CONTENTS

SAFETY PRECAUTIONS	1
NAME AND FUNCTION OF EACH COMPONENT.....	3
External Structure	3
Internal Structure.....	3
Power Box	4
Armrest Quick Button	5
Instructions of Armrest Quick Button	5
Controller	6
Controller Instructions	7
Display Screen Instructions	8
PRELIMINARY CHECKS.....	15
Position & Placement for Installation	15
Floor Protection.....	16
Surrounding Environment	16
Grounding	16
Installation Method	17
Moving the Massage Chair.....	20
Connecting to Power	20
Commissioning	21
Before Sitting in the Chair.....	21
After Use.....	21
PRODUCT STORAGE AND MAINTENANCE.....	22
TROUBLESHOOTING	23
TECHNICAL SPECIFICATIONS.....	23

SAFETY PRECAUTIONS

Safety Precautions

- ▶ Before using, please read the SAFETY PRECAUTIONS carefully to ensure correct operation of this appliance.
- ▶ Precautions and warnings listed below will help to ensure proper operation of this appliance.
- ▶ The classes of accidents caused by incorrect use are classified into WARNING and CAUTION. Read all WARNINGS and CAUTIONS below and follow all instructions within this manual.

	WARNING	Improper operation may cause injury to users.
	CAUTION	Improper operation may cause injury to users or damage to product.

	Prohibited		NO Disassemble
---	------------	---	----------------

Not suitable for below persons

We recommend that those with any of the following conditions should consult your physician before using.

 WARNING	<ul style="list-style-type: none"> ◆ Those with pacemaker or electronic devices implanted in the body. ◆ Those undergoing treatment, especially those who are not feeling well. ◆ Those with malignant tumors, acute disease, heart disease or severe hypertension. (Need to be supervised.) ◆ Those with osteoporosis, distorted joints, dysfunction or recent fracture. ◆ Those with serious or injured skin conditions. ◆ Those with high fever. ◆ The appliance has a heated surface. Persons insensitive to heat must be careful when using the appliance. (Need to be supervised) ◆ This appliance is not intended for use by persons (including children) with reduced physical, sensory or mental capabilities, or lack of experience and knowledge, unless they have been given supervision or instruction concerning use of the appliance by a person responsible for their safety. ◆ This appliance can be used by children aged from 8 years and above and persons with reduced physical, sensory or mental capabilities or lack of experience and knowledge if they have been given supervision or instruction concerning use of the appliance in a safe way and understand the hazards involved.
---	---

Controller Precautions

 CAUTION	<ul style="list-style-type: none"> ◆ Do not operate the controller with wet hands or pull the controller wire by force. ◆ Do not spill water or other liquid into the controller to avoid fault. ◆ Do not lay heavy items on the controller.
---	---

Cautions Regarding the Power Connectors and Power Cord





 CAUTION	<ul style="list-style-type: none"> ◆ The appliance is only to be used with the power supply unit provided with the appliance. ◆ It must only be supplied at safety extra low voltage corresponding to the marking on the appliance. ◆ Do not use a wet hand to unplug the AC cord to avoid electric shock. ◆ Do not pull on the power cord, reach to the front end to unplug it. ◆ Do not squeeze the power cord by heavy objects. ◆ Do not damage, over bend, pull hard or twist the power cord. ◆ If the supply cord is damaged, it must be replaced by the manufacturer or its service agent or a similarly qualified person in order to avoid a hazard.
---	--

SAFETY PRECAUTIONS

Best Circumstances

 CAUTION	<ul style="list-style-type: none"> ◆ Do not use this appliance where temperature is over 40 C. ◆ Do not use this appliance in moist or dusty environment. ◆ Unplug from outlet during thunder or lightning storms. ◆ Do not use outdoors. ◆ Please place the product on the flat level floor. ◆ Do not store near heat or open flame.
---	---

Best Practices for Safe Use

 CAUTION	<ul style="list-style-type: none"> ◆ Only for users weighs below 120kg. ◆ Do not use other therapeutic device together with this product. ◆ Use this product only for its intended use as described in this manual. ◆ Appliance should only be used by one person, do not use by two or more persons at the same time to avoid damage to the products. ◆ Do not use the product right after meal, it may cause discomfort. ◆ Remove the accessories from the arms and empty the pockets while use the massage services. ◆ Check the upholstery under the cushions and other spots, if any damages are present, do not use it and refer to a qualified service professional for servicing. ◆ If you feel any abnormal discomfort during the operation of this product, turn off the power immediately and do not use the product. ◆ Use the appliance for 20 minutes each time is highly recommended. ◆ Make sure there is no obstacles behind the chair and there is enough clearance before adjusting the backrest or footrest angle ◆ Make sure no other excessive load pressed on the backrest or footrest, keep children, pets or any other barrier away from the unit reclining backrest/extending footrest to prevent any accidental injury. ◆ Please be seated properly while using the appliance to avoid injury to the user or damage to the appliance. ◆ Do not drag or push the chair or roll on its casters on wood floor or carpet to avoid damage.
 PROHIBITED	<ul style="list-style-type: none"> ◆ Never operate this product if it has damaged /exposed parts or power leakage. ◆ Do not stand on or stack heavy objects on the footrest. ◆ Children should be supervised to ensure that they do not play with the massage chair. ◆ Do not fall into sleep while the product is operating. ◆ Avoid using the product under the influence of alcohol. ◆ Do not put hands or foreign objects in the openings of the appliance to avoid injury to the user or damage to the appliance. ◆ If there is any smoke or unusual smell during operation, stop using immediately.
 NO DISASSEMBLE	<ul style="list-style-type: none"> ◆ Do not disassemble this product to avoid failure. ◆ Do not attempt to repair or dismantle the appliance without permission. ◆ Please contact authorized dealer or service agent.
 UNPLUG POWER CORD	<ul style="list-style-type: none"> ◆ Pull out the power cord from the power strips before maintenance. ◆ Never plug in or pull out power cord with wet hand to avoid shock or injury. ◆ Pull out the power cord from the power strips after use. ◆ Unplug from outlet when the power supply is cut.

NAME AND FUNCTION OF EACH COMPONENT

External Structure

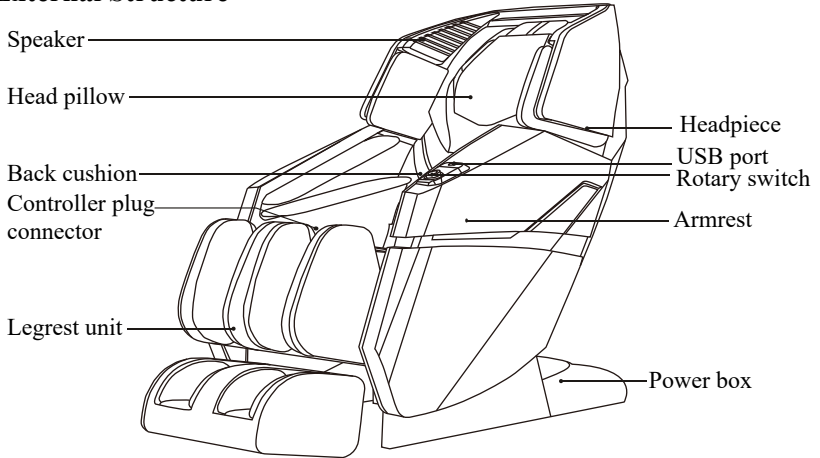

Internal Structure

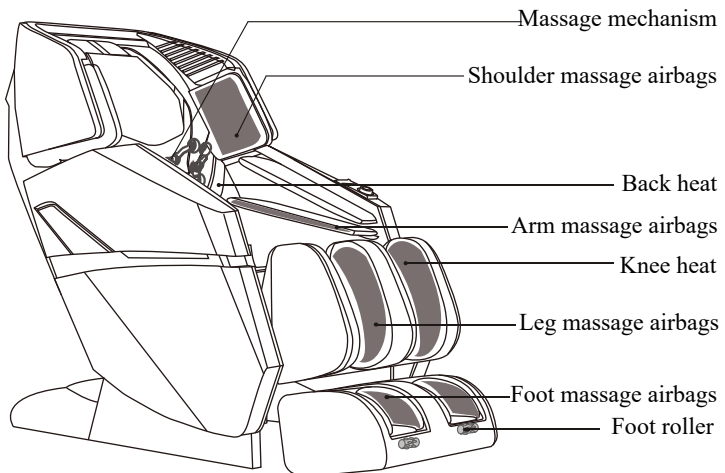

▶ NAME AND FUNCTION OF EACH COMPONENT

Power Box

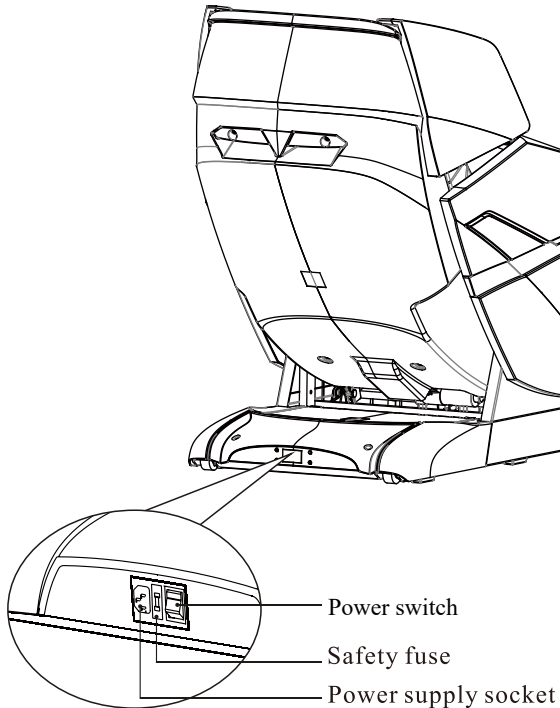

Caution

- ▶ Do not let children play on the chair in case that accident happens due to the power supply box.
- ▶ Please power off the chair and unplug the chair from the power supply socket after the massage finishes.
- ▶ Do not use the chair under thunders in rainy days.
- ▶ Please power off the chair and unplug the chair from the power supply socket when the chair is not in use, so that children won't accidentally get the chair started.
- ▶ Please store the chair if it is not in use for a long time.

▶ NAME AND FUNCTION OF EACH COMPONENT

Armrest Quick Button

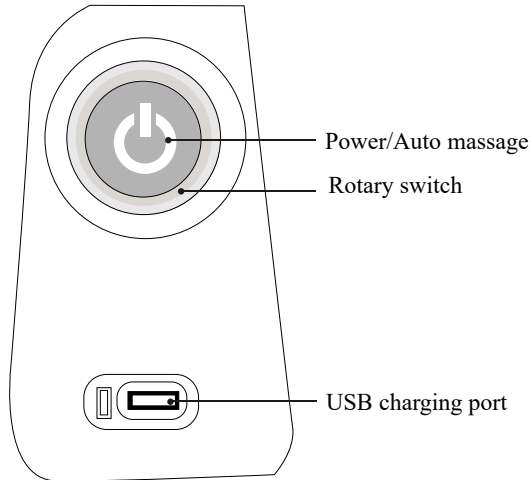

Instructions of Armrest Quick Button



Power/Auto massage

- ▶ Long press rotary switch to power on/off massage chair, quick press rotary switch to toggle among 6 auto massage programs.



Rotary Switch

- ▶ Slowly rotate clockwise to raise the backrest, Slowly rotate counterclockwise to recline the backrest.



USB charging port

- ▶ USB charging port works with 5V/9V/12V fast charging.

▶ NAME AND FUNCTION OF EACH COMPONENT

Controller

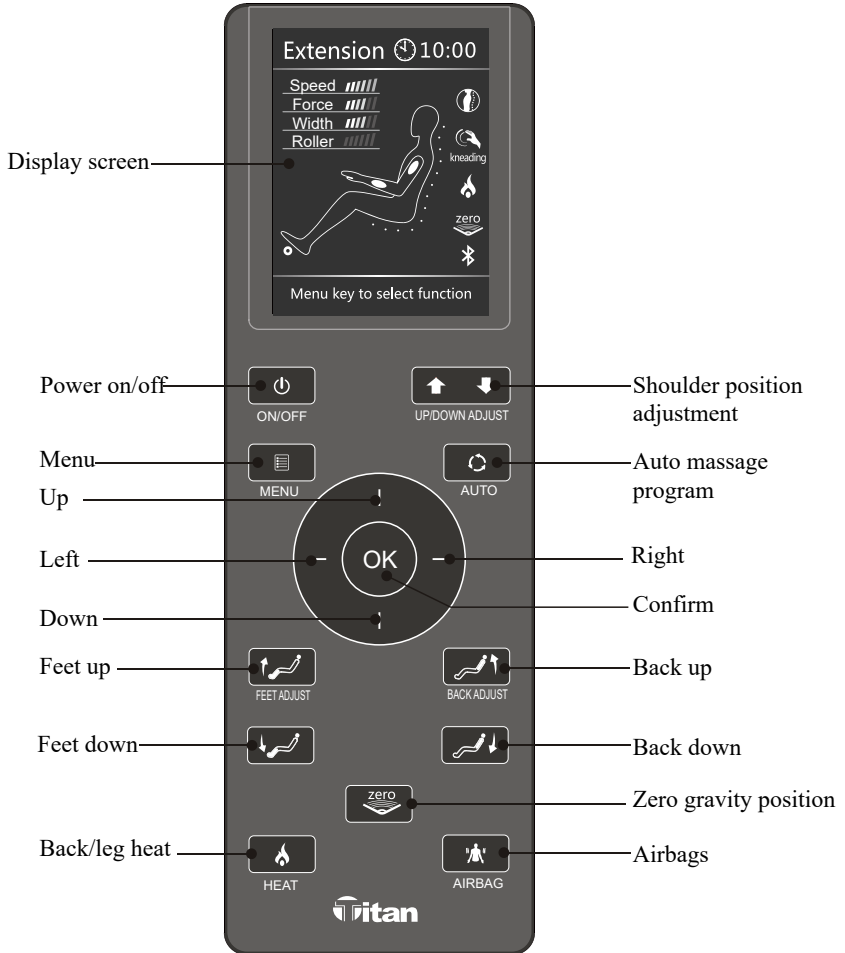

▶ NAME AND FUNCTION OF EACH COMPONENT

Controller Instructions



Power Button: Press this button to power on/off the controller.

- ▶ Press this button while connected to power to show the menu display, the LCD Screen is lit, use the UP/DOWN/LEFT/RIGHT buttons to navigate the screen, press OK to select.
- ▶ Press this button again to turn off the product. (The default massage timing is 20 minutes)



Menu Button

- ▶ Display the Auto Program, Manual Program, Airbag, Heat, Roller and Setting function. (Check the Display Menu for detailed information)



Shoulder Position Adjustment Button (Moves mechanism up and down)

- ▶ Press and hold Position UP/DOWN button to adjust the rollers to the desired position while in Manual-Spot massage mode.



Auto Program

- ▶ Display the auto mode menu. Press this button to toggle among the auto programs where users can choose among 4 massage categories named Feature, Classic, User and Focus according to their body status and time of day. The active program displays at the top of the status screen. (Check the Display Menu for detailed information)



Navigation Button

- ▶ Use the UP/DOWN/LEFT/RIGHT arrow buttons to navigate the screen, press OK to select.
- ▶ While massage program is running, press OK button to switch Zero Gravity position, press UP/DOWN button to change the Mechanism massage speed; press LEFT/RIGHT button to change the Airbag massage intensity.



Feet Up

- ▶ Press and hold to raise the footrest, release the button to stop.



Feet Down

- ▶ Press and hold to lower the footrest, release the button to stop.



Back Up

- ▶ Press and hold to raise the backrest, release the button to stop.



Back Down

- ▶ Press and hold to lower the backrest, release the button to stop.

▶ NAME AND FUNCTION OF EACH COMPONENT



Zero Gravity Button

▶ Press to set the chair in Zero Gravity Position, the Zero Gravity Position icon will be lit on display screen; press again to close the Zero Gravity Position, the Zero Gravity Position icon will be off.



Heat Button

▶ Press to turn On/Off back heat function, the heat indicator on display screen lights up/down accordingly.



Airbag Button

▶ Press AIRBAG to show the AIRBAG display, press RIGHT button then press UP or DOWN button to navigate between: PART-Air pressure region and FORCE-Air pressure intensity, Press OK button to enter the setting you desire.



WARNING

▶ After using, press Power button to restore the chair, press any button on the controller to stop the restoration, press Power button again for further operation.

Display Screen Instructions

▶ Auto message program

Display the auto mode menu. Press this button to toggle among the auto programs where users can choose among 4 message categories 12 programs named Feature (Extension, Release, Yoga), Classic(Thai, Chinese, Ancient), User(Boss, Lady, Senior) and Focus(Neck & Shoulder, Waist & Buttock, Back & Spine) according to their body status and time of day. The active program displays at the top of the status screen. (Check below display photo for reference)

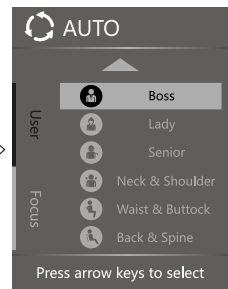
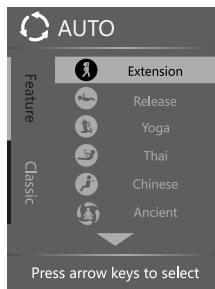
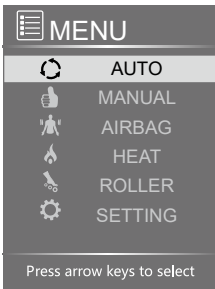

Extension

Extension Massage focuses primarily on full body stretching, double mechanism performs a combination massage techniques to relax and energize the body.

▶ NAME AND FUNCTION OF EACH COMPONENT

Release

Release Massage is a revitalizing massage ideal for de-stressing, relieving fatigue and improve metabolism.

Yoga

Uses moderate kneading and stretching techniques to relax tired muscles and keep them flexible.

Thai

Thai Massage focuses on the back and waist extension. Pressing,grabbing,kneading and rubbing massage techniques are used to help adjust the skeletal structure,increase flexibility and balance the body's energy system.

Chinese

By using kneading,pressing and rubbing massage techniques,Chinese Massage helps relax the lower back and release tension, soreness and tightness in the back muscles.

Ancient

Ancient Massage uses the combination of techniques and intensity to relax the body both physically and emotionally,it helps to speed up the healing of our injuries and relieve muscular and joint tension.

Boss

Boss Massage delivers a medium high intense massage focusing on relieving sore and tension and boosting confidence to handle problems.

Lady

Lady Massage adopts mild massage techniques to build strength,awareness and harmony in both the mind and body.

Seniors

Seniors Massage is a super soft massage session to relax muscles in the back,waist and hips,helping to maintain a balanced metabolism.

Neck&Shoulder

With combination of kneading,pressing and grabbing massage techniques, Neck&Shoulder Massage session helps to ease the pain and stiffness in the neck and shoulders.

Waist&Buttock

Designed to whine the waist and push the hip muscles,Waist&Buttock Massage session can lose hip fat and improve range of motion.

Back&Spine

Combination of deep tissue massage techniques; focuses on muscles along the spine, upper and lower back and lumbar.

▶ NAME AND FUNCTION OF EACH COMPONENT

▶ Manual Program Button

Press MANUAL from MENU display,press UP or DOWN button to navigate among: Mode,Part,Width,Speed and ZeroG.

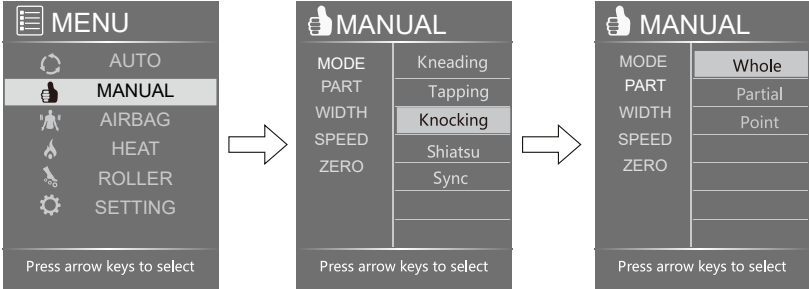

Message Mode: Press MODE from MANUAL display, press RIGHT button then press UP or DOWN button to navigate among:Kneading,Tapping,Knocking,Shiatsu and Sync message techniques. Press OK button to enter the setting you desire.Selected mode will show on the home screen.

Back Mechanism Message Part: Press PART from MANUAL display,press RIGHT button then press UP or DOWN button to navigate among:Whole,Partial and Point message regions.Press OK button to enter the setting you desire.

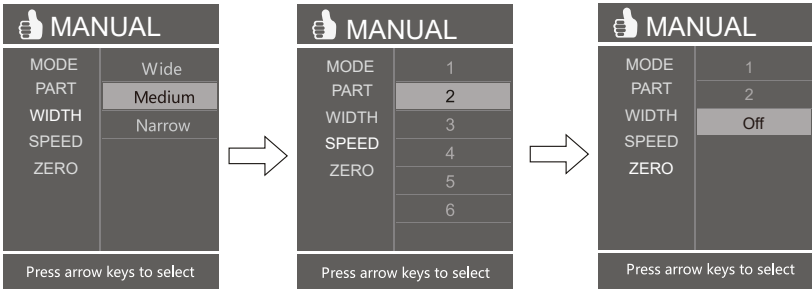

Back Mechanism Message Width:

Press WIDTH from MANUAL display,press RIGHT button then press UP or DOWN button to navigate among:Wide,Medium and Narrow mechanism roller width.Press OK button to enter the setting you desire.Selected width will show on the home screen. (Not adjustable in manual mode-kneading/sync)

▶ NAME AND FUNCTION OF EACH COMPONENT

Mechanism Massage Speed:

Press Speed from MANUAL display,press RIGHT button then press UP or DOWN button to navigate among:level 1,2,3,4,5,6 Mechanism massage speed.Press OK button to enter the speed level you desire.(Not adjustable in Shiatsu mode)

Zero Gravity Position:

Press Zero Gravity from Manual display,press RIGHT button then press UP or DOWN button to navigate among position1,2 or OFF (deactivate Zero Gravity). Press OK button to enter the setting you desire.

▶ Airbag:

Press Airbag from MENU display to show the AIRBAG display,press RIGHT button then press UP or DOWN button to navigate between:Part-Air pressure region and Force-Air pressure intensity,Press OK button to enter the setting you desire.

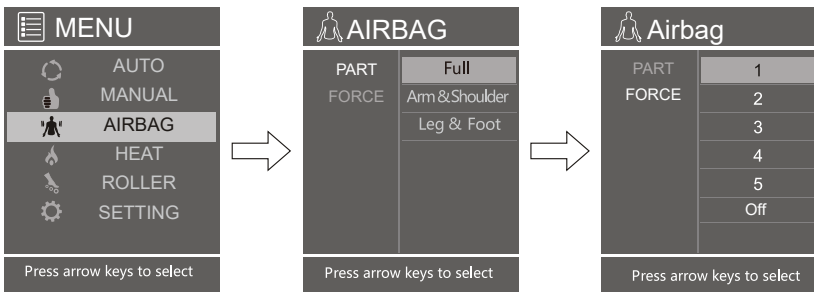

Part-Air Pressure Region

Press PART from AIRBAG display,press RIGHT button then press UP or DOWN button to navigate among:Full,Arm&Shoulder,Leg&Footpositions. Press OK button to enter the airbag position you desire.

Force-Air Pressure Intensity

Press FORCE from Airbags display,press RIGHT button then press UP or DOWN button to navigate among:1,2,3,4,5 air pressure intensity,or Off (deactivate airbag intensity function).press OK button to enter the airbag setting you desire.

▶ NAME AND FUNCTION OF EACH COMPONENT

▶ Back/Leg Heat

Press SETTING from MENU display,press OK button to enter Settings display,then press UP or DOWN button to navigate between:Back,Leg.

Back Heat

Back Heat-From Back Heat display,press UP or Down button to navigate among 1,2,3 heat level or Off(deactivate back heat function)

Leg Heat

Leg Heat-From Leg Heat display,press UP or Down button to navigate among 1,2,3 heat level or Off(deactivate leg heat function)

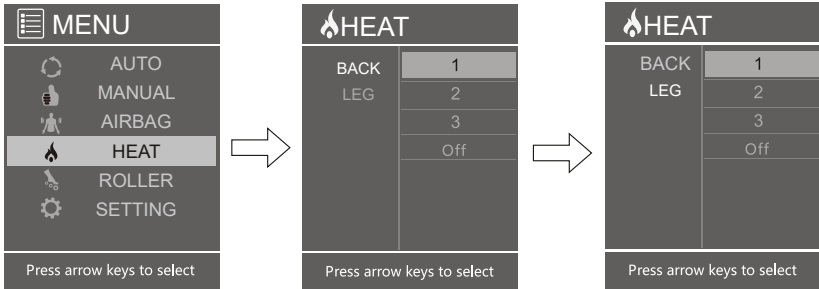

Foot Roller

Press ROLLER from MENU display,press RIGHT button then press UP or DOWN button to navigate among;foot roller speed level 1,2,3 or OFF (deactivate foot roller) . Press OK button to enter the speed level you desire.

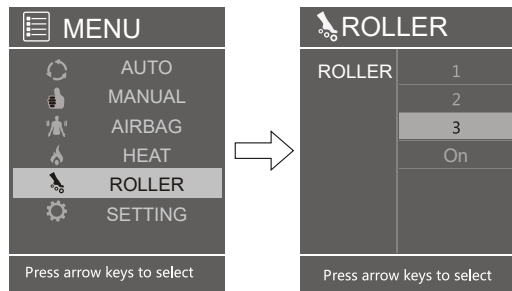

▶ NAME AND FUNCTION OF EACH COMPONENT

Settings

Press SETTING from MENU display,press OK button to enter SETTING display, then press UP or DOWN button to navigate among:TIME,LANGUAGE, BLUETOOTH.Press OK button to enter the setting you desire.

Time

Time:Press TIME from SETTING to show available timer: 10mins,20mins,30mins. press RIGHT button then press UP or DOWN button to navigate,press OK button to enter the timer you desire, 20mins is the default setting.

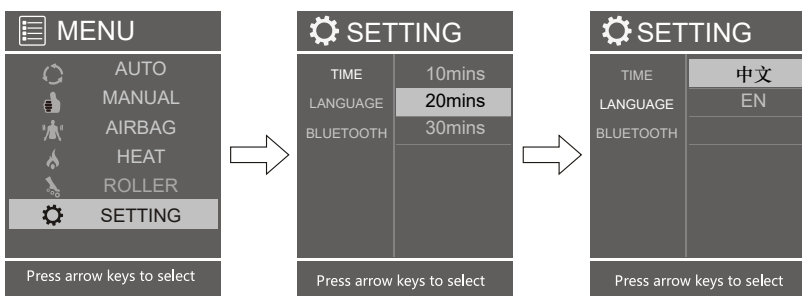

Language:

Press LANGUAGE from SETTING to show available language: 中文, EN.press RIGHT button then press UP or DOWN button to navigate,press OK button to enter the language you desire.

Bluetooth :

Press BLUETOOTH from SETTING display,press RIGHT then press UP or DOWN button to turn On/Off Bluetooth,Press OK button to enter the setting you desire.

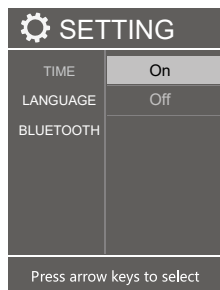

▶ NAME AND FUNCTION OF EACH COMPONENT

Note:

1 In the process of Auto or Manual Setting,LCD screen will auto revert back to the homescreen after 10 seconds if there is no operation entered into the controller.

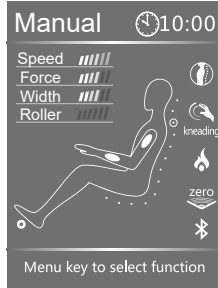

Homescreen display with the Manual program running

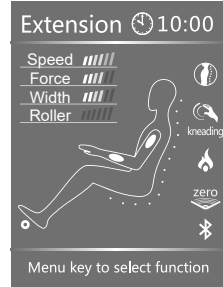

Homescreen display with the Auto program running

⚠ Tips

- ▶ While appliance is running,press twice MENU button to revert to homescreen.
- ▶ At the homescreen display,press LEFT or RIGHT button to adjust the airbag intensity(works in the process of both Auto and Manual program);press UP or DOWN button to adjust the massage intensity(only works in the process of Manual program)
- ▶ Press Auto button to select auto massage program.

2 Mechanism will scan shoulder position before first time running of Auto Program (check the right figure),it will start to run the desired auto program right after the completion of scanning.

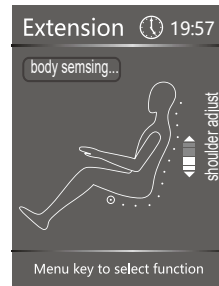

⚠ CAUTION

- ▶Do not disassemble this product yourself to avoid product damage.
- ▶Make sure no water or other liquid enters into the controller to avoid fault.
- ▶Do not pinch or squeeze the controller or power cord.

► PRELIMINARY CHECKS

Position & Placement for Installation

Clearance space for the massage chair:

- Ensure there is an adequate clearance for the installation: It needs 15cm clearance for the reclining of the backrest; It needs 20cm clearance space for the extension of footrest and sliding forward of the chair.
- Keep it 1 meter away from the TV, radio or other audio/video appliance to avoid signal interference.

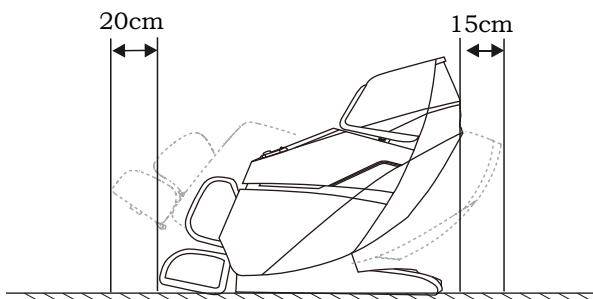

- Keep the distance between the power socket and power switch within 1.5 meter.

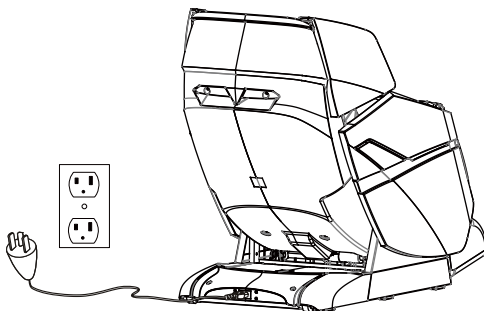

CAUTION

- Keep the distance between the power socket and power switch within 1.5 meter to avoid damage of power cord while massage chair sliding forward.
- Straighten the power cord while in use to avoid tangle or damage.
- When the massage chair sliding forwards or back, please check to make sure there are no children, pets or other obstacles around to avoid accident.

▶ PRELIMINARY CHECKS

Floor Protection

- ▶ We recommend to place a piece of carpet or soft mat underneath it to avoid damaging the floor.

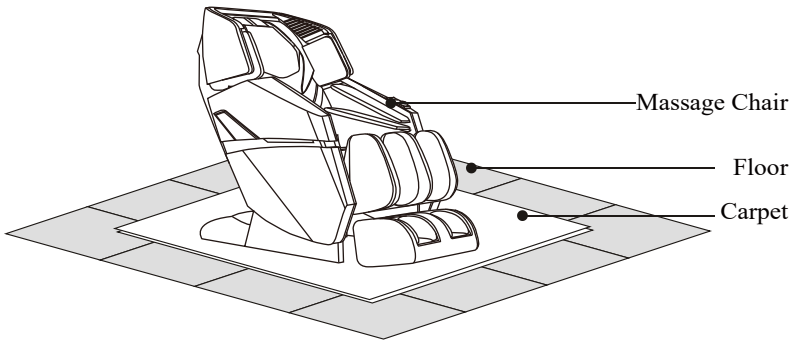

Surrounding Environment



Do not use the massage chair in high moisture environment such as near swimming pool or bathroom to prevent electric shock accident.



Please keep the massage chair away from heated surfaces to prevent fire hazard or damage to the product.

Grounding



This product must be grounded, the plug must be plugged into an appropriate 3-wire grounded outlet that is properly installed and grounded in accordance with all local codes and ordinances to reduce risk of electrical shock.

▶ PRELIMINARY CHECKS

Installation Method

Step 1, Take all massage chair units out of the cartons

Unpack the cartons and take out all sewing and other accessories out of the cartons. Before beginning installation, please verify that all components are included (check with the packing list carefully)

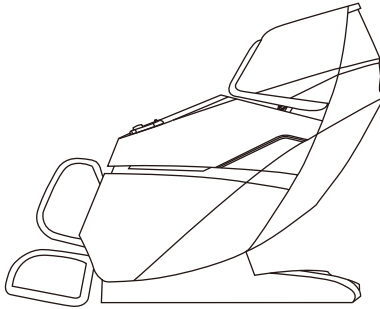

Step 2, Install the Controller

Connect the controller cable to the massage chair's plug connector (line up the pins with the port before connection), then tighten the screw cap clockwise to secure the connector in place.

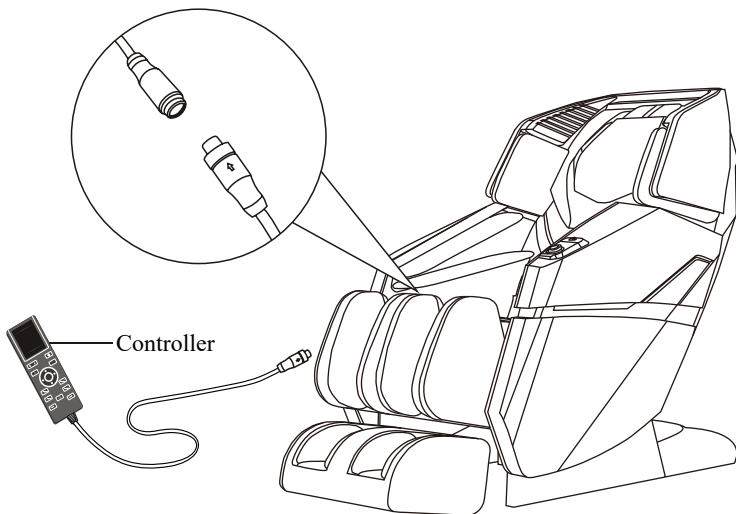

▶ PRELIMINARY CHECKS

Step 3, Install the Footrest Unit

- ▶ Lift the Footrest Massage Unit, fit the legrest bracket of the footrest unit onto the chair body pin located at the seat base (Keep the bracket leveled with the pin), connect one side first then the other.

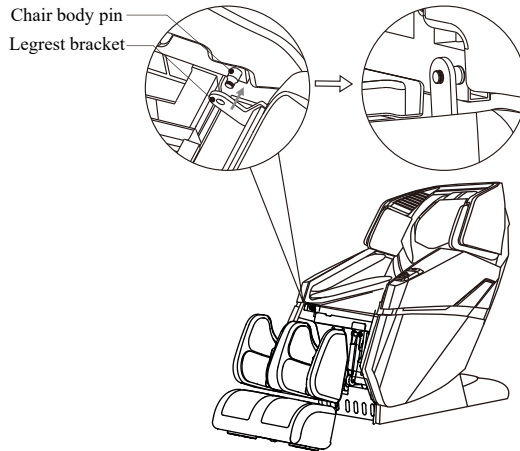

- ▶ Attach a legrest clip to the end of the chair body pin to hold the legrest in place.

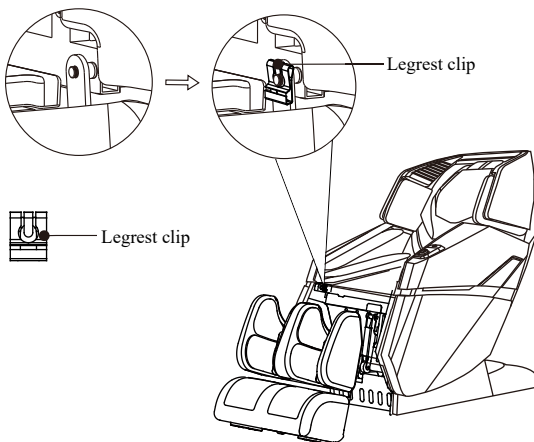

PRELIMINARY CHECKS

Step 4, Install the Footrest Unit

- ▶ Raise the footrest unit, thread the Air Hoses into the Air Nozzle, and fit the Air Valve plug into the Air Valve Port which located at the face side of seat base, make sure they are well secured. (Check the illustration below for reference)
- ▶ Zip up the cover and cushion.

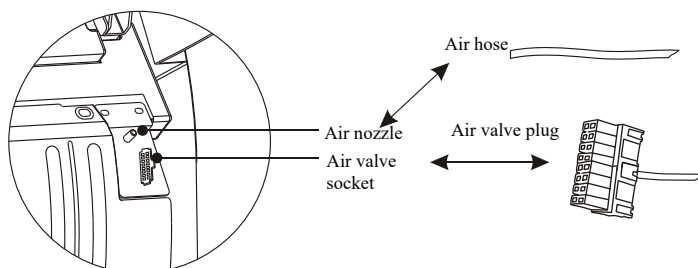

- ▶ Connect the power cable to the product power connector port located at the power box of the product. (Check the illustration below)

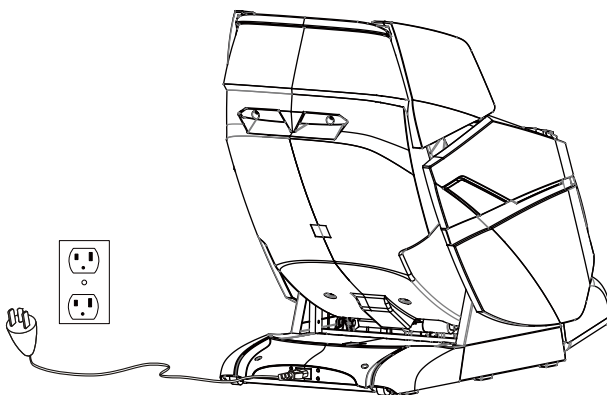

▶ PRELIMINARY CHECKS

Moving the Massage Chair

- ▶ Roll the chair on its casters to the desired location.
- ▶ Incline the backrest to upright position.
- ▶ Turn off the power switch and unplug the appliance from the electrical outlet.
- ▶ Using two people, push down on the backrest and lift up on the front side by grabbing the moving Holder located to the front bottom of the armrest, roll the chair on its casters to the desired location (check the sketch for reference).

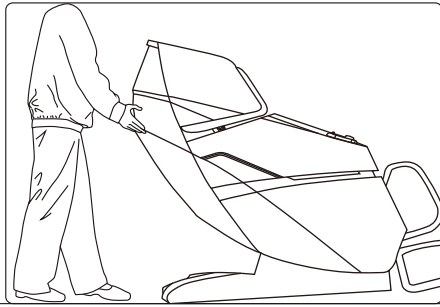

CAUTION

- ▶ Do not move the chair when there is user inside.
- ▶ To carry this product, do not lift by the footrest or armrest, hold the chassis and steady the backrest (have 4 or more people to carry the product).

Connecting to Power

- ▶ Connect this appliance to a 3-wire properly grounded outlet.
- ▶ Turn on the main power switch by the right hand side of the massage chair.

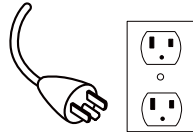

CAUTION

- ▶ Please verify that there is no damage to the supply cord before switching on the massage chair.
- ▶ Please verify that the main power switch is turned off before connecting to power.

▶ PRELIMINARY CHECKS

Commissioning

- ▶ Use the controller to recline the backrest to its lowest position, raise and extend the footrest to its top position, make sure there is enough clearance before commissioning.
- ▶ Return the backrest and footrest back to its default position after commissioning and turn off the power switch. To choose the massage program, please check the Instructions of Control Panel and Instructions of Touchscreen Controller for reference.

Before Sitting in the Chair

- ▶ Ensure the footrest is well assembled before sitting on the massage chair.
- ▶ Ensure the massage chair is returned to its original position before sitting on it.
 - ▶ If there is any part not in default position, please turn off the massage chair to allow it to restore.



CAUTION

- ▶ Do not take seat while the legrest is lifted.
- ▶ Do not put excessive load on the legrest to avoid damage.

After Use

- ▶ Turn off the power switch and unplug the massage chair from the electrical outlet while not in use to avoid children power on the massage chair accidentally.
- ▶ When not in use for a long period of time, we recommend that the chair be covered, the power cord be coiled and that the unit be placed in an environment free of dust and moisture.

CARE AND MAINTENANCE

Care Instructions

- ▶ To treat stains on back panel, armrest, footrest, plastic parts or air hose, spot clean with mild detergent foam, then wipe it with a dry cleaning cloth.
- ▶ To treat stains on controller, power box, spot clean with a dry cleaning cloth.
- ▶ To treat stains on back cushion or pillows, use a water-based upholstery cleaner only, wipe it with moist cloth, then air dry.
- ▶ To clean the foot/calf unit covers, remove it from the chair, hand wash with a mild detergent, then line dry.



WARNING

- ▶ Children shall not play with the appliance. Cleaning and user maintenance shall not be made by children without supervision.
- ▶ Pull out the power cord from the power strips before care and maintenance.
- ▶ To avoid electrical shock or injury, do not touch the power cord with wet hands.
- ▶ Make sure no detergent enters into the power box while cleaning.
- ▶ Do not use benzene, thinner or other solvents on your product, it may cause fading or damage to the product.
- ▶ Do not iron the upholstery.

Storage Methods

- ▶ Cover the product with a dust-free cloth to prevent collection of dust if not in use for a long period of time.



CAUTION

- ▶ Do not leave this product exposed to direct sunlight for long periods of time. This may cause fading or damage.

Warm Tips

During daily use, please check for the following symptoms:

- ▶ Burnt smell.
- ▶ Power flickers on and off when touching the charging cable.
- ▶ The power cord is hot.
- ▶ Other abnormal symptoms.



CAUTION

- ▶ Please stop using the product to avoid breakdowns or accidents if any of the above symptoms exist.
- ▶ Switch off the power button and disconnect the plug, contact the local distributors or supplier for repair.
- ▶ All other servicing except above care and maintenance should be serviced by an authorized dealer or service center.



WARNING

Pull out the power cord from the power strips before care and maintenance.

To avoid electrical shock or injury, do not touch the power cord with wet hands. Do not try to dismantle or repair the product yourself, please send your massage chair to the authorized service center.

▶ TROUBLESHOOTING

No.	Symptoms	Possible Causes	Possible Solutions
1	Noise is heard while in use	This sound is normal and comes from the air pump motor or other mechanical parts rubbing against the cloth cover	No need to take any measures
2	Appliance does not start	The power cord is not secured into the socket	Insert the power plug properly into the power socket
		Power switch is off	Turn on the switch
		The fuse is blown	Replace only with a fuse of same type and rating
3	No music comes from the speaker	The volume is turned to the lowest	Adjust the speaker volume from the mobile devices
		Bluetooth is off	Switch on Bluetooth
		Bluetooth connected with other device	Reconnect Bluetooth

If problem remains, please contact the dealer for maintenance.

Important: Do not attempt to repair this product yourself, our company shall not be liable for the injury or damage caused by any servicing without authorization.

▶ TECHNICAL SPECIFICATIONS

Product name: Titan Massage Chair
Model number: Summit Flex SL-Track
Rated voltage: 110-120V~
Rated frequency: 60Hz
Rated current: 0.8A

▶ GROUNDING INSTRUCTIONS

This product must be grounded. If it should malfunction or breakdown, grounding provides a path of least resistance for electric current to reduce the risk of electric shock. This product is equipped with a cord having an equipment-grounding conductor and a grounding plug. The plug must be plugged into an appropriate outlet that is properly installed and grounded in accordance with all local codes and ordinances.

DANGER – Improper connection of the equipment-grounding conductor can result in a risk of electric shock. Check with a qualified electrician or serviceman if you are in doubt as to whether the product is properly grounded. Do not modify the plug provided with the product – if it will not fit the outlet, have a proper outlet installed by a qualified electrician.

This product is for use on a nominal 120 V circuit and has a grounding plug that looks like the plug illustrated in sketch A in following figure. Make sure that the product is connected to an outlet having the same configuration as the plug. No adapter should be used with this product.

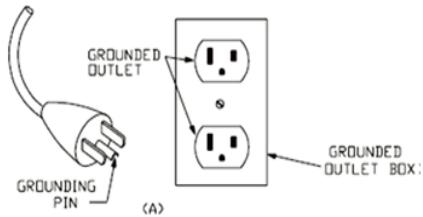

Earthing

This massage chair belongs to Level One electrical appliance, make sure to use three-core power supply socket and to guarantee the ground wire connected to the power supply socket has obtained good ground connection to avoid electric leakage, electric shock and some other negative effect during use

