

Osaki

Avalon 4D
MASSAGE CHAIR
OPERATION INSTRUCTIONS

SAVE THESE INSTRUCTIONS

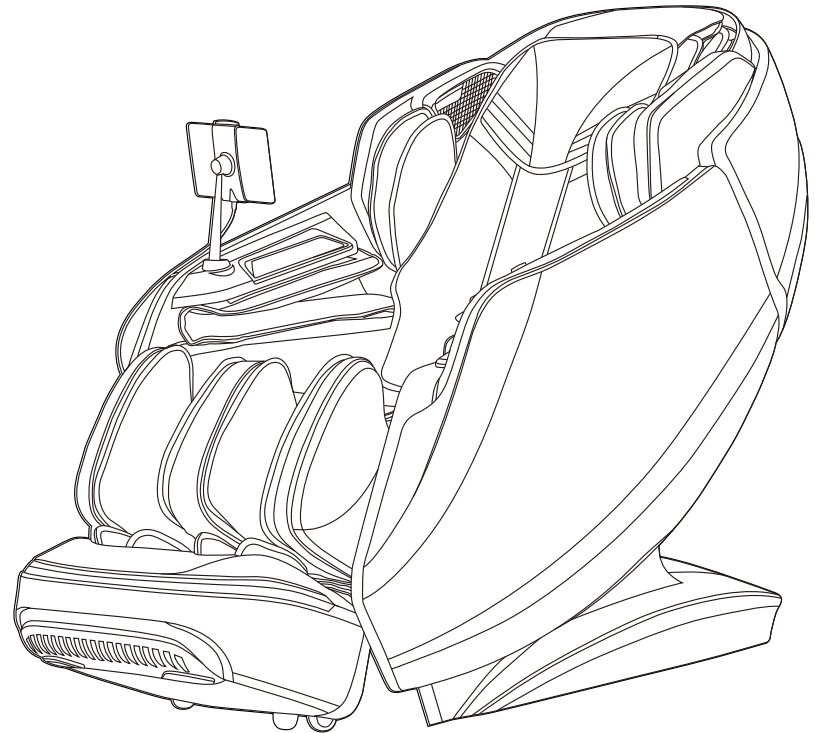

Thank You for purchasing this product. Please read this manual instruction carefully in order to know how to use this product correctly before operation. Please pay more attention to the important safety warnings and keep this manual book properly for future use.

Note: We reserve the right to change the design and manual of the product. Details are subject to change over time, and will not be informed otherwise. If there are some differences between the products in the market circulation and the description in the manual, it is a normal update of the product. Specific product functions and colors are subject to change at any time.

CONTENTS

Before Use

Important Safety Instruction -----	02-03
Instructions De Securite Importantes -----	04-05
Installation Parts -----	06-07
Place Massage Chair -----	08-09
Before Use -----	10-11
Product Structure -----	12-18

Usage Method

Operation Instructions -----	19-53
Massage close -----	53

Maintain

Cleaning and Maintenance -----	54
--------------------------------	----

Important

Troubleshooting -----	55
Product Specifications -----	56

Important Safety Instruction

When using an electrical appliance, basic precautions should always be followed, including the following:

Read all instructions before using (this appliance)

DANGER-To reduce the risk of electric shock:

1) Always unplug this appliance from the electrical outlet immediately after using and before cleaning.

WARNING-To reduce the risk of burns, fire, electric shock, or injury to Persons:

- 1) An appliance should never be left unattended when plugged in. Unplug from outlet when not in use, and before putting on or taking off parts.
- 2) Do not operate under blanket or pillow. Excessive heating can occur and Cause fire, electric shock, or injury to persons.
- 3) Close supervision is necessary when this appliance is used by, on, or near children, invalids, or disabled persons.
- 4) Use the appliance only for its intended use as described in this manual. Do not use attachments not recommended by the manufacturer.
- 5) Never operate this appliance if it has a damaged cord or plug, if it is not working properly, if it has been dropped or damaged, or dropped into water. Return the appliance to a service center for examination and repair.
- 6) Do not carry this appliance by supply cord or use cord as a handle.
- 7) Keep the cord away from heated surfaces.
- 8) Never operate the appliance with the air openings blocked. Keep the air openings free of lint, hair, and the like.
- 9) Never drop or insert any object into any opening.
- 10) Do not use outdoors.
- 11) Do not operate where aerosol (spray) products are being used or where oxygen is being administered.
- 12) To disconnect, turn all controls to the off position, then remove plug from outlet.
- 13) The appliance is intended for household and indoor use only.

Important Safety Instruction

- 14) Connect this appliance to a properly grounded outlet only ,see grounding instructions .
- 15)Keep children away from extended foot support (or other similar parts
- 16)Do not use massager in close proximity to loose clothing or jewelry.
- 17)Keep long hair away from massager while in use.
- 18)Connect this appliance to properly grounded outlet only. See Grounding Instructions.

SAVE THESE INSTRUCTIONS GROUNDING INSTRUCTIONS

This product must be grounded, if it should malfunction or breakdown, grounding provides a path of least resistance for electric current to reduce the risk of electric shock, this product is equipped with a cord having an equipment grounding conductor and a grounding plug, the plug must be plugged into an appropriate outlet that is properly installed and grounded in accordance with all local codes and ordinances.

DANGER: Improper connection of the equipment grounding conductor can result in a risk of electric shock, check with a qualified electrician or serviceman of you are in doubt as to whether the product is properly grounded, do not modify the plug provided with the product-if it will not fit the outlet, have a proper outlet installed by a qualified electrician.

1)This product is for use on nominal 120-volt circuit, and has a grounding plug that looks like the plug illustrated in sketch on the page 50, A temporary adapter that looks like the adapter illustrated in sketches B and C may be used to connect this plug to a 2-pole receptacle as shown in sketch B if a properly grounded outlet is not available the temporary adapter should be used only until a properly grounded outlet (shetch A)can be installed by a qualified electrician, the green colored rigid ear, lug, or the like extending from the adapter must be connected to a permanent ground such as a properly grounded outlet box cover, Whenever the adapter is used, it must be held in place by a metal screw.

Instructions De Securite Importantes

lors de l'utilisation d'un appareil électrique, des précautions de bases doivent être respectées, y compris ce qui suit :

Lisez toutes les instructions avant d'utiliser l'appareil.

DANGER- Pour réduire le risque de choc électrique:

- 1) Toujours débrancher cet appareil de la prise électrique immédiatement après usage et avant nettoyage

AVERTISSEMENT- Pour réduire le risque de brûlures, d'incendie, de choc électrique ou de blessures:

- 1) Cet appareil ne doit jamais quitter votre surveillance lorsqu'il est branché. Débranchez-le de la prise lorsqu'il est inutilisé, et avant de placer ou d'enlever des pièces.
- 2) Ne pas utiliser cet appareil sous une couverture ou un oreiller. Une chaleur excessive peut provoquer un incendie, un choc électrique ou des blessures corporelles.
- 3) Soyez prudent et maintenez une surveillance accrue lorsque cet appareil est utilisé par, sur, ou près des enfants, de personnes invalides ou handicapées.
- 4) Utilisez l'appareil uniquement pour un usage habituel, comme décrit dans ce manuel. Ne pas utiliser d'accessoires non recommandés par le fabricant.
- 5) Ne jamais faire fonctionner cet appareil si le cordon ou la fiche sont endommagés, s'il ne fonctionne pas correctement, s'il est endommagé ou s'il est tombé dans l'eau. Retournez l'appareil au service technique pour examen et réparation.
- 6) Ne transportez pas cet appareil par le cordon d'alimentation ou d'utilisation comme une poignée.
- 7) Gardez le cordon loin des surfaces chauffées.
- 8) Ne jamais faire fonctionner l'appareil en obstruant les ouvertures d'air. Gardez les ouvertures à l'air, libre de peluches, de cheveux, etc.
- 9) Ne jamais laisser tomber, ou insérer d'objet dans les ouvertures.
- 10) Ne pas utiliser à l'extérieur.
- 11) Ne pas utiliser dans les lieux où des aérosols (vaporisateurs) sont utilisés, ni là où l'oxygène est administré.
- 12) Pour débrancher, mettre tous les boutons de l'appareil sur la position arrêt, puis retirer la fiche de la prise.
- 13) L'appareil est destiné à un usage domestique et à l'intérieur seulement.
- 14) Connectez cet appareil à une prise correctement reliée à la terre. Voir les instructions de mise à la terre.

Instructions De Securite Importantes

15) Éloignez les enfants du support de pied ouvert (ou des autres pièces semblables).

16) Ne pas utiliser de massage à proximité des vêtements amples ou des bijoux.

17) Garder les cheveux longs à l'écart de masseur en cours d'utilisation.

18) Raccordez cet appareil à une prise correctement mise à la terre.

CONSERVER CES INSTRUCTIONS INSTRUCTIONS DE BASES

Ce produit doit être relié à la terre. Si il dysfonctionne ou tombe en panne, la terre fournit un chemin de moindre résistance pour le courant électrique afin de réduire le risque de choc électrique. Cet appareil est équipé d'un cordon avec un conducteur de mise à la terre des équipements et une prise de terre. La fiche doit être branchée dans une prise appropriée qui est correctement installée et mise à la terre conformément à la réglementation locale.

DANGER: un mauvais branchement de l'équipement à la prise de terre, peut entraîner un risque de choc électrique. Consultez un électricien qualifié si vous avez des doutes quant à savoir si le produit est correctement mis à la terre. Ne pas modifier la fiche fournie avec le produit si elle ne rentre pas dans la prise. Adressez vous à un électricien qualifié le cas échéant.

1) Ce produit est destiné à être utilisé sur un circuit de 120 volts, et possède une fiche de mise à la terre semblable à la fiche illustrée sur le croquis de la page 50. Un adaptateur temporaire qui ressemble à l'adaptateur illustré sur le croquis B et C peut être utilisé pour brancher cette fiche à un réceptacle 2-pole, comme indiqué sur le croquis B. Si une prise de terre n'est pas disponible, l'adaptateur temporaire ne doit être utilisé que jusqu'à une prise de terre correcte (croquis A) pour être installé par un électricien qualifié. L'oreille rigide de couleur verte, qui dépasse de l'adaptateur, doit être connectée à une terre permanente comme un couvercle de boîte de sortie mise à la terre. Chaque fois que l'adaptateur est utilisé, il doit être maintenu en place par une vis en métal.

**S'il vous plaît noter que lorsque ne pas coincer votre détection des doigts
Avant le nettoyage ou la réparation doivent couper l'alimentation**

Installation Parts

Armrest Installation Instructions

1. After power on, use the remote controller to lie down the backrest .
2. Insert the wire harness and air pipes on the side of the steel frame into the corresponding positions on the armrest (Figure 1).
3. Lift up the armrest with the air pipes and wires inserted, and hang all the hooks on both sides of the steel frame (Figure 2).

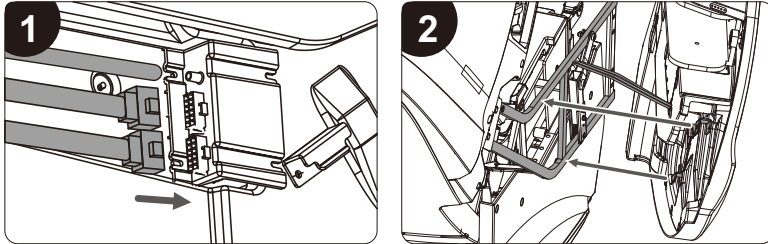

4. Press the roller at the rear end of the armrest into the corresponding slot (Figure 3), and lower the armrest downwards. Then push the armrest backwards, and lock it with 2 M6*16 screws (Figure 4).

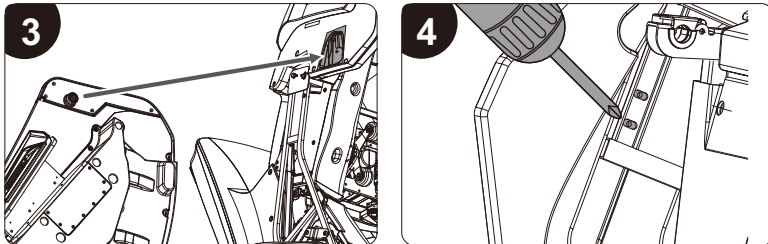

Installation Parts

Calf Installation Instructions

1. Insert the wires and air pipes of the footrest into the front sockets of the steel frame assembly respectively (Figure 1).
2. After the wire connection is completed, open the fixing covers of the footrest on both sides of the steel frame assembly (Figure 2).
3. Lift the footrest, put them into the slot, then flip the fixing cover down, fixing them with two M5*12 screws (Picture 3).

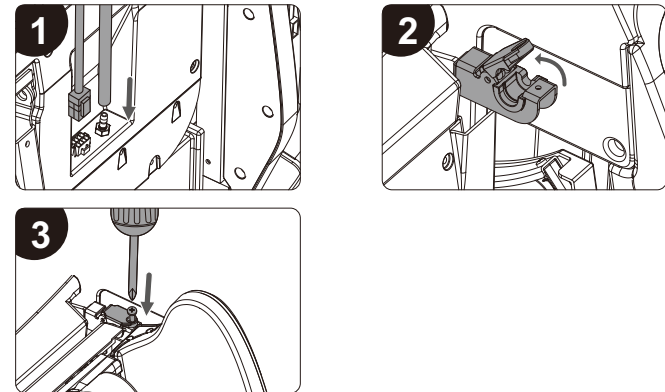

Touchscreen Remote Controller Bracket Installation Instructions

1. Align the bracket with the front hole of the armrest (right) and fasten it with M5*16 screws (Figure 1).
2. Align the bracket decoration with the bracket and press down along the bracket rod to the end. (figure 2).
3. After the entire bracket is installed, shake the bracket lightly to confirm whether it is firmly installed; the bracket installation is complete (Figure 3).

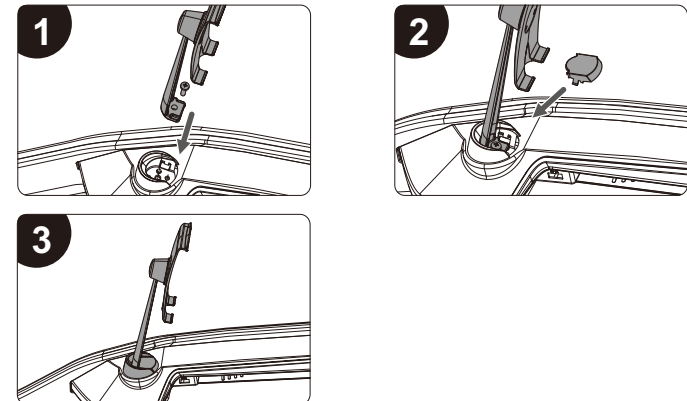

Place Massage Chair

Installation placement

Make sure there is enough space for the massage chair to be tilted at least 4 inches.



Caution

Do not expose the massage chair directly to high temperature environment due to sunlight (such as: in front of heating equipment), and place it to where can avoid high temperature and direct sunlight. It is recommended to lay a soft cushion for long-term use in a designated location. When laying the cushion, the size of the cushion should be enough to cover the range where the machine touches the floor and the range where your feet touch the floor.

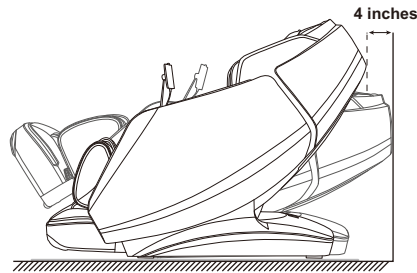

Product lift instruction

Require team work to lift and move the chair to avoid injury.



Caution

1. Please lift the massage chair to move it on vulnerable ground such as wooden floor.
2. When moving on a similar wooden floor, it is recommended to lift it. Avoid damage to the casters. When the floor is lifted and moved to the designated position, be careful to keep your hands out of the way to avoid injury, and be careful of your feet being crushed. Do not let go of the unit until the unit is completely flat, the floor may be damaged, therefore, it is recommended to place mats, etc. on the floor.

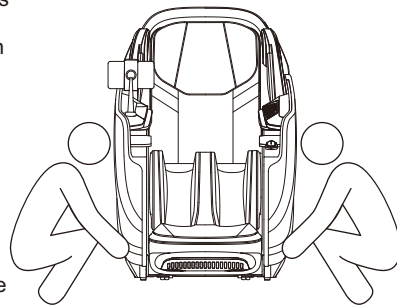

Place Massage Chair

Move method

Use the rear casters to move the massage chair. Move the chair by tilting it down and backward about 45° as shown in the diagram.
NOTE: Excessive force to tilt will cause the chair to tip over completely and product damage.



Caution

1. Before moving, please shut down the machine properly to reset the whole machine, and then cut off the power.
2. Please keep the chair vacant when moving. (People, pets or clutter will not be able to stay on the chair.)
3. When moving, do not cross a drop barrier higher than 2mm or a gap greater than 5mm.
4. When using casters to move this product, single continuous movement is not supported; if the distance exceeds 50 meters, please make this product move slowly and evenly. e the product slowly and uniformly.

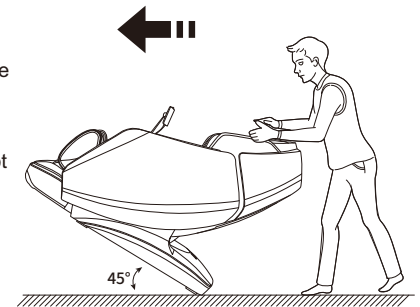

How to disassemble and use headrest cushion and backrest cushion

Using a headrest cushion can reduce the intensity of kneading massage on the neck and shoulders, and you can decide whether to use a headrest cushion according to your needs (recommended to use a headrest cushion). The backrest cushion and the backrest are connected by a zipper (1), and the headrest cushion and the backrest cushion are connected by a zipper (2).



Caution

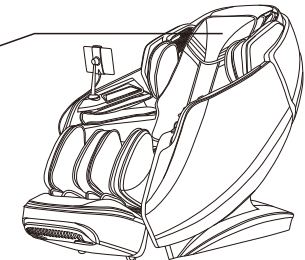
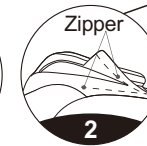

Before Use

Check around

Make sure that there are no people, pets and other objects around the unit.

! Caution

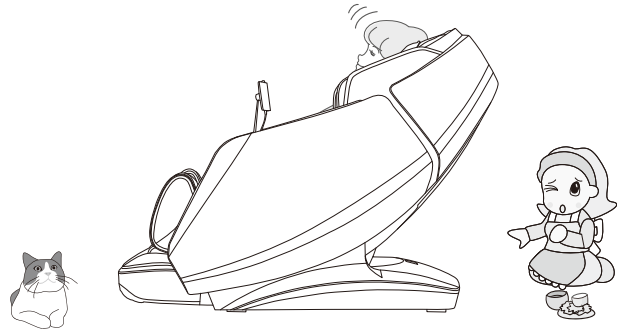

Make sure there are no foreign objects in the gaps of the machine

Before massaging, make sure that no foreign objects are caught in the legs, feet, etc.

Under no circumstances allow hands, feet, and head to penetrate into the area between the lower leg mechanism and main body, or the area between the armrest and the capsule.

Under no circumstances should hands, feet, or head sink under the fabric or leather covering of the massage area.

! Caution

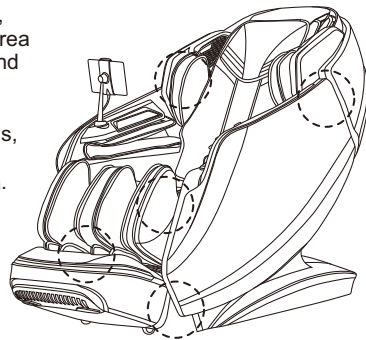

Before Use

Turn on the power

! Caution

Plug in power cord

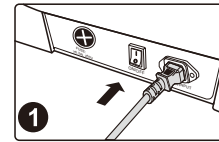

Schematic diagram of power on

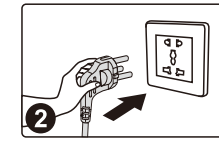

Turn on the power switch ("I" position)

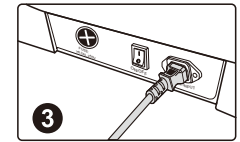

! Warn

- Please check the power cord and plug for damage before use.
- Please supply power to this product in accordance with the working power requirements of this product's calibration.
- It is strictly forbidden to use a power supply other than the nominal power supply of this product.
- It is strictly forbidden to connect various power conversion devices without authorization to supply power to this product.

Product Structure

Description of Components

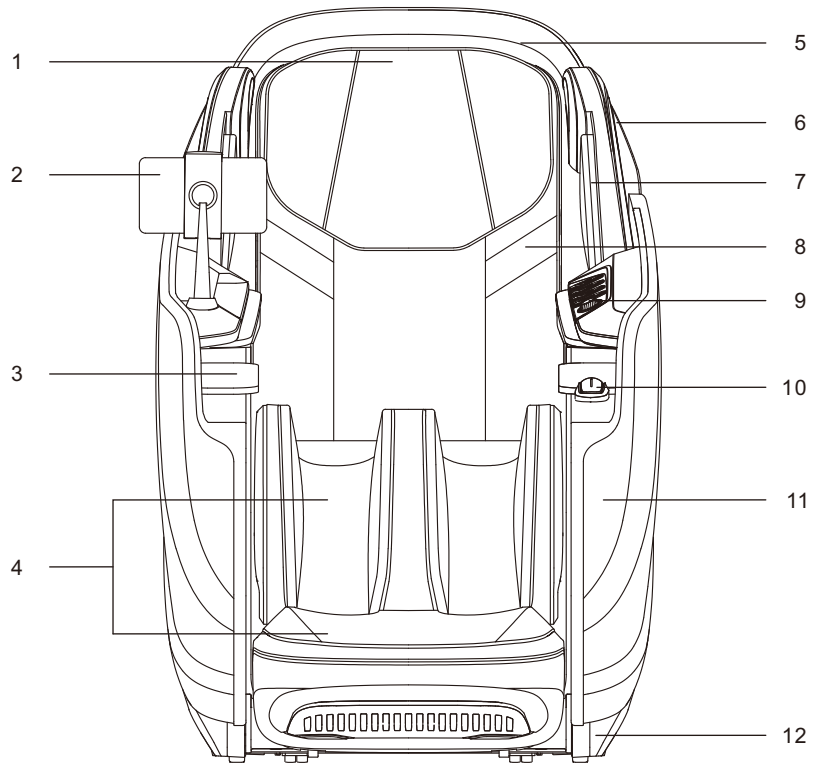

- 1.Head cushion
- 2.Remote controller
- 3.Arm air pressure
- 4.Leg massage unit
- 5.Ambient lighting
- 6.Space capsule

- 7.Shoulder air pressure
- 8.Shawl backrest cushion
- 9.Armrest Shortcut Keys
- 10.Health sensor
- 11.Armrest
- 12.Side panel

Product Structure

Schematic view of functional distribution

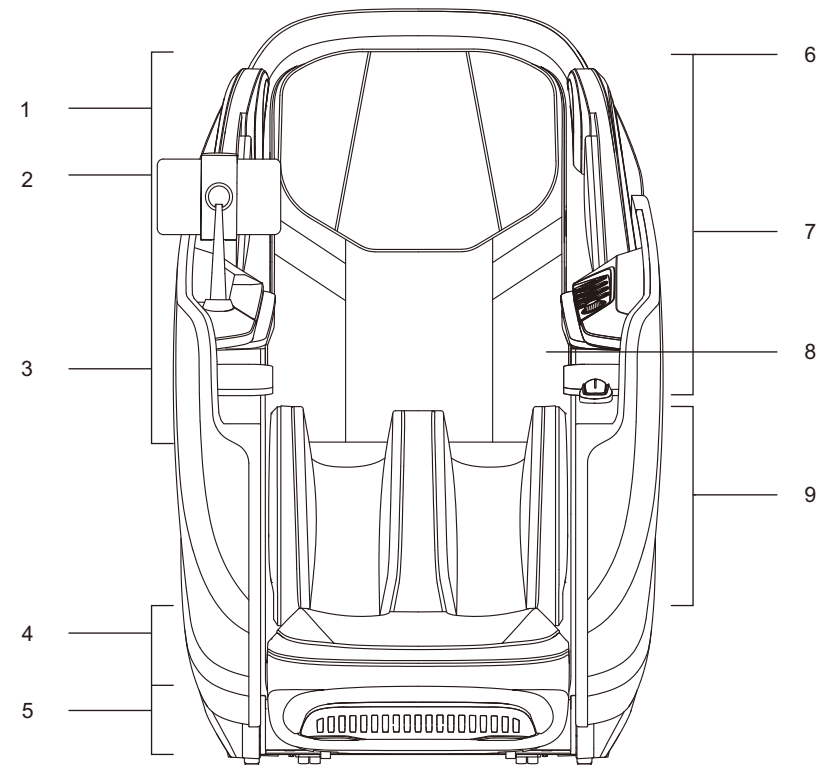

1.Shoulder

- Airbag massage

2.Arm

- Remote controller rest
- Mobile phone placement rest
- USB charging socket
- Wireless charger
- Built-in voice control microphone

3.Hand

- Airbag massage

4.Leg

- Airbag massage

5.Sole

- Roller massage

6.Both sides of the head

- Audio music playback

7.Head & neck to seat part

- Manipulator massage

8.Waist and shoulder

- Heating function

9.Leg

- Airbag massage
- Kneading massage

Product Structure

How to use the shawl

- It is provided with a unique shawl assembly, with innovative heating functions on the shoulder, back, waist and abdomen and heating with graphene. Users can place the shawl at different massage positions according to massage requirements. When the shawl assembly is placed at the shoulder position, it will heat the acupoints such as Bingfeng, Tianzong, Yunmen and Qihu around the shoulder and clavicle by graphene heating, effectively relieving symptoms such as scapulohumeral periarthritis and cough, and removing cold and moisture from shoulder joints.
- When the shawl assembly is placed on the abdomen and back (dual-purpose), through graphene heating, it plays the role of dispelling cold and relieving pain, warming channels and removing blood stasis in the back and abdomen, distributing Qi and blood of the back and abdomen meridian, alleviating the symptoms such as irregular menstruation and dysmenorrhea for women, relieving low back pain and kidney discomfort, warming intestines and stomach and clearing intestinal cold, with a good effect on some people with deficiency of qi and deficiency of spleen and stomach.

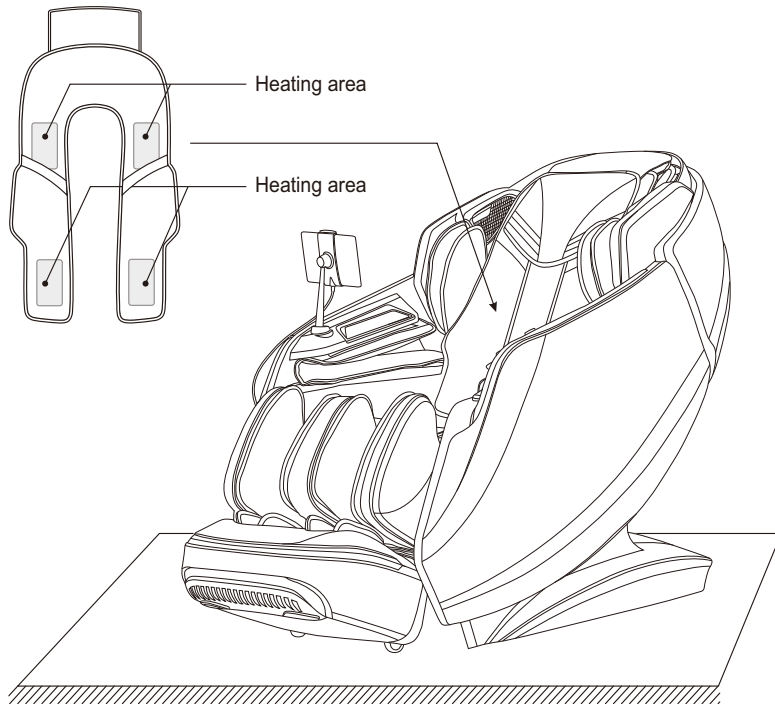

Product Structure

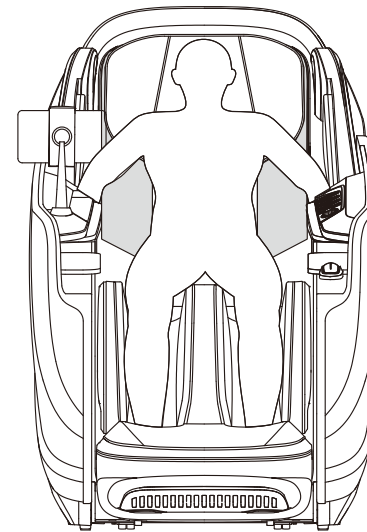

Schematic diagram
of use on back and waist

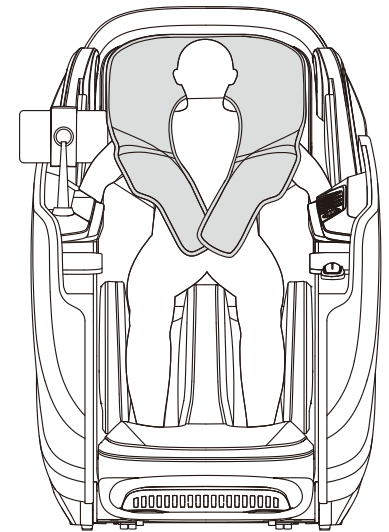

Schematic diagram of use
on shoulder and abdomen

Product Structure

I.Remote controller keys instruction

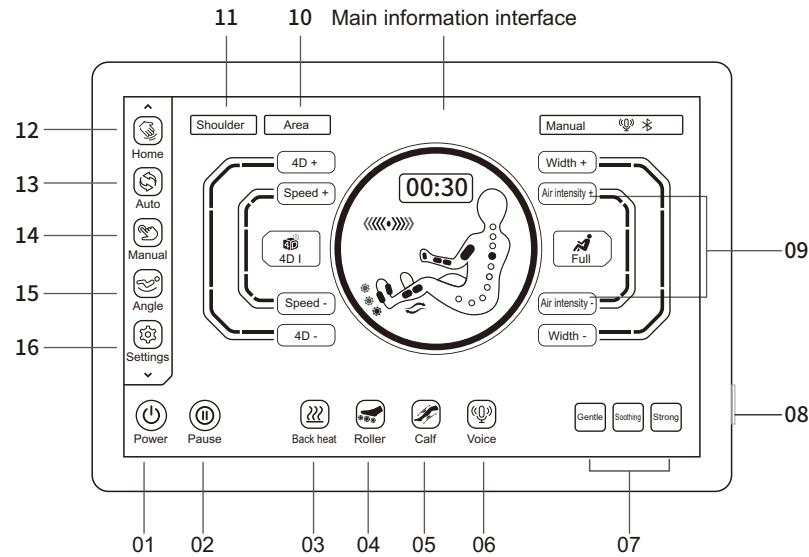

- 01.On/off touch key: Enable or disable the massage chair function.
- 02.Pause key: Pause the massage or exit from pause massage.
- 03.Back heating key: Enable or disable the back heating function.
- 04.Sole roller key: Enable or disable the sole roller function.
- 05.Calf kneading key: Enable or disable the calf kneading function.
- 06.Voice control key: Enable or disable the voice control function.
- 07.Intensity selection key: Select one from different automatic massage intensities.
- 08.Button on/ff key: Turn on or off the massage chair.
- 09.Air intensity key: The function of regulating air intensity massage.
- 10.Massage area key: The function of selecting massage position.
- 11.Shoulder position adjustment key: Regulate shoulder position and confirm massage criterion.
- 12.Current status key: Enter to view current massage chair status.
- 13.Automatic function menu key: Enter to select automatic massage program.
- 14.Remote function menu key: Enter to remotely set the massage function.
- 15.Seat adjustment menu key: Enter the sitting posture adjustment interface to select sitting posture angle.
- 16.Setting menu key: Enter the setting menu interface.

Product Structure

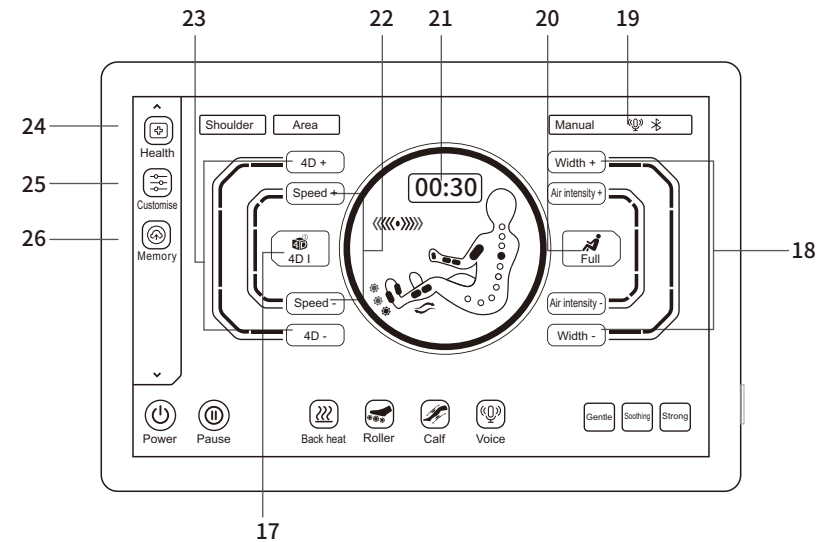

- 17.Massage technique selection key: Select the massage technique.
- 18.Massage width key: Adjust the massage width.
- 19.Status display bar key: Display the massage program status information.
- 20.Air massage selection key: Select air position.
- 21.Time adjustment menu key: Adjust the massage time.
- 22.Massage speed key: Adjust the massage speed.
- 23.4D intensity key: Adjust 4D intensity.
- 24.Health detection menu key: Enter the health detection interface.
- 25.Custom menu key: Enter the custom interface.
- 26.Storage menu key: Enter the storage interface.

Product Structure

II. Description of armrest shortcut keys

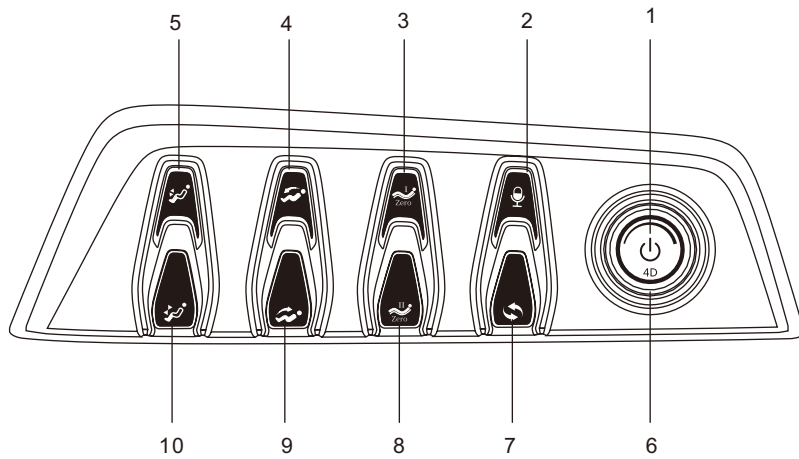

1. On/off key: Turn on or off the massage chair.
2. Voice key: Long press to turn on or off the voice assistant function. Short press to wake up the voice assistant function.
3. Zero-gravity key I: For zero-gravity angle setting, press this key to adjust the massage chair seat-down angle to zero-gravity key I position.
4. Linkage rising key: Adjust the massage chair angle upward.
5. Leg unit extension key: Leg unit stretching.
6. 4D intensity knob key: Turn the knob clockwise to enhance the 4D intensity. Turn the knob counterclockwise to weaken the 4D intensity.
7. Automatic mode key: Automatic massage program switching.
8. Zero-gravity key II: For zero-gravity angle setting, press this key to adjust the massage chair seat-down angle to zero-gravity key II position.
9. Linkage lowering key: Adjust the massage chair angle downward.
10. Leg unit shrinkage key: Leg unit shortening.

Operation Instructions

III. Start massage

1. Press the remote controller side button on/off key or long press the armrest on/off key

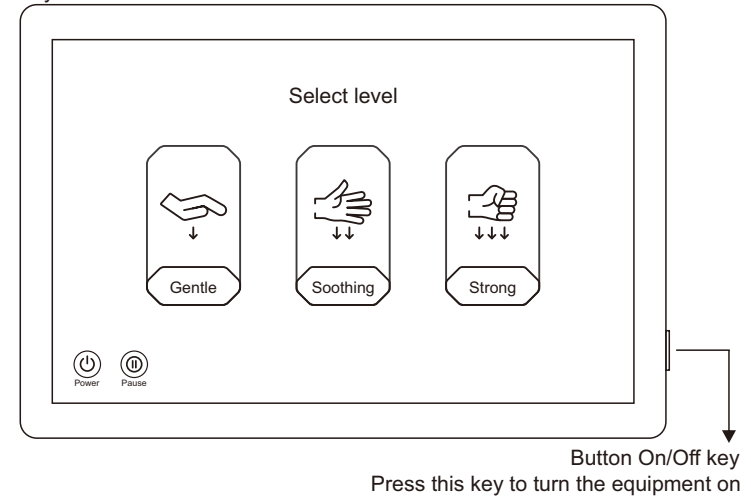

2. After the system is started, select the massage intensity by clicking on any one of the Gentle , Comfort or Strong keys on the remote controller to turn on the massage chair and enter the lying state. If it is not selected within 5 minutes, the massage chair will turn off automatically.

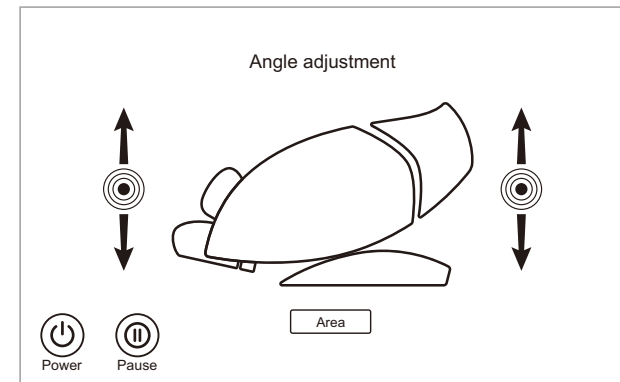

3. For automatic angular adjustment, select the automatic program, then the massage chair will be automatically adjusted to zero-gravity angle, and wait until its adjustment is completed. To skip a step, press the skip key to go directly to the next step.

Operation Instructions

4.Wait until body shape detection is completed, or you can press the skip key **Skip** to skip detection and start massage directly.

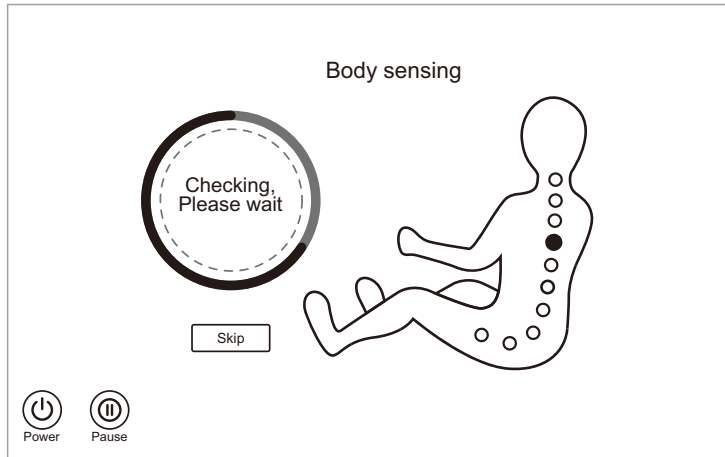

For fine adjustment of shoulder position, after body shape detection, the remote controller or a voice prompt will remind the user of fine adjustment of shoulder position. If the massage roller stops at the shoulder position, directly press the OK key **OK** to start massage. If not, use the Up key **▲** and Down key **▼** to adjust the massage roller to the shoulder position, and then press the OK key **OK** to start the massage. If no operation is made within 20s, directly default the current massage roller position for the shoulder position and start massage.

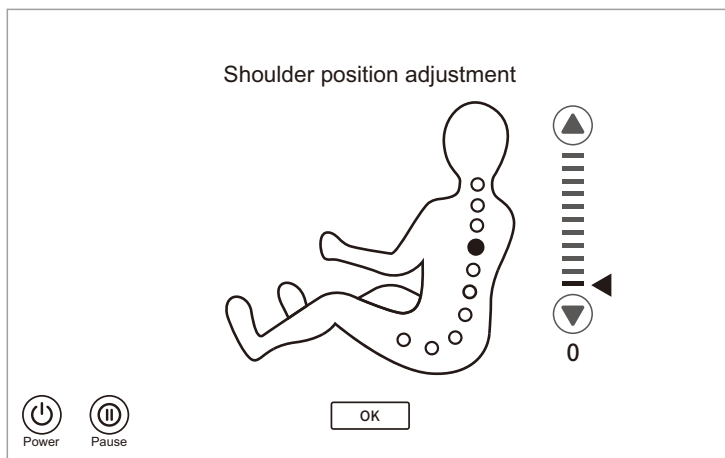

Operation Instructions

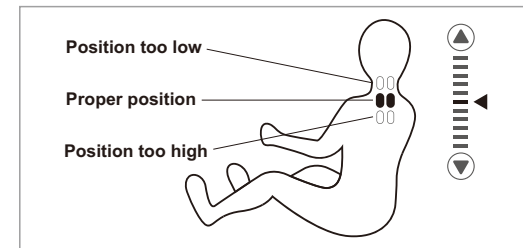

IV.Pause function (please use this function after the equipment is turned on)

After the massage chair is turned on, press the pause key **⏸** to enter the pause state, then all massage functions will be suspended, and press the pause key **▶** again to resume the previous massage state.

Note: In the pause state, all functions do not work except shutdown.

V.Automatic program (please use this function after the equipment is turned on)

Automatic program selection

(1)Select the Automatic key **🔄** in the left menu bar to enter the automatic selection interface.

(2)In the automatic program selection interface, there are 20 automatic program options available: Total Relax, Chinese Massage, Relieve Muscle, Body Balance, Thai Massage, Full-body Stretch, Neck & Shoulder Care, Hips&legs Fit, Spine Traction, Leg&foot Relieve, Superior Enjoyable, President Cosy, Keep Fit, Office Regimen, Health Recharge, Energy Boost, Lunch Break, Back Spa, Sport Recovery, Sweet Dream.

(3)Select the desired automatic massage program and click to start massage.

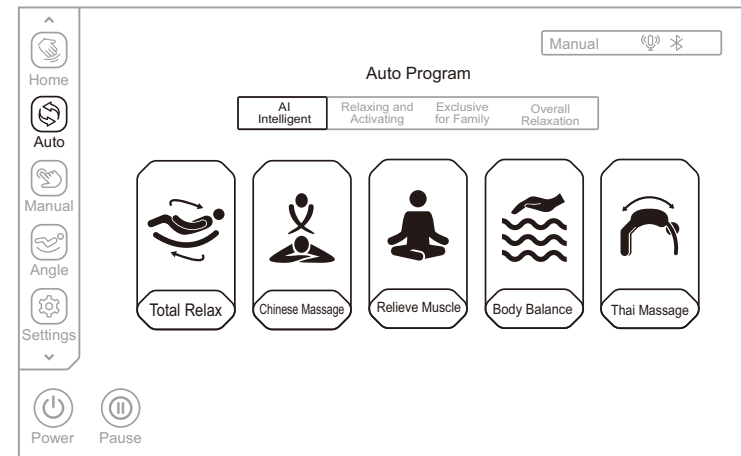

Schematic diagram of automatic massage program selection

Operation Instructions

Massage scenes(AI Intelligent)	
Function	Description
Total Relax	With the aid of flexible guide rails, let the body posture angle closer to lying flat; with the effective anti-arch stretching of 3D movement to the back, achieve zero pressure stretching, effectively relieve lumbar muscle pain, and eliminate fatigue, thus to get a better massage experience, relieve the stress on the body and mind.
Chinese Massage	By means of Traditional Chinese medicine massage technique mainly, apply 3D massage on the back and waist so as to promote the blood circulation of the back and waist, soothe the meridians and relieve the blockage of the back and waist through massage. It is suitable for people with back and waist pain, and lumbar muscle strain. Massage intensity is gentle.
Relieve Muscle	Apply deep pressure on the neck, back and waist, buttocks, and legs by means of kneading, patting, finger pressing techniques mainly to relieve the fatigue on body, allowing the body to better relax.
Body Balance	Apply full air massage mainly, with the use of airbags for cross circulation of kneading and pressure, so as to promote blood circulation, alleviate pain in various body parts, and deeply relieve muscle fatigue. (Remarks: full air massage mainly, with frequent air massage action)
Thai Massage	Mainly use calf and backrest electric push rod to clamp legs, hands and shoulders with the aid of air massage, and then apply stretching massage, while the movement holds against the back and waist for 3D medical massage, so that the body is in the Thai stretching state. It is suitable for people under high stress to improve their head-down on chest and humpback. Massage intensity is strong.

Operation Instructions

Massage scenes(Relaxing and Activating)	
Function	Description
Full-body Stretch	By means of kneading, patting, finger pressing and medical massage techniques mainly, clamp the legs, hands and shoulders with the aid of air massage, and then apply stretching massage to soothe the meridians, promote blood circulation, relieve blockages in the body.
Neck & Shoulder Care	Massage the neck and shoulders by means of kneading and stretching techniques mainly, and also the upper back by medical massage, and then press the Jianjing acupoint to relieve cervical spondylosis and achieve the effect of relaxing the muscles of the neck and shoulders. Massage intensity is gentle, suitable for people working in office and suffering from cervical fatigue.
Hips&legs Fit	Massage buttocks by kneading and medical massage mainly, and then through patting and kneading, deeply massage buttocks and perineum, to relax the hip muscles and lift the hip, which is suitable for women massage, and also for men for maintenance of prostate.
Spine Traction	Massage the waist by means of kneading, patting and medical massage mainly, while the movement holds against the back and waist for 3D medical massage, so as to relieve lumbar spine pain; combined with the thermostatic heat configuration around the waist, maintain a comfortable temperature to bring warm massage experience; with gentle and moderate massage intensity and comfortable temperature, bring warm massage experience.
Leg&foot Relieve	Massage the shoulders and waist by means of kneading, patting, kneading and patting mainly, apply air massage on the legs and feet for squeezing massage, allowing more soothing leg and foot massage, suitable for sedentary people with low stress on the legs and feet, not only relieving the cervical spine, lumbar spine pain of sedentary people, but also soothing the legs and feet. Massage intensity is gentle.

Operation Instructions

Massage scenes(Exclusive for Family)	
Function	Description
President Cosy	Massage the shoulders, neck, back and waist by means of kneading, patting, kneading and patting mainly, to relieve fatigue, promote blood circulation, and release stress by such deep massage. It is suitable for men, and the massage intensity is moderate.
Keep Fit	Massage the shoulders, neck, waist and hips by means of kneading and finger pressing techniques, through the massage on the whole body, to relax the body and mind, and enjoy the queen-level treatment. It is suitable for women, and the massage intensity is gentle.
Superior Enjoyable	Apply air massage on the whole body, with the foot roller and calf kneading massage. Calf stretching function is canceled, suitable for the elderly and people suffering stress on back. The massage intensity is gentle.
Office Regimen	Massage the shoulders, neck and waist by means of kneading, patting, kneading and patting techniques mainly, to relieve shoulder and neck pain, improve lumbar muscle soreness and maintain lumbar spine through such deep massage. It is suitable for office white-collar and sedentary people, and the massage intensity is moderate.
Health Recharge	Deeply massage the whole body by means of kneading, patting and finger pressing techniques, to promote blood circulation throughout the body and prevent blood clots. It is suitable for people who live at home for a long time and do not like to go out, and the massage intensity is moderately gentle.

Operation Instructions

Massage scenes(Overall Relaxation)	
Function	Description
Energy Boost	Massage the waist, shoulders and neck by means of kneading, patting, kneading and patting techniques, to awaken the body's vital energy, stimulate physical energy through such deep massage of the whole body with the massage intensity being heavy, which is suitable for people with strong stress, such as athletes, for stimulating the potential before a race.
Lunch Break	Massage the back and waist by means of kneading and patting techniques, and press the Shenyu acupoint, to improve the quality of lunch break, so that the user is more energetic in afternoon work. It is suitable for office workers, and the massage intensity is gentle.
Back Spa	Deeply massage the whole body by pressing related acupoints by means of kneading, patting, finger pressing and other massage techniques, to let the stimulation fully reach the deep layer of muscle tissue, feel warm locally combined with the function of hot compress, and regulate the Qi and blood in a bid to achieve the effect of warmth and damp expelling. (Note: the whole body massage together with hot compress)
Sweet Dream	Massage the shoulders, neck, back and waist by means of kneading and medical massage techniques, and press the acupoints of Fengchi and Shenyu, to improve the sleep quality and help sleep. It is suitable for people suffering from poor sleep, and the massage intensity is gentle.
Sweet Dream	Massage the shoulders, neck, back and waist by means of kneading and medical massage techniques, and press the acupoints of Fengchi and Shenyu, to improve the sleep quality and help sleep. It is suitable for people suffering from poor sleep, and the massage intensity is gentle.

Operation Instructions

VI.remote program (please use this function after the equipment is turned on)



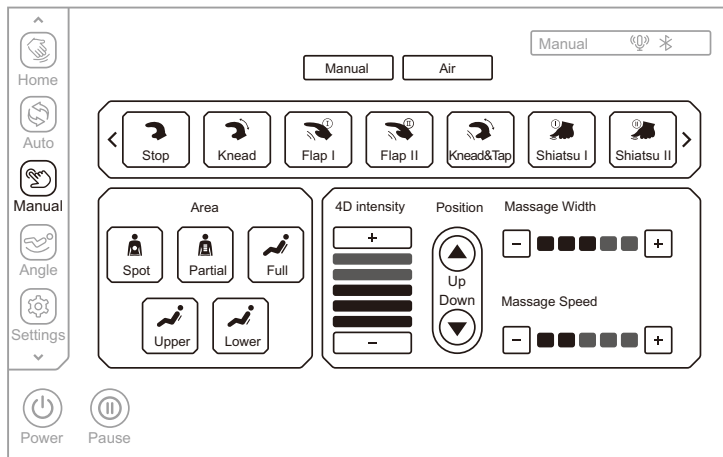

Remote program selection

Select the remote key  in the left menu bar and click to enter the remote menu to select massage technique, massage area, 4D intensity, massage hand adjustment, massage width, massage speed, air massage, air intensity and other massage functions.







1. In the massage technique menu, a total of 11 options are available, including kneading, patting I, patting II, kneading and patting, finger pressing I, finger pressing II, shoulder grasp, 4DI, 4DII, 4DIII and 4DIV. (Note: Click the "leftward arrow <" and rightward arrow >" button in the remote adjustment menu to scroll left and right to display more massage techniques).



Remote program - Schematic diagram of technique selection

Function	Massage roller adjustment
4D I 	Speed and strength.
4D II 	Speed and strength.
4DIII 	Speed, width and strength.
4DIV 	Speed, width and strength.

Operation Instructions

Function	Massage roller adjustment
Stop	Press this key to massage without any technique.
Knead 	The speed and strength can be adjusted.
Flap I 	The speed, width and strength can be adjusted.
Flap II 	The speed, width and strength can be adjusted.
Knead&Tap 	The speed and strength can be adjusted.
Shiatsu I 	The speed, width and strength can be adjusted.
Shiatsu II 	The speed, width and strength can be adjusted.
Grasp 	The speed and strength can be adjusted.

-Adjustable speed in five gears
-Adjustable width in five gears
-Adjustable intensity in five gears

Note: You can also click the massage technique key  in the "Current Status" interface to select the corresponding massage technique in the pop-up menu for massage (this function is a shortcut for switching massage techniques in the current status page of the remote program - technique adjustment).

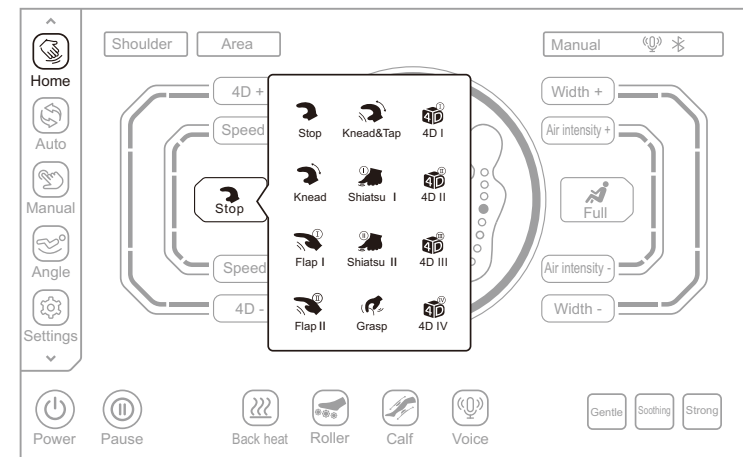

Current Status - Schematic diagram of technique selection

Operation Instructions

2.The massage area menu has five options: Spot, Partial, Full, Upper and Lower. Select the corresponding massage area for massage.

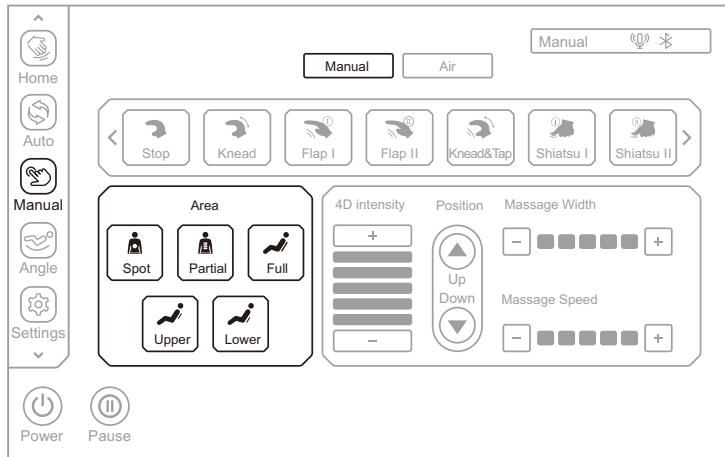

Remote program - Schematic diagram of massage area selection

Key	Description
	Fixed-point massage at fixed-point position.
	Small-scope local massage back and forth.
	Full back massage back and forth.
	Upper back massage back and forth.
	Lower back massage back and forth.

Note: You can also click the massage area key **Area** in the "Current Status " interface to select the corresponding massage area in the pop-up menu for massage (this function is a shortcut for switching massage areas in the current status page of the remote program - massage area).

Operation Instructions

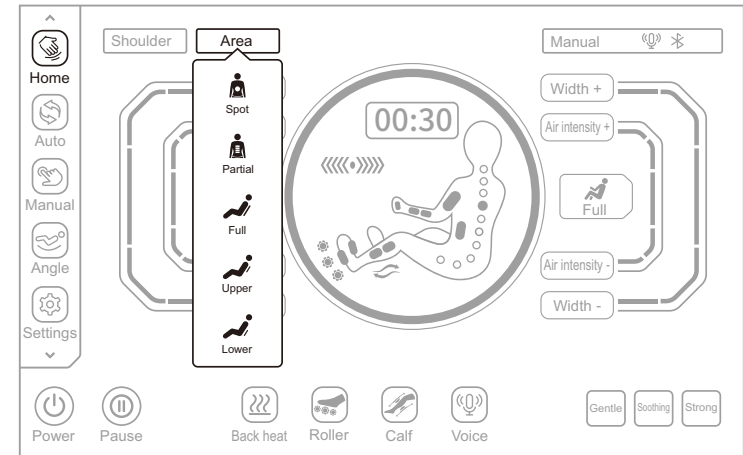

Current Status - Schematic diagram of massage area selection

3.You can adjust 4D intensity in the 4D intensity menu. There are 1~5 gears available for adjustment with 1 being the weakest and 5 being the strongest. The stronger the 4D intensity, the higher the massage roller ejection and the greater the massage strength. Select plus key **+** or minus key **-** to reduce the 4D intensity.

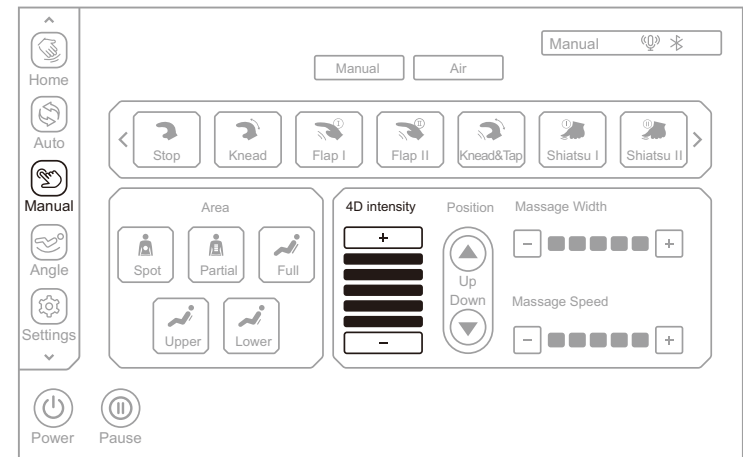

Remote program - Schematic diagram of 4D intensity

Operation Instructions



Key	Description
+	Press this key to increase 4D intensity which is adjustable from 1 to 5.
-	Press this key to decrease 4D intensity which is adjustable from 1 to 5.

Note: You can also select the 4D intensity + key **4D +** or 4D intensity - key **4D -** in the "Current Status" interface to adjust the 4D intensity. (This function is a shortcut to the 4D intensity in the current status page of the remote program-4D intensity).

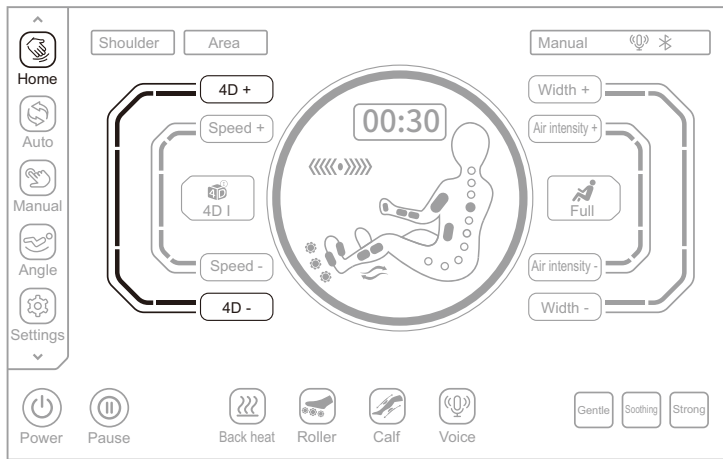

Current Status - remote program-4D intensity

Key	Description
4D +	Press this key to increase 4D intensity which is adjustable from 1 to 5.
4D -	Press this key to decrease 4D intensity which is adjustable from 1 to 5.

Operation Instructions

4. For message hand adjustment, select the Up arrow or the Down arrow down to upwards or downwards fine-adjust the message hand position.

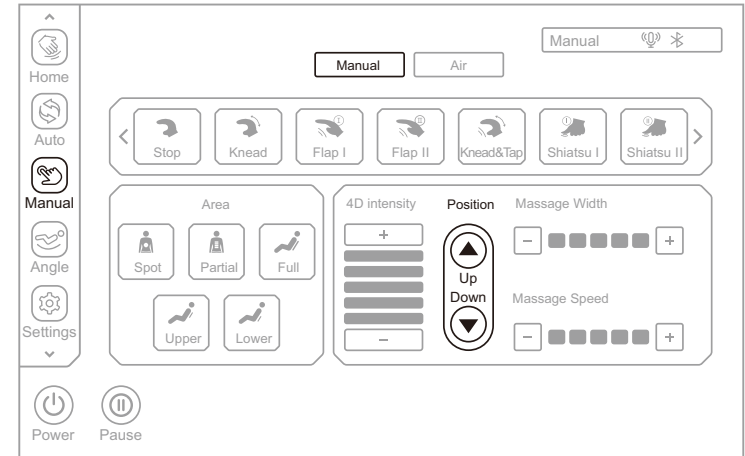

Remote program - Schematic diagram of message hand adjustment

5. For message width, as shown in the figure below, select the message width to adjust.

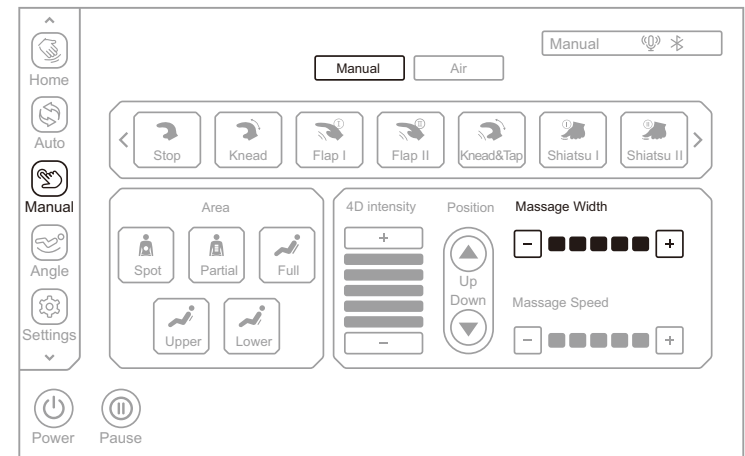

Remote program - Schematic diagram of message width

Operation Instructions

- (1)The width can be adjusted only when the user enters the remote mode in selecting massage technique or massage area.
- (2)The massage width is available from 1 to 5 gears, with 1 being the narrowest and 5 being the widest. Please use the following massage techniques: PattingI, Patting II, Finger PressingI, Finger Pressing II, 4D III and 4D IV.

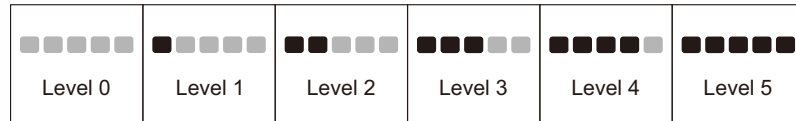

Key	Description
+	Press this key to increase massage width which is adjustable from 1 to 5.
-	Press this key to decrease massage width which is adjustable from 1 to 5.

Note: You can also select the massage width + key **Width +** or massage width - key **Width -** in the "Current Status" interface to adjust the massage width.

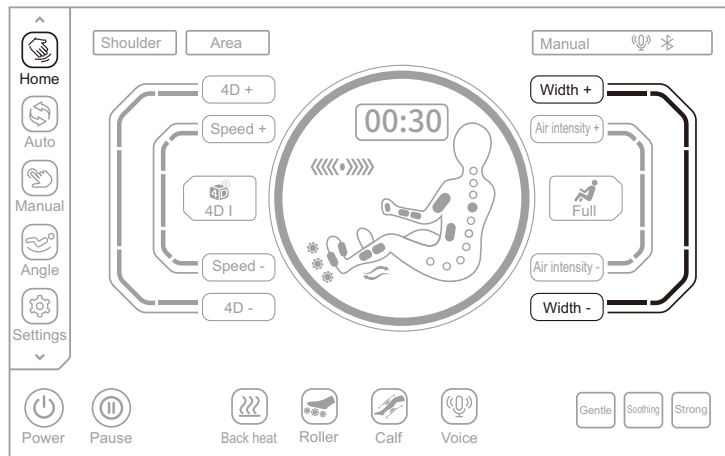

Current Status - Schematic diagram of massage width



Operation Instructions

Key	Description
Width +	Press this key to increase massage width which is adjustable from 1 to 5.
Width -	Press this key to decrease massage width which is adjustable from 1 to 5.

- 6.For massage speed, as shown in the figure below, select the massage speed to adjust.

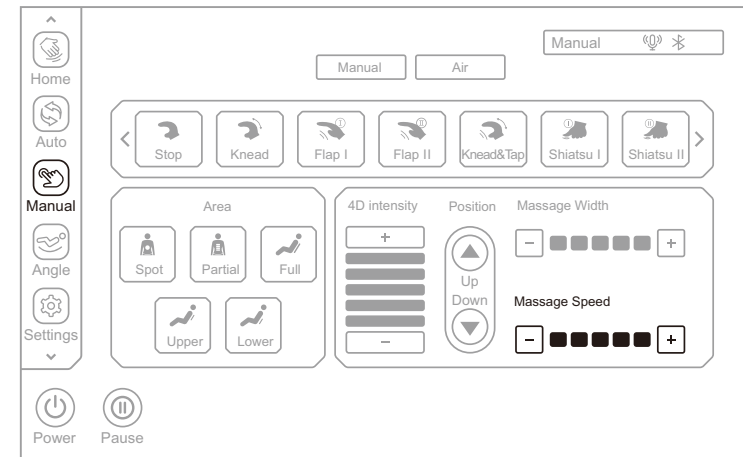

Remote program - Schematic diagram of massage speed

- (1)The speed can be adjusted only when the user enters the remote mode in selecting massage technique or massage position.
- (2)The massage speed is available from 1 to 5 gears, with 1 being the fastest and 5 being the slowest. The speed cannot be adjusted when the massage technique stops.

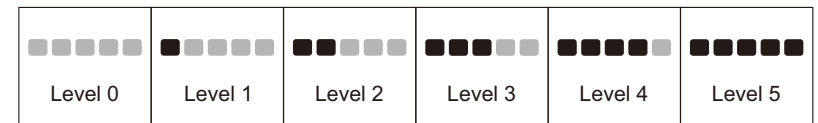

Key	Description
+	Press this key to increase massage speed which is adjustable from 1 to 5.
-	Press this key to decrease massage speed which is adjustable from 1 to 5.

Operation Instructions

Note: You can also select the massage speed + key **Speed +** or massage speed - key **Speed -** in the "Current Status"  interface to adjust the massage speed.

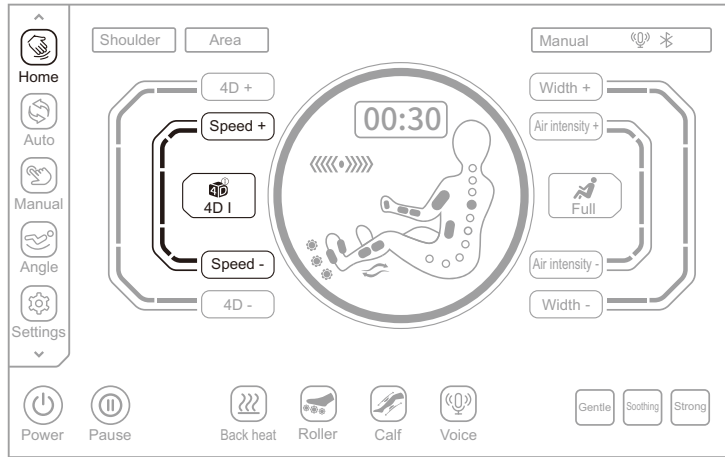

Current Status - Schematic diagram of massage speed

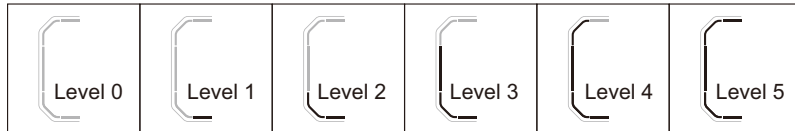



Key	Description
Speed +	Press this key to increase massage speed which is adjustable from 1 to 5.
Speed -	Press this key to decrease massage speed which is adjustable from 1 to 5.

Operation Instructions

7. For air massage, as shown in the figure below, enter the air massage menu to select the air mode. The air modes include upper body, lower body, and whole body air massage. The air function will be disabled when all above modes are off.



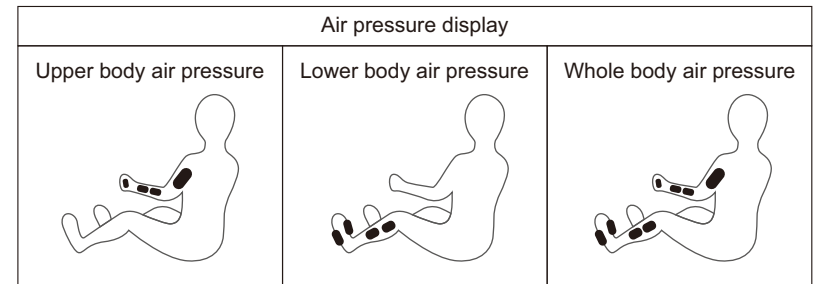

Remote program-Schematic diagram of air massage

Key	Description
	Press this key to enable or disable the whole body air massage function.
	Press this key to enable or disable the upper body air massage function.
	Press this key to enable or disable the lower body air massage function.



Operation Instructions

Note: You press also air massage key  in the "Current Status  " interface, and select corresponding air mode in the pop-up menu. (This function is a shortcut to the air massage in the current status interface of the remote function - air massage.)

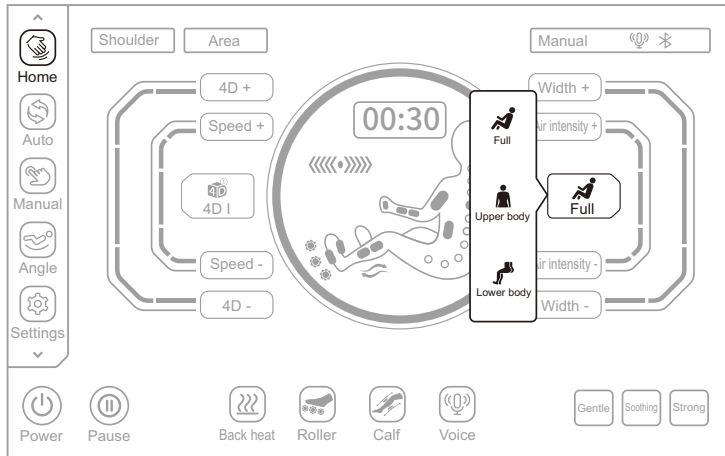



Current status - Schematic diagram of air massage

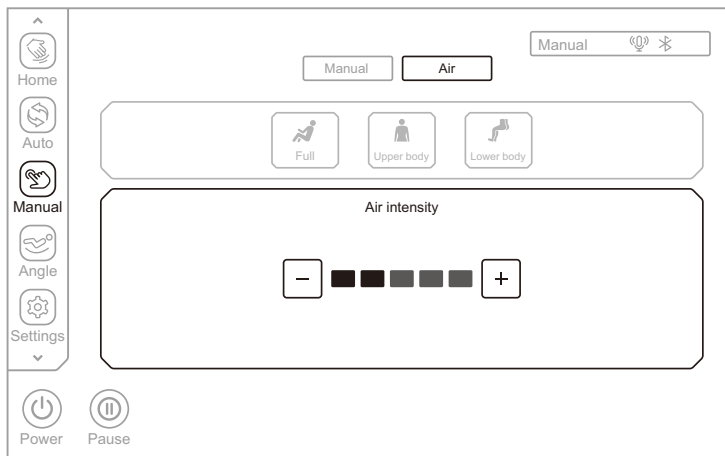

8. For air intensity adjustment, the air function shall be turned on so as to adjust the air intensity, with a total of five adjustable levels, with 1 being the weakest and 5 being the strongest.



Operation Instructions



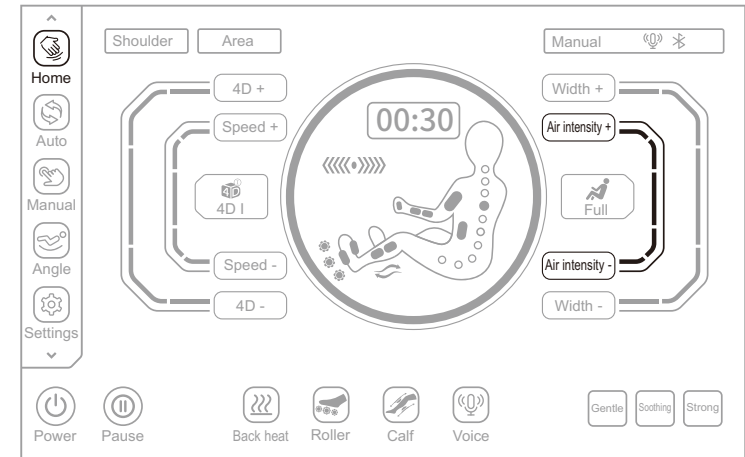

Key	Description
	Press this key to increase the air intensity which is adjustable from 1 to 5.
	Press this key to decrease the air intensity which is adjustable from 1 to 5.

Note: You can also adjust the air intensity by selecting the air intensity+ key  air intensity- key  in the "Current Status  " interface with the adjustable intensity in five levels.

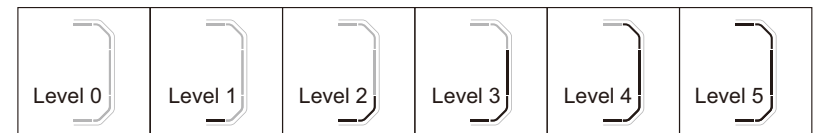

Current status - Schematic diagram of air intensity



Key	Description
	Press this key to increase the air intensity which is adjustable from 1 to 5.
	Press this key to decrease the air intensity which is adjustable from 1 to 5.

Operation Instructions

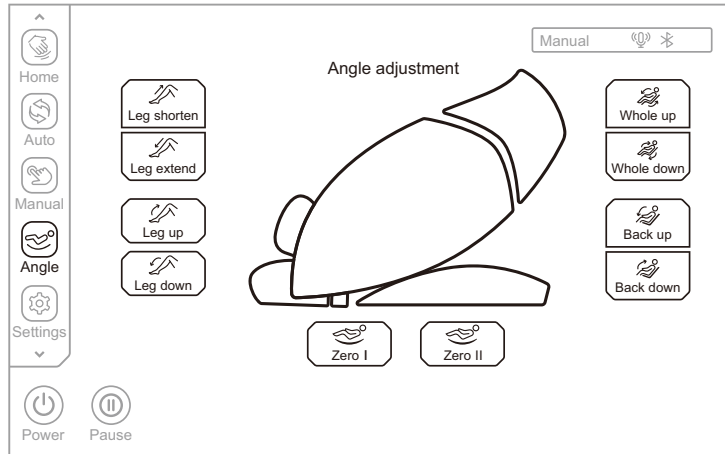

VII. Seat adjustment

Click the "Seat Adjustment  " button in the menu bar on the left side of the display to enter the Seat Adjustment interface, with massage functions including leg unit extension/shortening, leg unit Up/Down, linkage Up/Down, zero-gravity I and II .





Schematic diagram of sitting posture adjustment



1.Zero-gravity adjustment

Key	Description
 Zero I	Zero-gravity 1 key: automatically adjust the position of leg unit and backrest unit to zero-gravity 1 position.
 Zero II	Zero-gravity II key: automatically adjust the position of leg unit and backrest unit to zero-gravity II position.



2. Seat-down angular adjustment

Key	Description
 Leg up	Leg unit Up key: press and hold this key to slowly raise the leg unit, and release it to stop rising; after the leg unit rising action is completed, the leg unit will automatically detect the foot length.
 Leg down	Leg unit Down key: press and hold this key to slowly lower the leg unit, and release it to stop lowering; after the leg unit lowering action is completed, the leg unit will automatically detect the foot length.



Operation Instructions

Key	Description
 Whole up	Linkage Up key: press and hold this key to slowly raise the backrest unit while slowly lowering the leg unit, and release it to stop raising the backrest unit or lowering the leg unit; after the linkage rising action is completed, the leg unit will automatically detect the body height.
 Whole down	Linkage Down key: press and hold this key to slowly lower the backrest unit while slowly raising the leg unit, and release it to stop lowering the backrest unit or raising the leg unit; after the linkage lowering action is completed, the leg unit will automatically detect the body height.

3.Backrest unit angular adjustment

Key	Description
 Back up	Backrest unit Up key: press and hold this key to slowly raise the backrest unit and release it to stop rising.
 Back down	Backrest unit Down key: press and hold this key to slowly lower the backrest unit and release it to stop lowering.

4.Leg unit extension/shortening adjustment

Key	Description
 Leg shorten	Leg unit shortening key: remotely adjust shortening of the leg unit; press and hold this key to move the leg unit up slowly and stop when released.
 Leg extend	Leg unit extension key: remotely adjust extension of the leg unit; press and hold this key to move the leg unit down slowly and stop when released.

Operation Instructions

VIII. Setting (please use this function after the equipment is turned on)

Click the "Setting  " button in the menu bar on the left side of the display to enter the setting interface, where you can view the product model, software version number, product serial number, and firmware version number. In the interface, functions such as Bluetooth, voice control, voice broadcast, language selection, volume, and ambient lighting control are available for setting.

1.Product model, software version, product serial number, and firmware version show the information of current device.

2. Bluetooth

Click Bluetooth switch to enable or disable the Bluetooth function. After pairing and connecting the sound source device with Bluetooth function (such as mobile phone, MID tablet, etc.) with the Bluetooth module of the massage chair, the music played by the sound source device can be wirelessly transmitted to the sound system of the massage chair through Bluetooth for music playing.

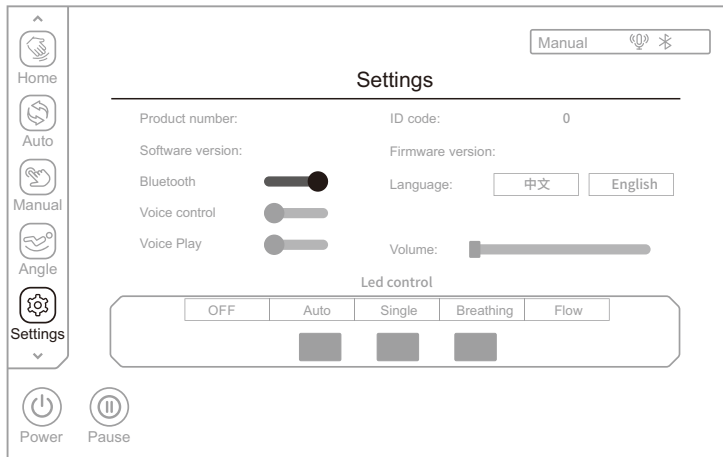

Schematic diagram of Setting

Operation Instructions

3. Language selection

The language is English by default. Chinese is optional.

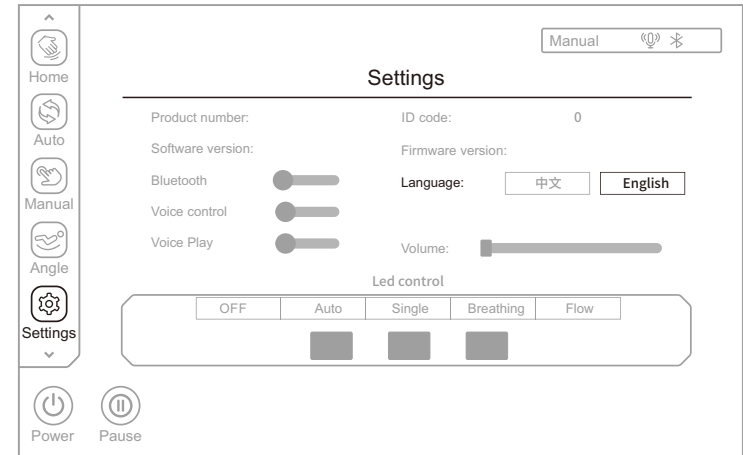

4. Voice Control

Click Voice Control switch to enable or disable the Voice Control function. After enabling the voice function, you can control the massage chair by voice according to the content of the voice entry.

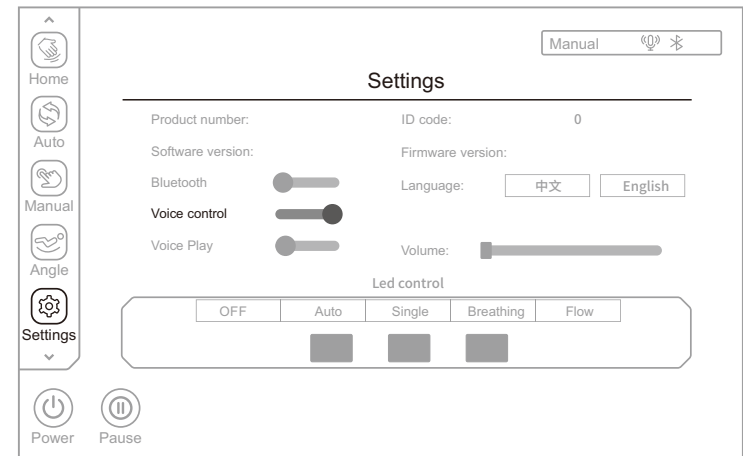

Operation Instructions

(1) Say "Hi Alice" or "Hey Alice" near the speaker to wake up the voice assistant, or press the voice key  in the right armrest shortcut to wake up the voice assistant. If the voice assistant answers "I am here", it means it has been woken up.
 (2) After waking up the voice assistant, please say the command within 6s to realize the function control of the massage chair. You can continue to say a command after the voice assistant responds to the previous command, but the interval between two adjacent commands shall be no more than 6s, or you need to wake up the voice assistant again. The detailed list of voice commands is as follows:

Voice Control Entry		
Entry: "Hi Alice" or "Hey Alice". Answer: I am here.		
No.	Voice control entry	Answer entry
1	Massage on	Answer: Ok, Massage on
2	Massage close	Answer: Ok, Massage close
3	Total Relax	Answer: Ok, Total Relax
4	Energy Boost	Answer: Ok, Energy Boost
5	Sweet Dream	Answer: Ok, Sweet Dream
6	Neck & Shoulder Care	Answer: Ok, Neck & Shoulder Care
7	Lunch Break	Answer: Ok, Lunch Break
8	Thai Massage	Answer: Ok, Thai Massage
9	Open the air pressure	Answer: Ok, Open the air pressure
10	Close the air pressure	Answer: Ok, Close the air pressure
11	Up the seat position	Answer: Ok, Up the seat position
12	Down the seat position	Answer: Ok, Down the seat position
13	Change the other mode	Answer: Ok, Change the other mode
14	Go little down	Answer: Ok, Go little down
15	Go little up	Answer: Ok, Go little up

Note: commands 14 and 15 can only be used after command 13.

Operation Instructions

5. Voice Broadcast

After clicking the "Voice Broadcast" switch and enabling the Voice Broadcast function, the user will be reminded how to use the massage chair correctly in use of the massage chair to help a new user become familiar with the massage functions faster.

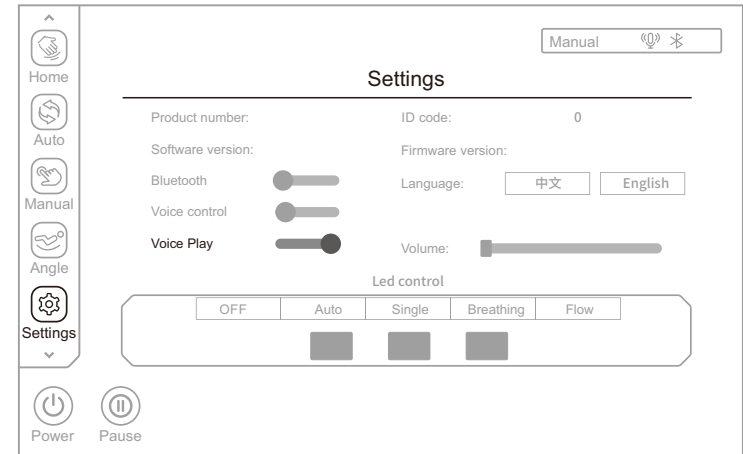

6. Volume

Select the volume slider and slide it left or right to adjust the volume level with 10 being the maximum.

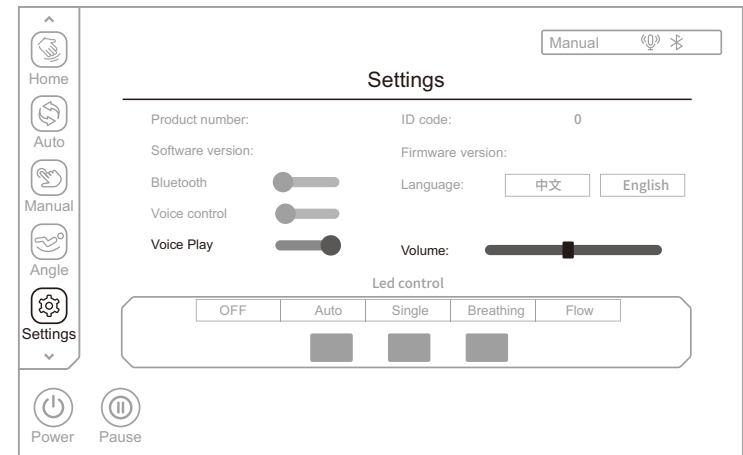

Operation Instructions

7. Ambient lighting control

Ambient lighting mode setting. The functions for setting include OFF, automatic mode, monochrome mode, breathing mode, flow mode, etc. Please set them according to your own preferences.

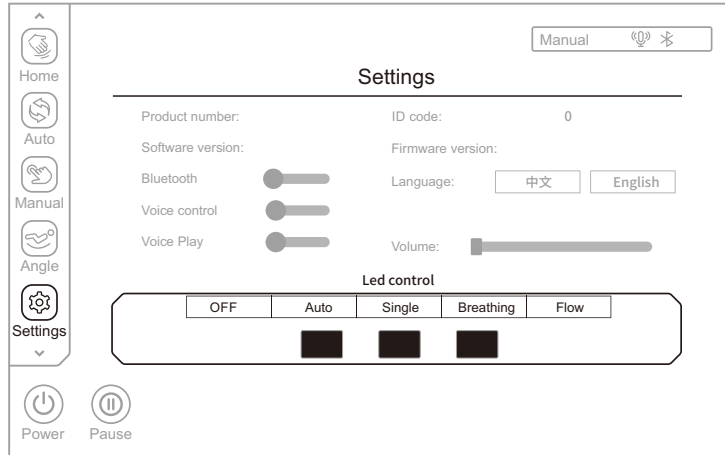

IX. Health detection (please use this function after the equipment is turned on)

Click the "Health Detection" key in the menu bar on the left side of the display to enter the health detection interface, and press the Start Detection key **Start** to start the health detection. After entering the health detection state, gently place the index finger or middle finger on the sensor and wait for the end of the detection.

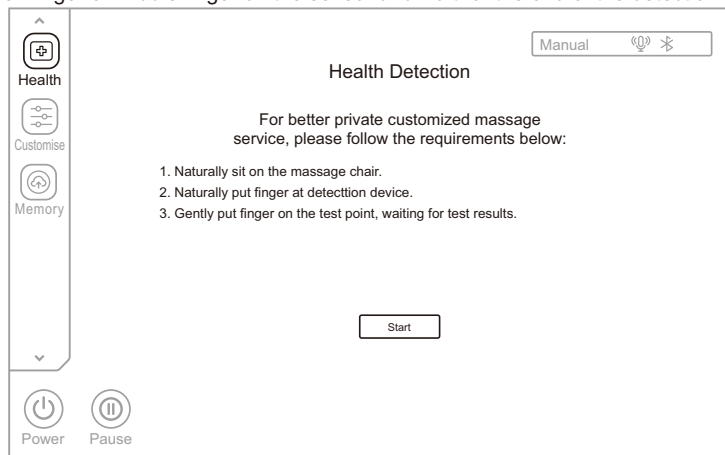

Operation Instructions

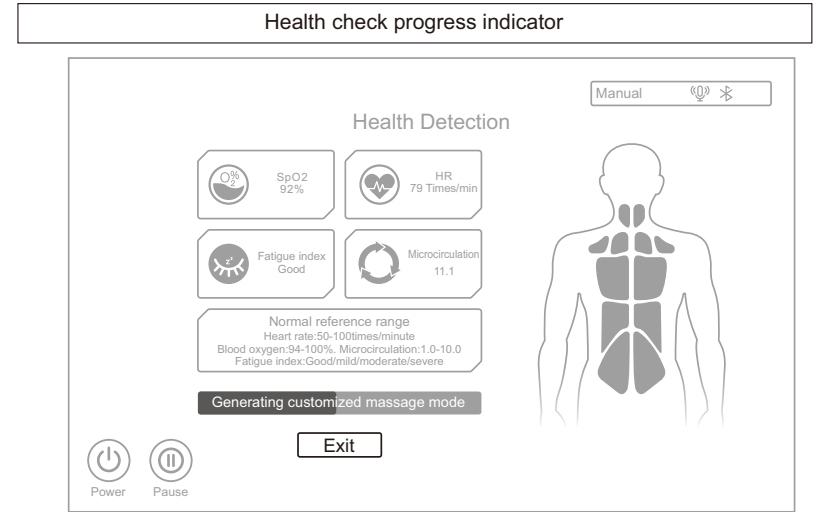

2. Recommended program

When normal detection is completed, it will display the heart rate, blood oxygen, and the fatigue level, respectively. The blood oxygen means with the blood oxygen concentration ranging from 95% to 99% normally. The fatigue levels include Good, Mild, Moderate and Severe. Based on your fatigue level, an automatic program will be recommended for you. Select "Yes" to start using the recommended program and "No" to return to the massage state before the health detection.

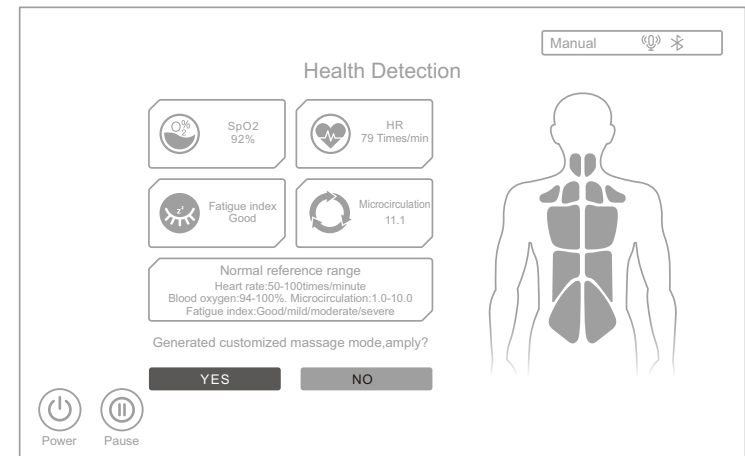

Operation Instructions

3.No valid data is detected.

If no valid data is detected, the user will be prompted to ask whether to re-detect. Select "Yes" to restart the health detection, and "No" to exit the detection and return to the massage state before the health detection.



4.Exit health detection.

During health detection, press the **Exit** key to exit the detection and return to the massage state before the health detection.

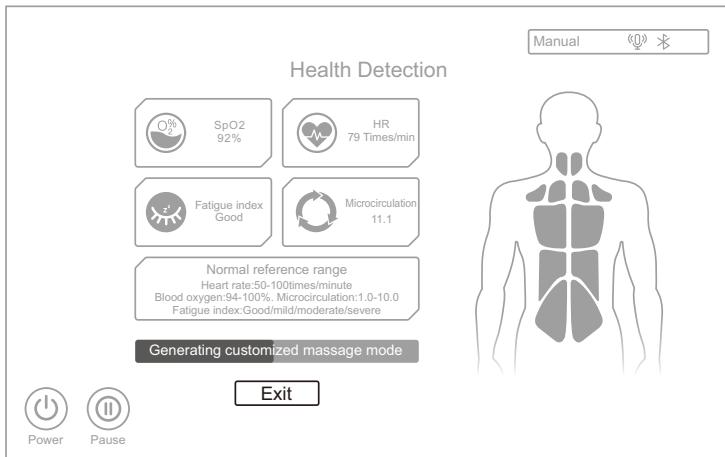

Operation Instructions

X.Custom (please use this function after the equipment is turned on)

Click the "Custom" key in the menu bar on the left side of the display to enter the custom setting interface and select either Custom I or Custom II (only if the corresponding custom has been previously set and saved) for massage.

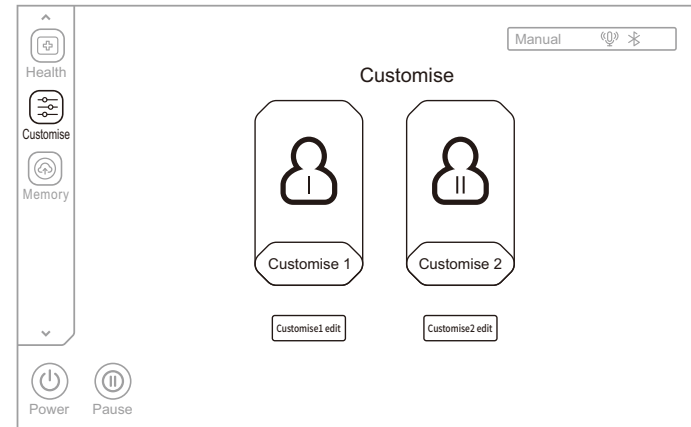

Schematic diagram of Custom

Click Custom I Setting or Custom II Setting to enter the Custom Setting interface, then select the preferred massage technique whose icon will be highlighted after selection, and select the message interval, 4D intensity, air massage, massage width, massage speed, air intensity, back heating, calf kneading and other functions, then click Save to save the current settings as Custom I and Custom II. After the settings are saved successfully, the custom program will be immediately available and can be used for the next massage by clicking the saved custom program.

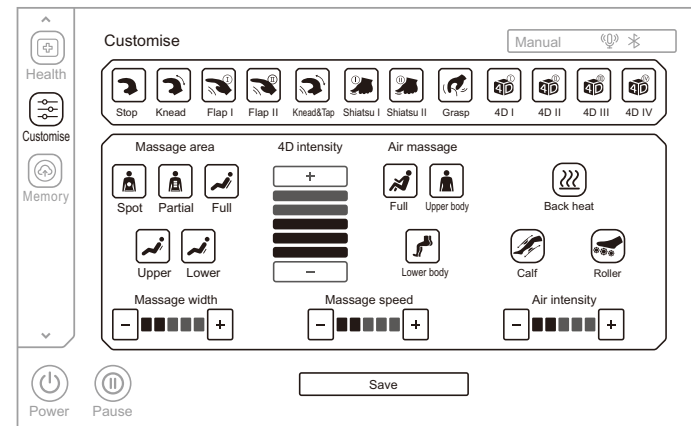



Operation Instructions

XI.Storage (please use this function after the equipment is turned on)

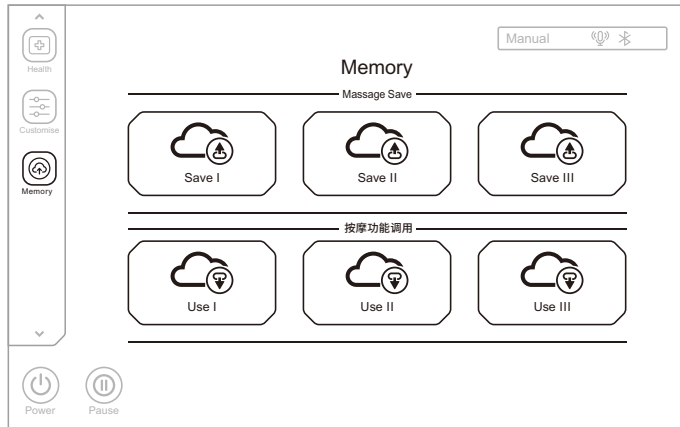

Click the "Storage" key  in the menu bar on the left side of the display to enter the massage function storage selection interface, with two categories including message function storage and message function call. Message storage includes: Storage I, Storage II and Storage III. Message call includes: Call I, Call II and Call III.





Key	Description
	Storage: Saving the currently running massage program, including automatic program, massage technique, air mode and intensity, position and angle of leg unit and backrest unit, and other massage functions.
	Call: Calling the previously saved massage program, including automatic program, massage technique, air mode and intensity, position and angle of leg unit and backrest unit, and other massage functions.

Operation Instructions

XII. Other functions (please use this function after the chair is turned on)

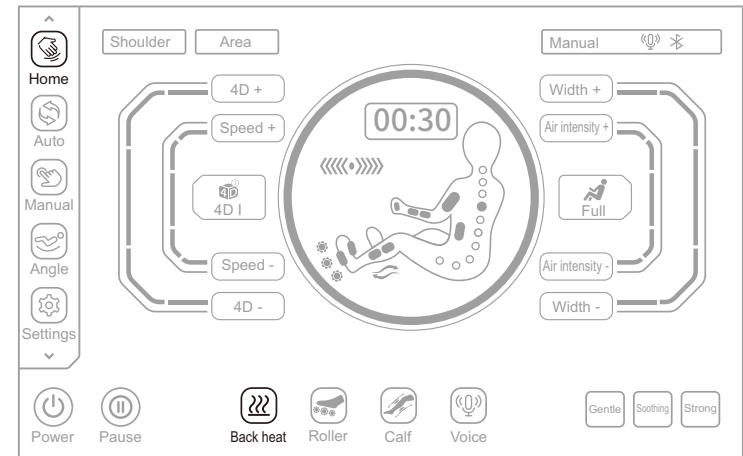

In addition to setting in the Custom interface, the function can also be enabled or disabled by selecting the In the "Current Status  " interface, select the "Back Heating  " key to turn on or off the shawl heating function (for graphene heating). There will be warmth after turning on the heating function for 3 minutes

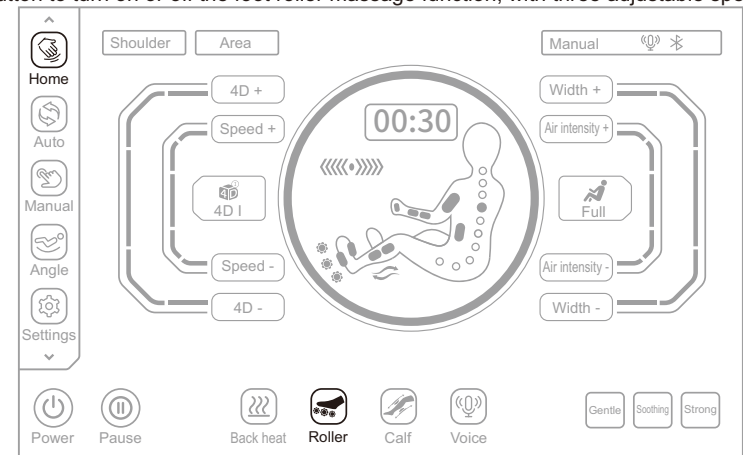

In addition to setting in the Custom interface, the function can also be enabled or disabled by selecting the In the "Current Status  " interface, click the "Roller  " button to turn on or off the foot roller massage function, with three adjustable speeds.



Operation Instructions

Key	Description
   Level 1 Level 2 Level 3	Press this key to enable or disable the Sole Roller function. Press it for the first time to start Level 1 speed; press it for the second time to start the Level 2 speed; press it for the third time to start the Level 3 speed; and press it for the fourth time to disable the Sole Roller function, which are switched cyclically.

In addition to setting in the Custom interface, the function can also be enabled or disabled by selecting the In the "Current Status" interface, select the "Calf" button to turn on or off the calf rubbing massage function; in The inner side of the calf is provided with rubbing massage function, and the outer side is provided with airbag squeeze massage function, which can relieve the calf muscle stiffness or tension caused by long standing.

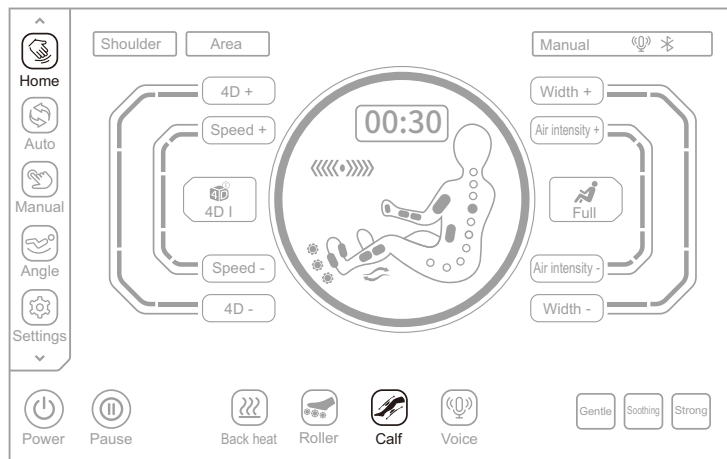

Operation Instructions

In addition to setting in the Custom interface, the function can also be enabled or disabled by selecting the In the "Current Status" interface, select the "Voice" key to wake up the voice assistant.

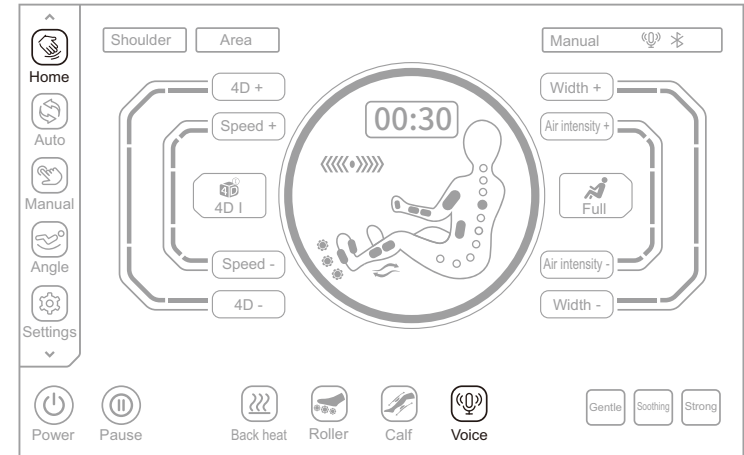

In addition to setting in the Custom interface, the function can also be enabled or disabled by selecting the In the "Current Status" interface, select the "Shoulder Position Adjustment" button, and press the up and down arrow buttons in the pop-up menu to adjust the shoulder position, with a total of 11 adjustable levels.

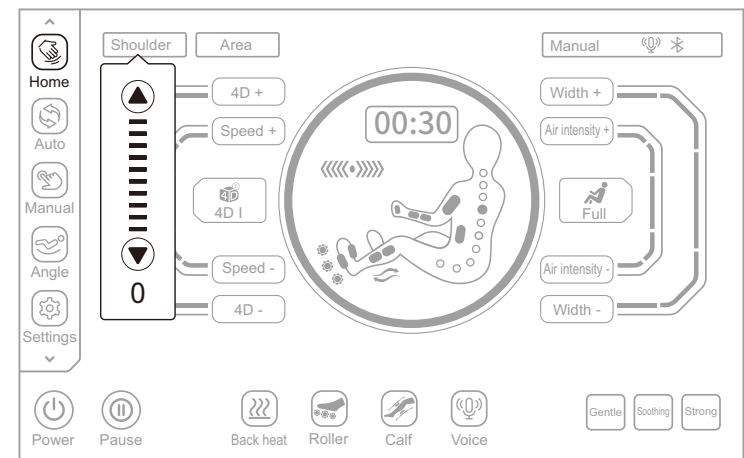

Operation Instructions

In addition to setting in the Custom interface, the function can also be enabled or disabled by selecting the In the "current state" interface, select the "massage time adjustment 00:30" button, press the plus and minus arrow head button in the pop-up menu, you can increase or decrease the massage time. Click the "+" key, the time increased by 5 minutes, the maximum increase to 40 minutes. Click the "-" key, the time decreased by 5 minutes.



In addition to setting in the Custom interface, the function can also be enabled or disabled by selecting the In the "Current Status" interface, select the "Gentle", "Soothing", "Strong" button to select the appropriate massage intensity.

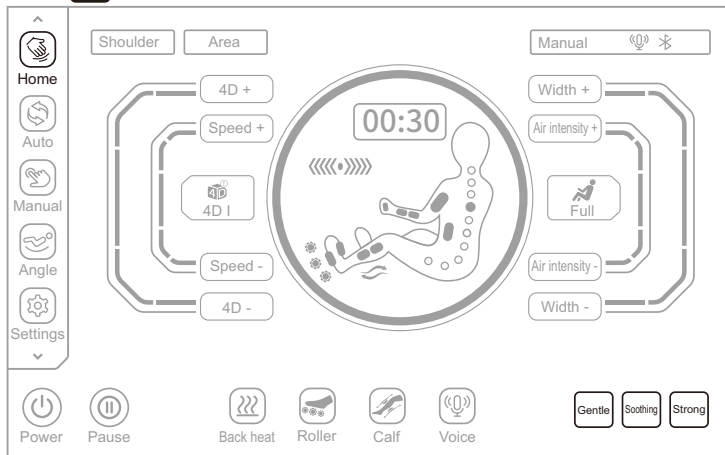

Operation Instructions

XIII. Massage close

During massage, press the remote controller touch switch key or press the right armrest switch key to turn the equipment off. Immediately turn off all massage functions, reset the backrest unit and the leg unit, or when the massage timing time arrives, all massage functions will be automatically turned off, with the backrest unit and the leg unit not reset.

Cut off the whole machine power supply, as shown in the figure (Schematic diagram of power switch position of the whole machine).

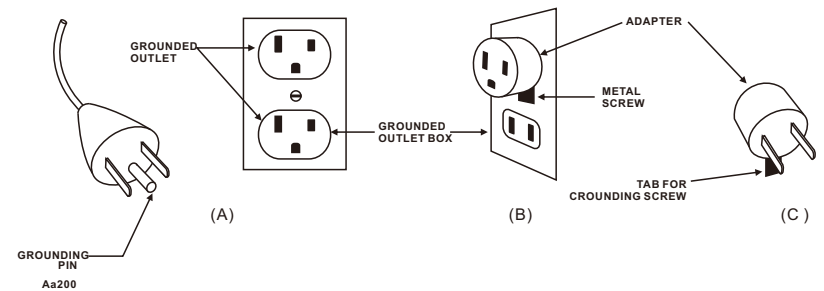
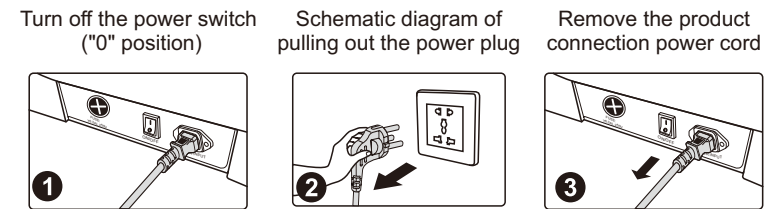

Cleaning and Maintenance

Cleaning synthetic leather and plastic parts

Wipe the leather with a soft, dry cloth.

- Do not use chemicals such as thinner, gasoline, alcohol, etc. to clean the unit.
- When using commercially available leather care products (rags), please follow the instructions for use.
- If synthetic leather is particularly dirty, wipe it in the following way.
 - ① Immerse a soft cloth in water or hot water containing 3% to 5% neutral detergent, then wring it out thoroughly.
 - ② Use the above soft cloth to wipe the leather surface.
 - ③ Wipe off the cleaning solution with a cloth soaked in clean water and thoroughly wrung out.
 - ④ Wipe with a wrung soft cloth.
 - ⑤ Let it air dry naturally.
- When it is difficult to remove stains, please immerse commercially available melamine foam in neutral detergent, and then wipe the machine with it.
- Do not use a hair dryer to dry the surface.
- Be careful when wiping the machine with denim and colored fabrics, as the color of the fabric will stain the surface of the synthetic leather.
- Do not keep these parts in contact with plastic for a long time, as this will cause discoloration.
- Synthetic leather may be discolored, so when using hair dye, please cover the touched part with a towel.

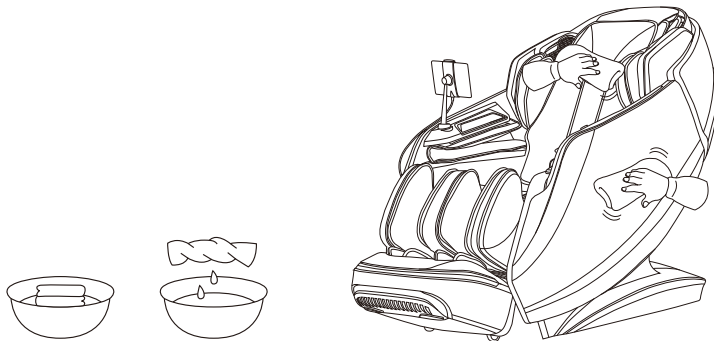

Troubleshooting

Fault	When the calf mechanism or the backrest reaches a certain position, press the corresponding adjustment button and it will no longer change, and a continuous "beep, beep" sound will be emitted.
Solution	Due to product structure design and ergonomic requirements, this product has a limited protection design for the limit state of attitude adjustment. At the same time, a reminder sound will sound when the limit is reached.

Fault	The function does not work or some functions do not work after the machine is turned on.
Solution	After the machine is turned on by pressing the switch key, it is necessary to manually select an automatic massage program or other working state. If it is not operated, the machine will automatically shut down after 20 minutes. If the manual operation mode is selected, the functions that are not selected may be disabled, and the working mode needs to be manually set in the manual mode.

Fault	The machine makes a leather rubbing sound when adjusting its posture.
Solution	This product adopts high-grade anti-corrosion leather that meets environmental protection requirements. Due to the inherent characteristics of leather materials, there will be a normal slight noise when rubbing at the relative movement, which is a normal phenomenon. Note: If you hear fabric or leather tearing sound when the machine is running, please stop using it immediately and seek professional maintenance.

Fault	The massage wheel did not reach the shoulders or neck.
Solution	If the head does not touch the head cushion or the back does not touch the backrest, the shoulder position may be lower than the actual position during the body shape detection process. Sit in the deepest position of the seat, rest your head on the headrest, and start over from the beginning.

Fault	The unit is damaged. The power cord or power plug is abnormally hot.
Solution	To prevent accidents, be sure to contact an authorized service center.

Please feel free to contact the designated service personnel for any questions or doubts about this product.

Product Specifications

Model: Avalon 4D

Name: Massage Chair

Rated voltage: 110-120V~ 60Hz
220-240V~ 50Hz/60Hz

Rated power: 160W

Rated time: 20min

Safety structure: Class I