

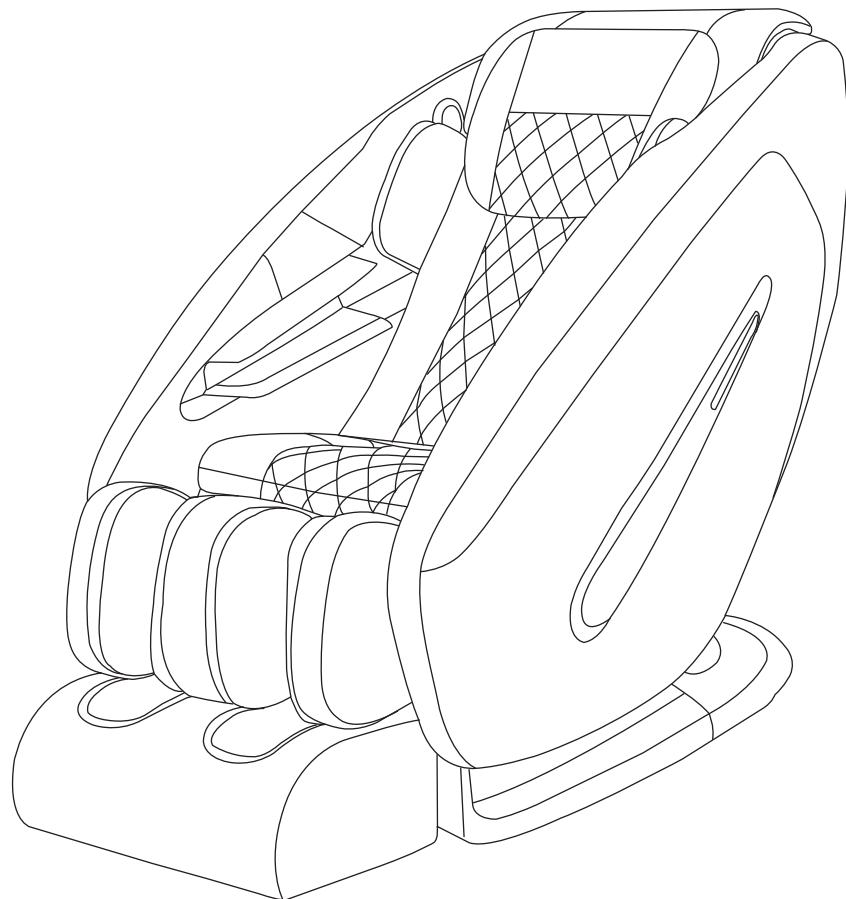

Titan Pro- Commander INSTRUCTION MANUAL

Enjoy the space capsule Massage Chair



PLEASE BE SURE TO READ THIS MANUAL CAREFULLY TO LEARN THE OPERATIONS OF THIS PRODUCT. DO NOT DISPOSE OF THE MANUAL AND KEEP FOR FUTURE REFERENCE.

CONTENTS

I	IMPORTANT SAFETY INSTRUCTIONS	1-4
I	INSTALLATIONS GUIDE	5
I	FUNCTION OF EACH PART.....	5
I	INSTRUCTIONS ON CONTROL PANEL	6
I	OPERATION GUIDE	7-14
I	SAFETY INSTRUCTIONS.....	15
I	DAILY CARE AND MAINTENANCE	15
I	TROUBLE SHOOTING	16
I	SPECIFICATION.....	16

IMPORTANT SAFETY INSTRUCTIONS

OPERATING SURROUNDINGS

- Do not use or store the massage chair in a damp environment : i.e. bathroom, sauna, spa to avoid any mold, electric shock, fire or mechanical failure.
- Do not use the massage chair outdoors
- Do not use the massage chair under dusty, smearable, or anoxic conditions
- Do not place the massage chair near a heater, stove, or near sunlight radiation to avoid inner components overheating and causing fire
- Make sure to place the massage chair on a flat level ground
- The bracket part should be placed on the plain ground
- To avoid electric shock, please make sure to connect an earth wire and have it grounded.
- Don't use the machine while smoking

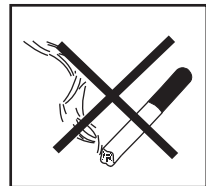
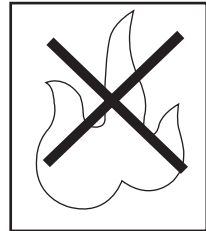

FOLLOWING CONDITIONS SHOULD CONSULT DOCTORS BEFORE USE

- Suffered from malignant tumor
- Serious heart disease
- Serious skin disease
- Serious bone hyperplasia
- During Pregnancy
- Be on the rest cure under the doctor's supervision
- If there is a bend in the back caused by an accident or disease
- Needing peaceful surroundings
- Arthritis Disease
- Implanted pacemaker for medical purpose
- Suffered from bowels disease (i.e. gastritis, enteritis, diarrhea, hepatitis)
- Serious blood circulation trouble
- Consciousness trouble
- In hyperpyretic

WARNING

Children under the age of 18 or people with disabilities (physical and mental) are not allowed to operate the massage chair without a doctor's consent to prevent cases of electric shock, injuries, or mechanism malfunctions.

IMPORTANT SAFETY INSTRUCTIONS

For safety reasons and in order to clearly indicate potential dangers should the product be used improperly, instructions have been marked in the following manners and should be strictly noted

⊘ CAUTIONS

Non-professional technicians are not allowed to dismantle or repair the chair to avoid fire, electrical shock or serious harm



Do not spray or directly pour liquids to the switch when cleaning to avoid insulation fault, electrical shock or short-circuiting.



When moving the chair in the process of storing or maintenance, be sure to disconnect the power plug from socket



Do not detach the plug with wet hands

Make sure to shut off and detach the power plug when cleaning or storing product



During cleaning or moving the machine, make sure to detach power cord to avoid fire or electrical shock

Do not place the machine onto an unstable surface to avoid roasting, insulation failure, electrical shock or turnover



When storing the machine, make sure to disconnect power plug to avoid fire caused by electricity leaking

Clean power plug periodically to avoid fire due to dust



Do not use it in any unsafe places or for other purposes



It is the main reason of product damage or accident

Do not store the machine onto an unstable surface



Unexpected earthquake or external force will cause damage or injury

Keep supply cord unobstructed at all time, i.e. not twisted, knotted, over flexed or pulled and do not place anything heavy on it



The appliance has a heated surface. Persons insensitive to heat must be careful when using the appliance.



IMPORTANT SAFETY INSTRUCTIONS

⊘ CAUTIONS

Do not modify the structure or change components by unauthorized person

Do not dismantle the machine by unauthorized person to avoid electrical shock, short-circuit or fire



Do not store it near a fire or flammable substances

It is one of the reasons of causing product manipulation, deviation, or damage



Should any abnormality occur(i.e. scorching smell), stop using immediately and detach power plug from socket

Operating under an abnormal situation will cause fire or electrical shock, please contact your local seller or authorized service agent for maintenance



Do not place the machine onto an unstable surface to avoid roast, insulation failure, electrical shock or turnover



Only rated voltage must be used



Stop using immediately if supply cord or power plug be damaged or loosen



Be sure to keep children away during operating to avoid any hazard



Do not explore it under sunshine at all time



If the supply cord is damaged,it must be replaced by the manufacturer or its authorized persons for repair or maintenance to avoid any hazard



IMPORTANT SAFETY INSTRUCTIONS

FCC STATEMENT

1. This device complies with Part 15 of the FCC Rules. Operation is subject to the following two conditions:

- (1) This device may not cause harmful interference, and
- (2) This device must accept any interference received, including interference that may cause undesired operation.

2. Changes or modifications not expressly approved by the party responsible for compliance could void the user's authority to operate the equipment.

This equipment has been tested and found to comply with the limits for a Class B digital device, pursuant to part 15 of the FCC Rules.

These limits are designed to provide reasonable protection against harmful interference in a residential installation. This equipment generates, uses and can radiate radio frequency energy and, if not installed and used in accordance with the instructions, may cause harmful interference to radio communications. However, there is no guarantee that interference will not occur in a particular installation.

If this equipment does cause harmful interference to radio or television reception, which can be determined by turning the equipment off and on, the user is encouraged to try to correct the interference by one or more of the following measures:

- Reorient or relocate the receiving antenna.
- Increase the separation between the equipment and receiver.
- Connect the equipment into an outlet on a circuit different from that to which the receiver is connected.
- Consult the dealer or an experienced radio/ TV technician for help.

FCC Radiation Exposure Statement:

This equipment complies with FCC radiation exposure limits set forth for an uncontrolled environment. In order to avoid the possibility of exceeding the FCC radio frequency exposure limits, Human proximity to the antenna shall not be less than 20cm (8 inches) during normal operation.

INSTALLATIONS GUIDE

Leg rest Installation

- ▶ First put the fixed axis of the leg rest into the fixed seat of the seat frame, then close by screwing on two pieced gasket with a screwdriver to tighten the both sides of the screw. At the same time connect the wire with the air pipe.

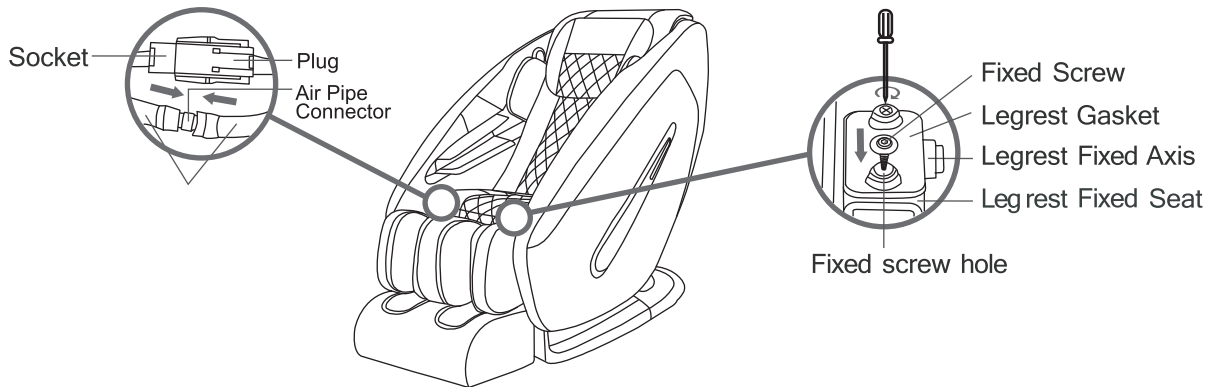

Cape installation and hand controller connection method

- ▶ The connection of the Cape installation and hand control power cord.
- ▶ The magic shawl buckle, pull the leg cushion and cushion connecting zippers.
- ▶ The power line of the manipulator with docking fixed nut.

FUNCTION OF EACH PART

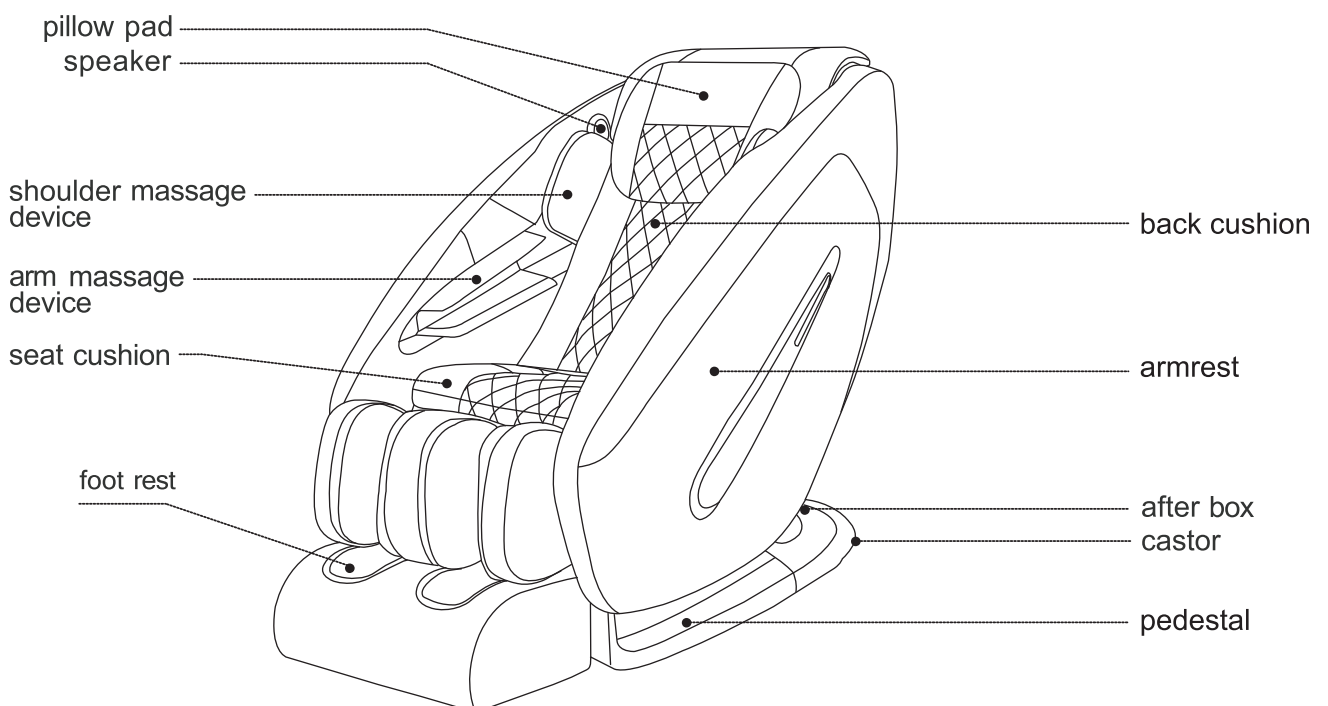

INSTRUCTIONS ON CONTROL PANEL

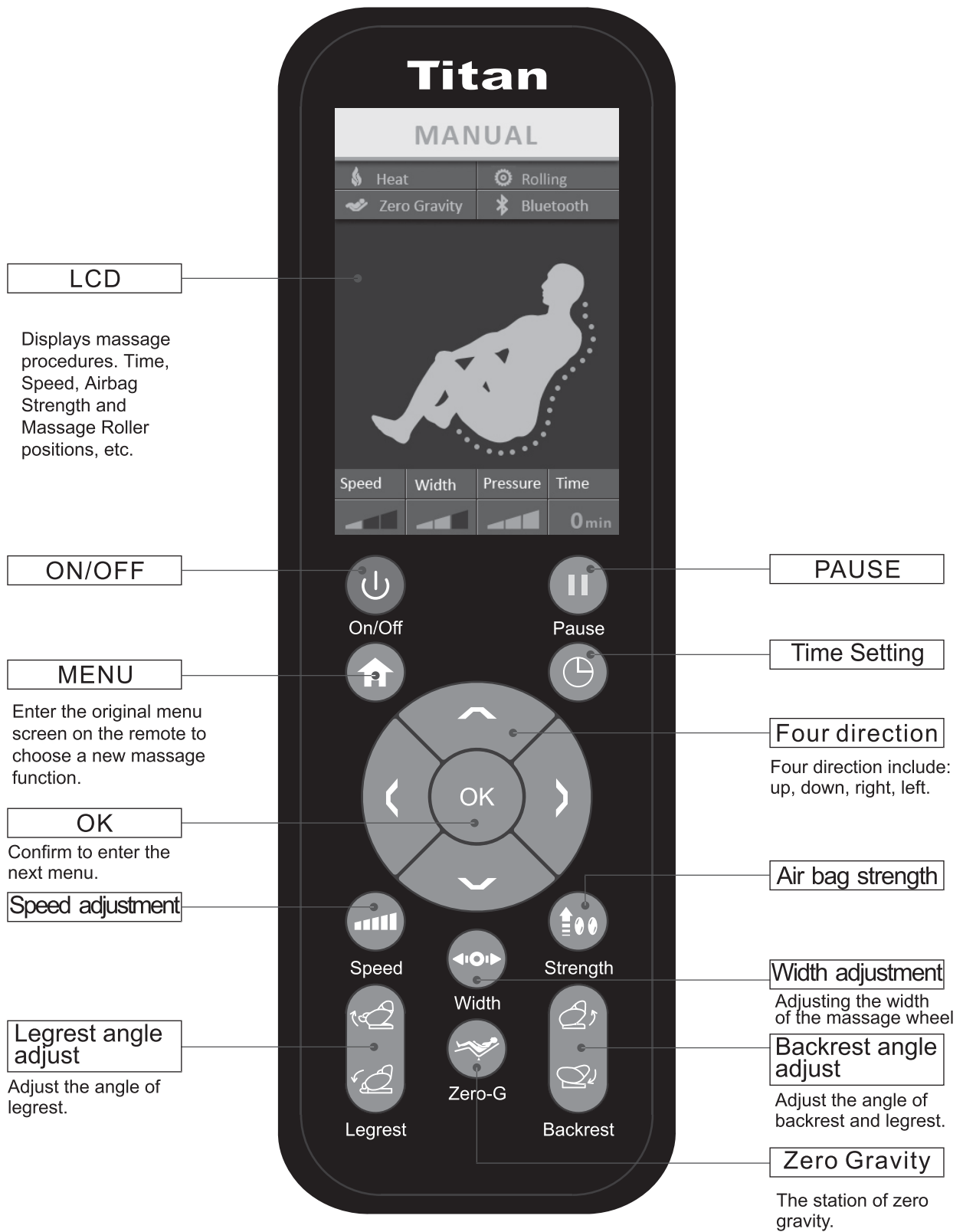

Warning: Only rated supply 110V must be used to avoid damage to electronic elements.

OPERATION GUIDE

1. Turn on the power and turn the switch into the “I” position.

- ▶ First, insert the power cord into the massage chair rear tail box socket. Note that the power switch is cut to (I) the position the machine’s reset condition (Touching this power switch will reset the device). The hand control device “on / off” key indicator will flash quickly. After the reset, turn the machine into standby mode, manually “ on / off” button indication light will flash slowly.

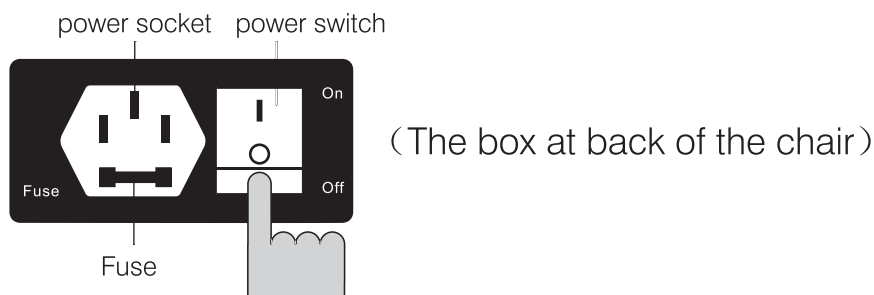

2. Sit on Massage chair and press the ON button to start.

- ▶ Sit in the massage chair, and start the the chair. Press the On button, turn on a massage mode in the suitable position. Press “ Time Setting” button to adjust the time by your desire. Maximum time is 30 minutes.



On/Off



Time Setting”

3. Adjust backrest cushion and leg rest cushion to a favorable angle.

- ▶ When pressing the control keys of the “back-leg ascends”, “back-leg descends”, the chair will start to adjust the angle of the back and calf. When you adjust the angle to the appropriate position, loosen the control key to position.



Backrest

Back ascends simultaneously with leg descending. Back descends simultaneously with leg ascending.



Legrest

leg ascends

leg descends



Zero Gravity

the station of zero gravity.

4. After using, restore massage chair

- ▶ Press restore button after using. Do not stand in the leg cushion before it restores to original position to prevent any damage to leg cushion.







OPERATION GUIDE

5. Start to massage

Automatic course

Automatic massage program introduction

Operation method:

1. Press the “” menu button to return to the main menu.
2. Press the “ ” left and right arrow keys, select the "automatic program" tab: then the “ ” up and down arrow key to select the correct auto-massage programs, and then press the “” OK button to confirm, the machine into the automatic shoulder position detection function, after the test is finished, (at this point press the up and down arrow keys to fine tune and select a suitable massage roller position) and press the OK button, start automatic massage programs.

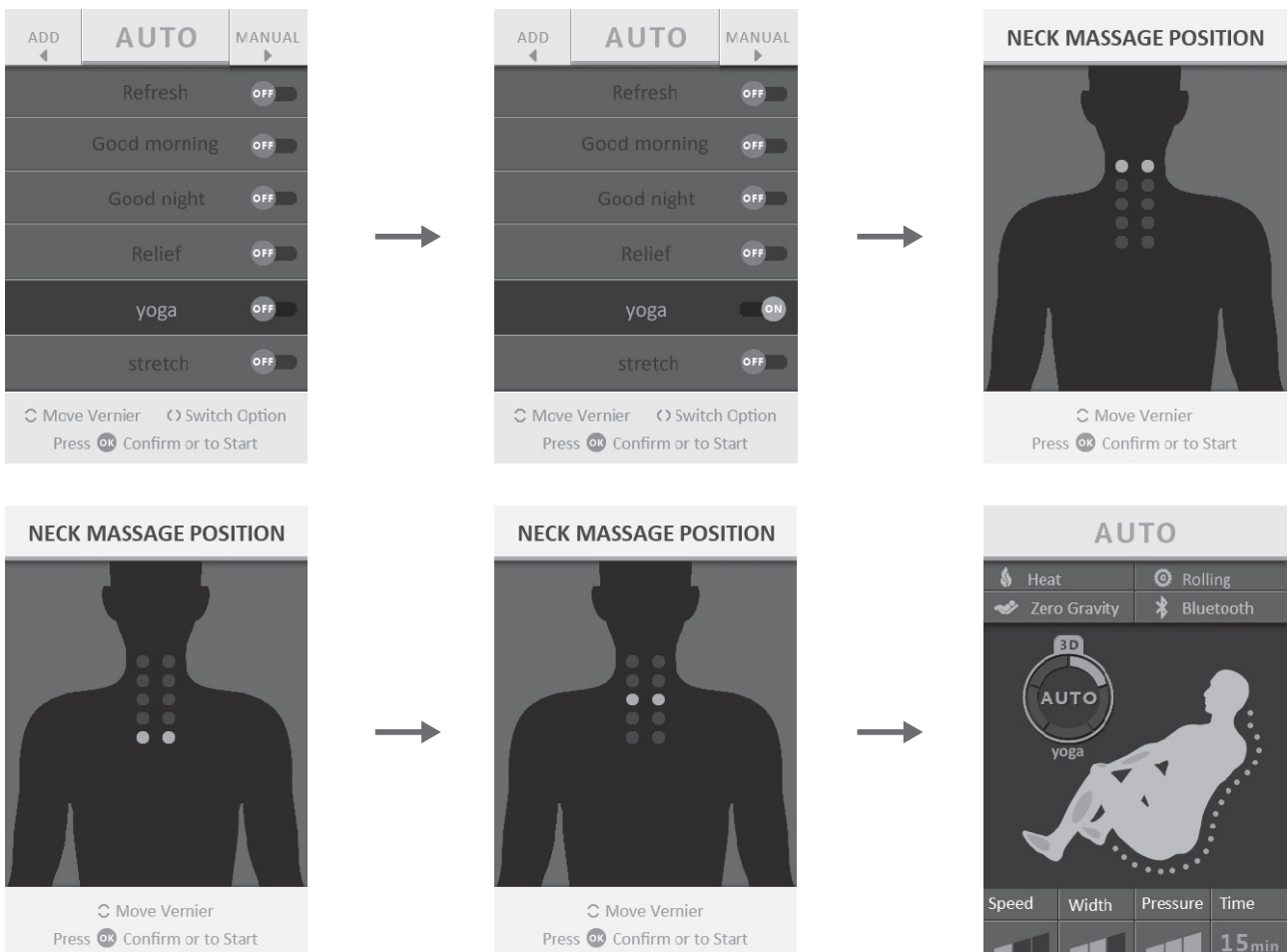

※ Automatic massage programs including the following massages. Each program massage different locations: Kneading finger, pressing, beating, soft hammer, and pressure.

OPERATION GUIDE

Full automatic massage program

Option	Description	Main function and adjustable range
Refresh	Refresh Massage Program	※ Switching from Shiatsu to the Main Massage program
Good Morning	Good morning massage program	※ Combine with kinds of tapping techniques for back, arms, and legs to relax your full body and wake you up.
Good Night	Good night massage program	※ Gentle relaxation course based on tapping actions promoting aid in sleep.
Relief	Relief massage program	※ Engages the body into a relief program, by slow kneading and transitioning
Yoga	Yoga massage program	※ Standard course for thorough stretch and relaxation based on certain positions.
Stretch	Stretching and relaxing massage program	※ Engages the full body into a stretching program.

- ※ The above programmed massage is timed by default to 15 minutes. The setting value of the air pressure is moderate, choose the “strength” key to adjust the pressure intensity.

Play music

Connecting to Bluetooth





- ▶ To manually connect, first open the Bluetooth Function of the mobile phone, then select the matching Bluetooth Devices (codenamed: “ BK8000L “ a “beep” sound connects, beep twice and it will disconnect). Standby for the mobile phone will automatically match the massage chair speakers to your phone.

OPERATION GUIDE

Manual massage program

Introduction of manual massage program

Operation method:

1. Press the “” menu button to return to the main menu.
2. Press the “” left and right key, select the "manual program" tab: use the “” up and down arrow keys to select the manual massage program you need, and then press “” OK to determine.

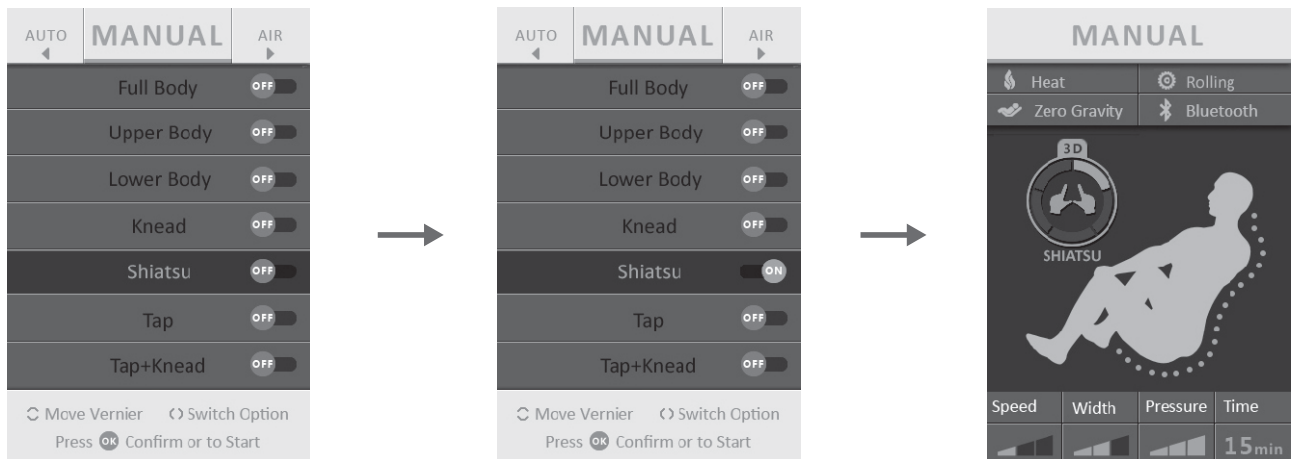

Option	Description	Main function
Full body	Full body massage	Select full body massage function
Upper Body	Upper body massage	Select upper body massage function
Back	Back massage	Select back massage function
Lower Body	Lower body massage	Select lower body massage function
Kead	Kead massage	Kneading massage, can adjust the intensity.
Shiatsu	Shiatsu massage	Shiatsu massage, can adjust the width.
Tap	Tapping massage	Tapping massage, can adjust the intensity and width.
Tap+Kead	Tap+Kead massage	Tapping+Kneading massage, can adjust the intensity.

OPERATION GUIDE

Manual massage program

Button	Description	Main function and adjustable range
	Speed adjustment	Speed adjustment of massage wheel
	Wide narrow regulation	Speed adjustment of massage wheel

※ For the above manual setting course, the default setting is spot-specific massage with medium width. Speed and width is adjustable by pressing relative button. (and)

Pressure massage program

Introduction of all kinds of functional buttons, it suitable for automatic manual massage program.

Operation method:

1. Press the “” menu button to return to the main menu.
2. Press the “” left and right keys, select the “air pressure program” tab: and then “” up and down the direction keys, select the air pressure massage procedures you need, and then press “” OK to determine.

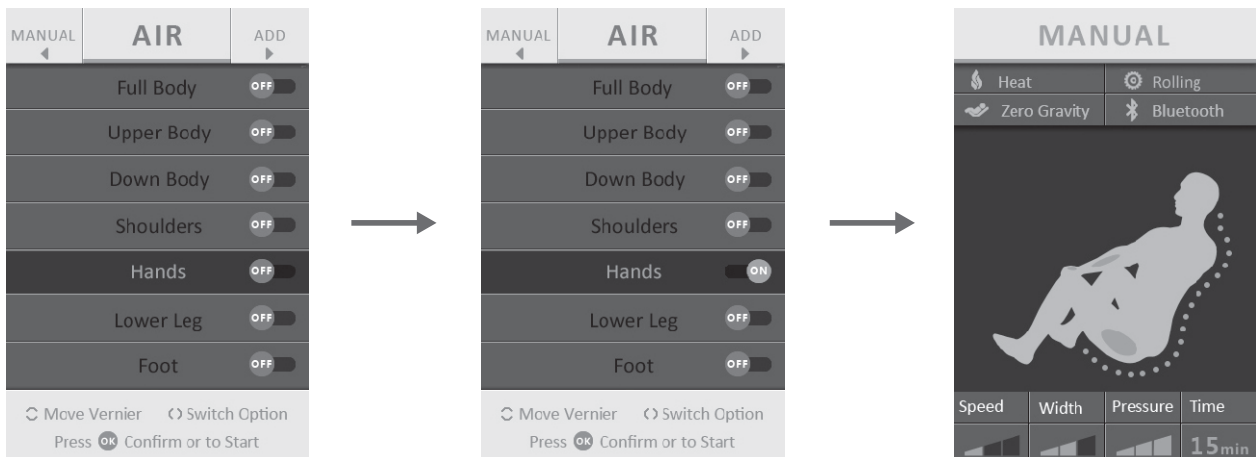

OPERATION GUIDE

Air pressure massage program

Option/Button	Description	Main function and adjustable range
Full body	Full body pressure	Body Pressure Massage Manual Program. The initial strength of the set value can be individually operated.
Upper body	Upper body pressure	The upper body air pressure massage manual program. The initial strength of the set value can be individually operated.
Down body	Down body pressure	The lower body air pressure massage manual program. The initial strength of the set value can be individually operated.
Shoulder	Shoulder pressure	Air pressure massage manual program. The initial strength of the set value can be individually operated on and off.
Hand	Hand pressure	The hand pressure massage manual program. The initial strength of the set value can be individually operated open and close.
Lower leg	Leg pressure	Leg pressure massage manual program. The initial strength of the set value can be individually operated on and off.
Foot	Foot pressure	Foot pressure massage manual program. The initial strength of the set value can be individually operated on and off.
	Pressure strength	Airbag massage intensity adjustment. Circle button adjusting widest, medium, to narrow.

※ All the above massage program can adjust the intensity of the initial design value, can press the “” button to adjust.

⚠ Warning: Supervision and guidance are disabled mentality and physically. Those who do not have knowledge or a lack of understanding of this massage chair (including children) must not use the chair unless they are supervised by someone who is in charge of their safety. Please make sure to take extra care of children and make sure that the chair is not used for play. There is heat function in this chair, those who are sensitive to heat, should take extra precaution.



OPERATION GUIDE

Additional function

Introduction of additional function keys

Operation method:







1. Press the “

Option/Button	Description	Main function and adjustable range
 Rolling	Rolling massage	Rolling massage exclusive program. Can be turned on and off alone.
 Heat	Heating massage	Heatingmassage exclusive program. Can be turned on and off alone.
한국어	Korean	Korean language.
繁體中文	Traditional Chinese	Select traditional Chinese language.
简体中文	Simplified Chinese	Simplified Chinese language.
English	English	Choose English language.

OPERATION GUIDE

Pause and end massage

Operation method:

1. Press the “  ” pause button, then the machine to suspend the massage function.
2. If you need to continue the massage. Please select "Continue" and, press the “  ” OK key to confirm, then the machine will continue the massage function.
3. If you need to return to the main menu. Please click on the next button, select the "Main Menu" option: press the “  ” OK key to confirm, then return to the main menu.
4. If the need to stop the massage. Please press the “  ” up and down keys, select the "Stop" option: press “  ” OK key to confirm, then the machine will end the massage.
5. At the end of the machine massage stroke press “  ” up and down key and “  ” OK key, can choose "yes" or "no" to end or continue massage.

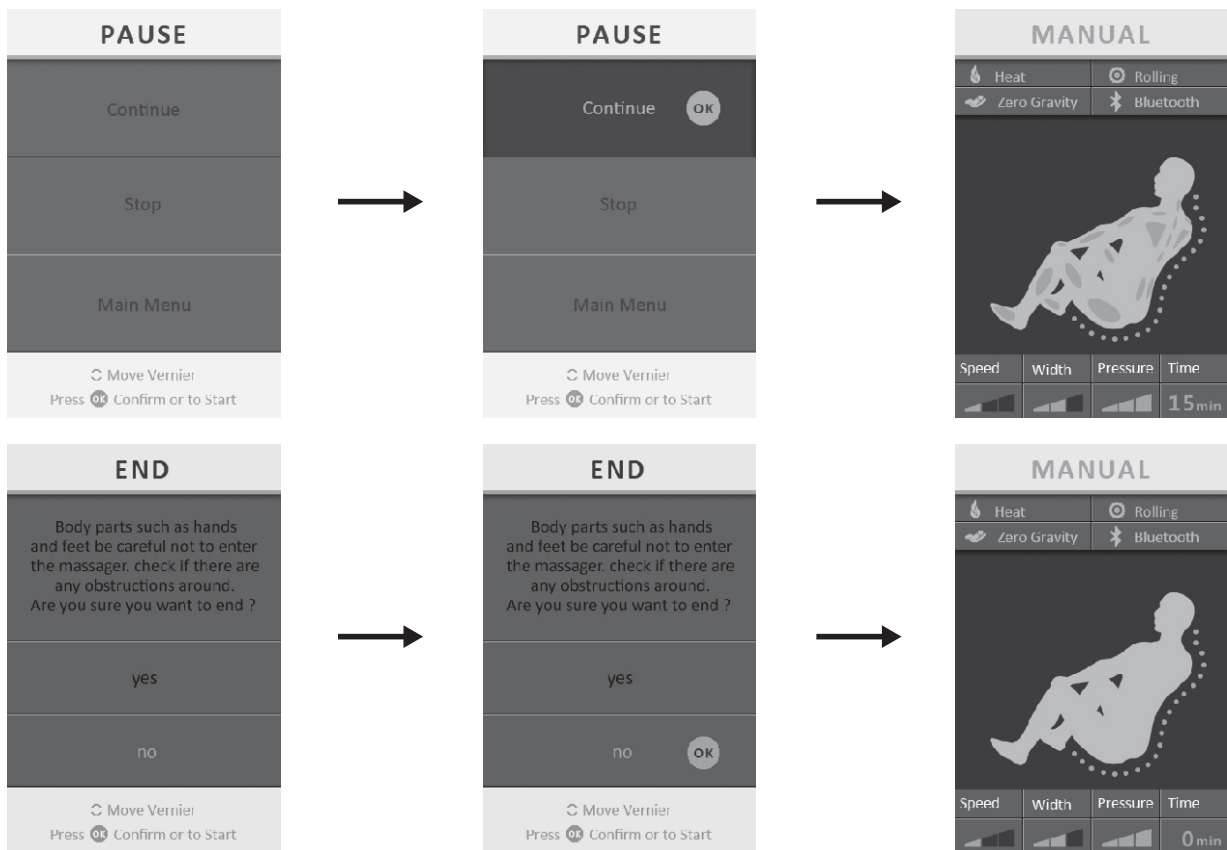

Option	Description	Main function
Continue	Continue to massage	The function to continue to massage.
Stop/End	End of the massage	Choose to end the massage.
Main Menu	Main menu	Choose to return to the main menu.
Repeated	Repeated massage	Select to repeat massage

SAFETY INSTRUCTIONS

1. Should any abnormality occur, shut off and detach power plug from socket.
2. When the power cord is damaged, it must be changed from a special power cord available from the manufacturer or the service department.



Warning: Do not dismantle, modify, or change components by unauthorized person to avoid electric shock or fire.

DAILY CARE AND MAINTENANCE

Storage guide

- © Do not dismantle back of the chair. Electrical shock may happen when in touch with the inner elements of chair.
- © An unauthorized person must not dismantle the chair to avoid electric shock or fire.
- © Make sure to shut off and detach the power plug when cleaning to avoid electric shock or hazard.
- © Keep the massage chair clean and free of dust. Do not place the massage chair in a damp environment.
- © If not in use for a long period, please cover it with a cloth to free dust.
- © Do not place the massage chair under sunlight.

Maintenance

- © Use neutral detergents only
- © Use neutral detergents to clean the back cushion, head cushion, and leg cushion. Let it dry.
- © Use detergent and cloth to clean the plastic, pipe and leather material of massage chair.
- © Make sure not to use organic solvents as gasoline, amyl acetate, benzene for cleaning to avoid fading of the color, aging, or breakage.
- © Do not spray pesticide to avoid electric shock or fire.
- © Please clean with dry cloth to avoid mechanical failure.

Controller maintenance

- © Do not place the massage chair near heat or fire.
- © Keep away from dampness to avoid electric shock.
- © Please clean dust with a soft cloth or a small banister brush.
- © Make sure not to use violent detergent such as benzene, gasoline, amyl acetate.

TROUBLE SHOOTING

Checking is necessary in frequent usage.

Make sure the machine work properly before usage, after not in use for long time.

Abnormality situation	Solution guide
Failure to start and indicator light is off	<ul style="list-style-type: none"> © Check that the plug is well connected © Check if the switch on the chair is turned to "I" position
Sound in operation	<p>The sound is normal in following situation</p> <ul style="list-style-type: none"> © Sound for kneading or knocking © Sound changes after speed adjustment © Sound from the box in massage © Vibration sound for backrest in massage © Sound for air input and output © Sound for airbag inflating and venting © Sound for leg adjustment © Sound for motor when the massage chair is loaded

SPECIFICATION

Product name	Massage Chair
Model	Titan Pro-Commander
Power supply	120V~ 60Hz
Rated power	150W
Rated working time	15 min