

Engineered by *Osaki*



AD-Allure MASSAGE CHAIR

OPERATION INSTRUCTIONS

SAVE THESE INSTRUCTIONS

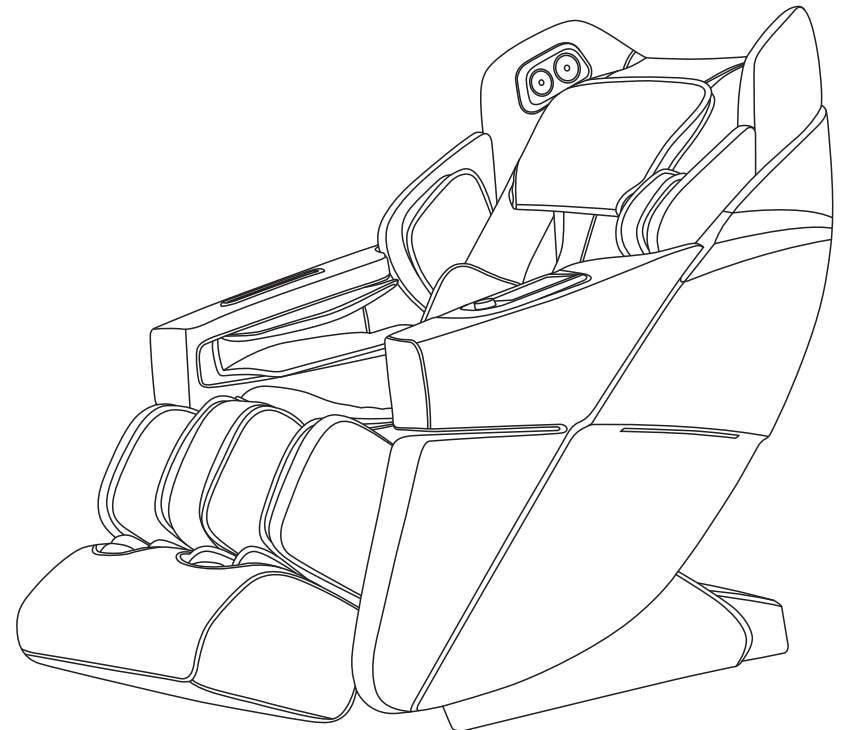

Thanks for purchasing this product. Please read this manual instruction carefully in order to know how to use this product correctly before operation. Please pay more attention to some important safety warning and keep this manual book properly for future use.

Note: Our Company reserves the right to revise the design and description of this product without any further notice. Please refer to the actual color of this product.

TABLE OF CONTENTS

Safety and Maintenance	02-03
Safety Warning	04-06
Name of Components	07
Function	08-09
Introduction to the Remote Controller	10-11
Method of Usage	12-39
I.Turn on the power supply of this product	12
II.Massage Function Control Operation	12-31
III.Introduction to Armrest Shortcut Keys	32-33
IV.Voice Control Mode	34
V.Operation Instructions for Bluetooth Speaker Play	35
VI.Turn off the power and stop massage	35
VII.Installation Instructions for Armrests	35-36
VIII.nstallation Instructions for Legrest	37
IX.Instructions for Removal and Use of Head Cushion and Backrest	38
X.Floor Protection	38
XI.Instruction for Movement	39
Product Specification	40

Safety and Maintenance

1. Important Safety Warnings

- Do not allow children to touch any movable part of this product.
- Use the well-grounded power supply unit suitable for this product.
- Pull out the plug after use or before cleaning to avoid any physical injury or damage to the product.
- Operate this product as instructed in this manual.
- Do not use any parts or accessories which are not recommended.
- Do not use this product outdoors.
- Please read the Operation Instructions carefully before operation.
- Never use this product for any other purpose not listed herein.
- 20 minutes of usage each time is recommended.
- Do not use this product if the leather is broken or damaged.
- Do not use this product if the cover or leather is broken or damaged.
- Do not use this product if the radiator hole is covered or blocked.
- Do not drop anything into this product.
- Never fall asleep while using this product.
- Do not use this product if you are drunk or feel unwell.
- Do not use this product within one hour after a meal.
- Do not use this product with excessive force to avoid any injury.
- Do not carry any fragile, explosive, or combustible material in your pocket, such as a mobile phone and lighter when using the massage chair.

2. Operating Environment

- Do not use this product in a very moist environment such as the bathroom.
- Stop using this product immediately when the ambient temperature changes sharply.
- Do not use this product in any heavily-dusty or caustic environment.
- Do not use this product in a small space or a place without good ventilation.
- The normal room temperature ranges from 0 °C to 35 °C.
- Do not use this product in an excessively humid room such as a bathroom. Use it at a relative humidity between 20% and 80%.
- Do not use this product outdoors.
- Avoid direct sunlight.
- Keep this product away from any heat source such as a stove and air outlet of an air conditioner.
- Do not use this product during thunder or lightning weather.
- Do not use this product in dusty places.

3. The following populations should not use this product:

- Patients with osteoporosis.
- Patients with heart disease or wearing electronic medical devices such as a pacemaker.
- People who have a fever.
- Pregnant women or women on their menstrual period.
- Patients who are injured or have a skin disease.
- When unsupervised, any children are under the age of 14 and those unconscious are not allowed to use this product.
- People who are told by their physicians to have rest or who feel unwell.
- People whose bodies are wet are forbidden to use this product.
- This product has a hot surface. Persons insensitive to heat must pay attention when using this product.

Safety and Maintenance

4. Safety Precautions

- Check whether voltage is consistent with the specification of this product.
- Never insert or pull out the plug with a wet hand.
- Do not let water flow into this product to avoid electric shock or cause damage to this product.
- Do not pull the power cord when plugging or unplugging it. Rough handling is forbidden.
- Do not damage the wire or modify the circuit of this product.
- Do not clean live parts of this product with a wet cloth such as a power switch and plug.
- Be away from this product in case of power failure to avoid any injury if power is restored suddenly.
- Stop using this product at once while it works abnormal, and consult your local supplier.
- Stop using this product if you feel unwell, and consult your health care practitioner.
- This product is not intended for use by persons (including children) with reduced physical, sensory or mental capabilities, or lack of experience and knowledge, unless they have been given supervision or instruction concerning the use of this product by the personnel responsible for their safety. Children should be supervised to ensure that they do not play with this product.
- If the power cord is damaged, it must be replaced by the manufacturer, its service agent or similarly qualified staff in order to avoid hazards.

5. Product Service and Maintenance

- This product should be maintained by the service center designated by the manufacturer only. No user should disassemble or maintain it without permission.
- Do not forget to turn off the main power switch after usage.
- Do not use this product if the power socket becomes loose.
- If this product will be left unused for a long period of time, it is necessary to roll up the power cord of this product and store this product in a dry and dust-free environment.
- Do not store this product at a high temperature or near open flame. Avoid prolonged exposure to direct sunshine.
- Please clean this product with dry cloth. Never use thinner, benzene or alcohol.
- The mechanical components of this product are specially designed and manufactured, so no special maintenance is needed.
- Do not use a sharp object to stab at this product.
- Do not roll or pull this product on any uneven ground. Instead, it should be lifted before moving.
- Please use this product intermittently. Do not keep it working continuously for a long period of time.

6. Solutions to Ordinary Malfunctions

- If the motor sounds during operation of this product, this is the normal operation sound.
- If the controller cannot work normally, check whether the plug and the power socket are connected reliably, and whether the power switch is turned on.
- If the rated working time is over, this product will automatically activate the power-off button; If this product keeps operating for a long period of time, the temperature protector will stop this product automatically. The product can be used again after half an hour.

7. Storage Conditions

- Storage room temperature: -5 °C to 35 °C.
- Relative humidity (RH) between 20% and 80%; free of corrosive gases, and a well-ventilated room.

Safety Warning

⚠ Warning

When the legrest of the massage chair is lifted, nobody should apply pressure on the legrest to prevent the massage chair from falling forward which will damage this product or result in personal injuries.

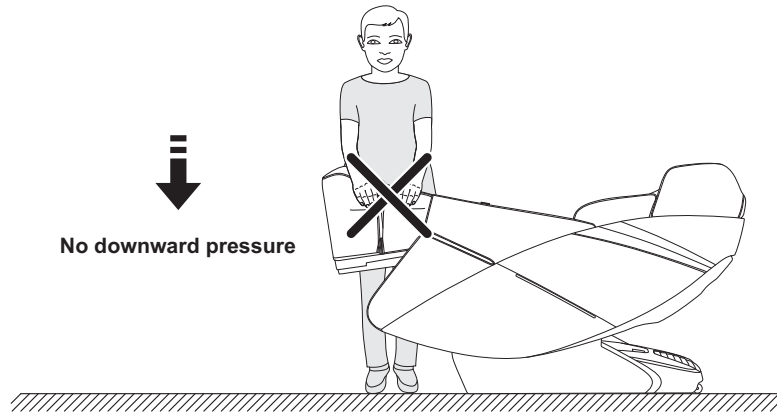

⚠ Warning

Before sitting on the massage chair, make sure that the massage chair manipulator does not stay in the seat cushion position to avoid discomfort to the buttocks during the body pressing down and any damage to the massage chair manipulator.

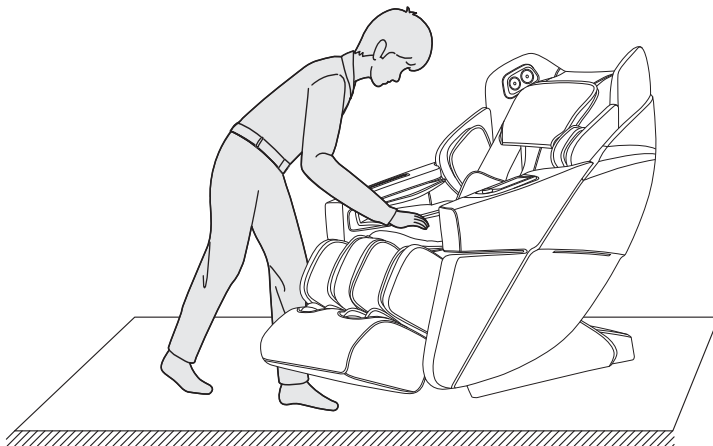

04

Safety Warning

⚠ Warning

Do not remove or pull out the remote controller cable or the power cord in the standby or power-on state to avoid any damage to this product or accidental electric shock of a body part. You are advised to unplug the remote controller cable and the power cord and put them away after you use the massage chair.

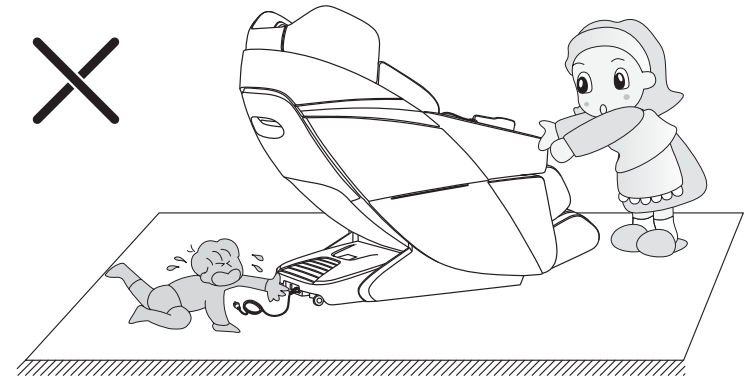

⚠ Warning

When the zero-gravity lying function is enabled, be sure to check whether there is any child or pet staying or playing under the bottom of the legrest and backrest, in order to avoid any damage to this product or physical injury.

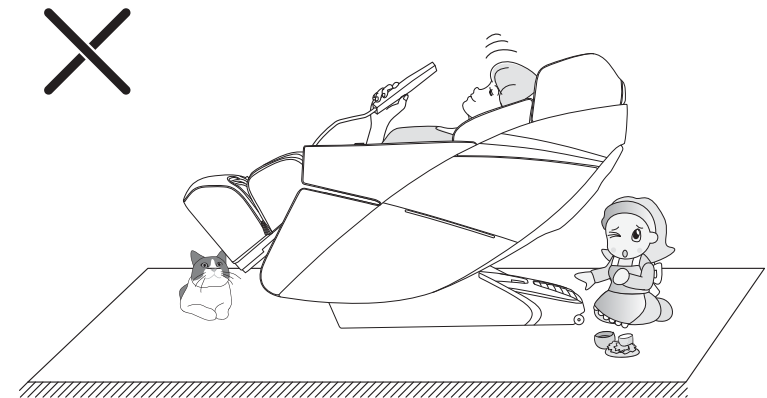

05

Safety Warning

Warning

Before using the massage chair, remove any hard objects in your pocket(s) or any jewelry carried with you (e.g. key, watch, other similar portable hard objects) to avoid any damage to this product or physical injury during massage.

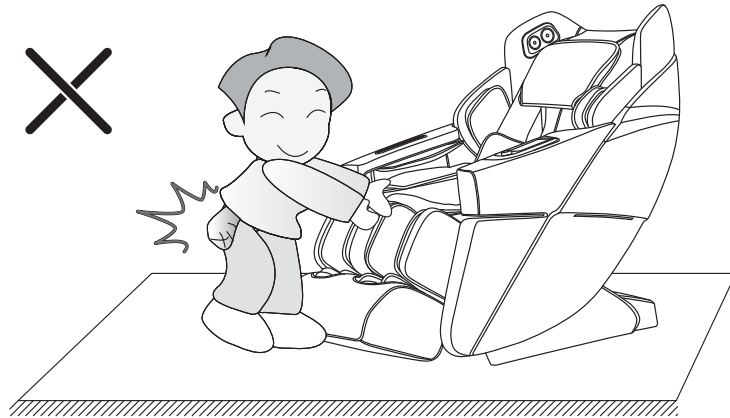

Warning

Do not unplug the power cord, or directly turn off the power switch on the back of the massage chair during massage, in order to avoid any damage to this product or physical injury.

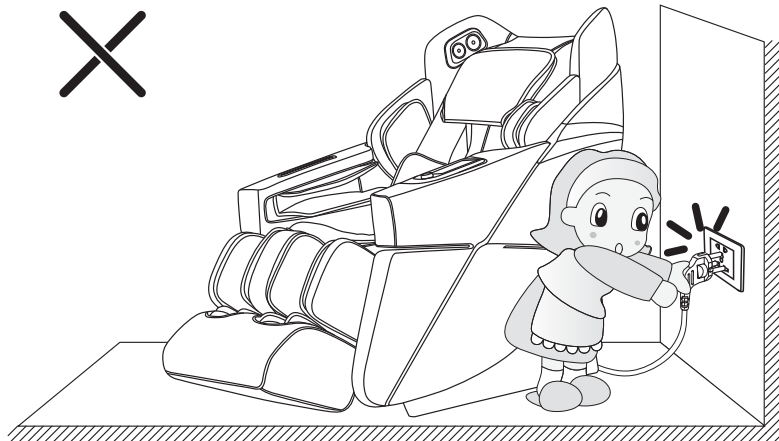

Name of Components

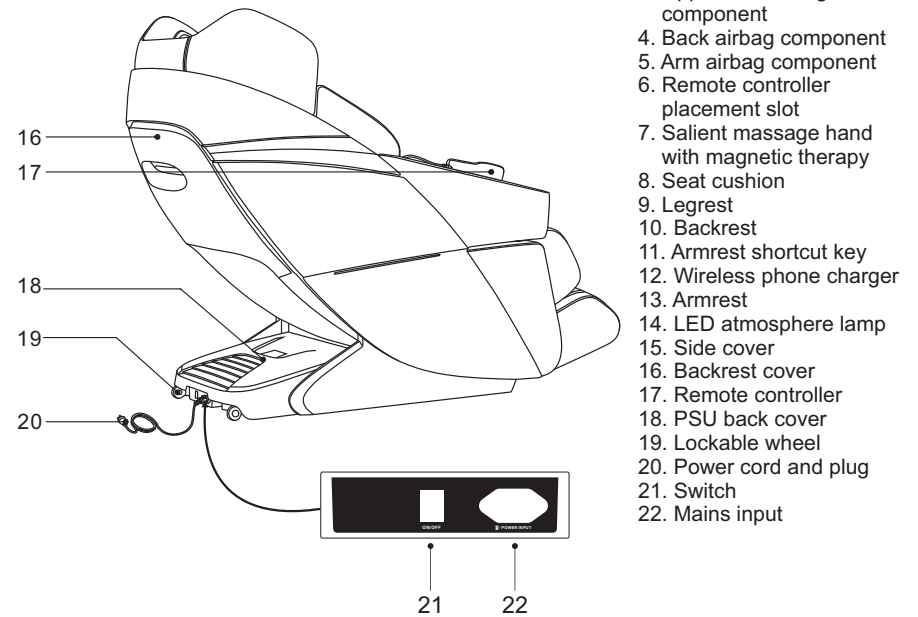
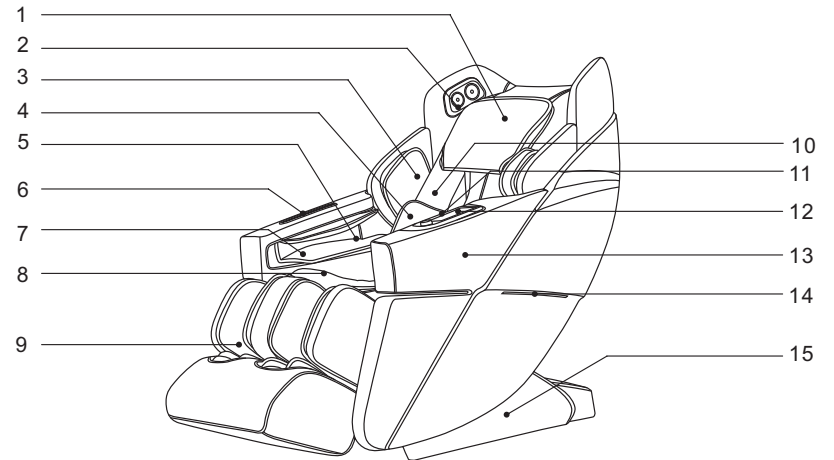

1. Head cushion
2. 3D digital audio
3. Upper arm airbag component
4. Back airbag component
5. Arm airbag component
6. Remote controller placement slot
7. Salient massage hand with magnetic therapy
8. Seat cushion
9. Legrest
10. Backrest
11. Armrest shortcut key
12. Wireless phone charger
13. Armrest
14. LED atmosphere lamp
15. Side cover
16. Backrest cover
17. Remote controller
18. PSU back cover
19. Lockable wheel
20. Power cord and plug
21. Switch
22. Mains input

Function

- This product is designed with a set of intelligent 3D massage manipulators with silent design that can move up and down and extend from front to back.
- It is designed with automatic detection and micro-adjustment functions of the shoulder position, as well as automatic detection function of the human body curve and shiatsu massage points. Therefore, according to the detected human body curve and shiatsu massage points, it can automatically adjust the manipulators to extend from front to back, making the massage more user-friendly and scientific.
- 21 special automatic massage functions are available: fast massage, comfortable massage, relaxing massage, stretching massage, full body massage, neck & shoulder massage, back & waist massage, and full airbag massage, Stress relieving, Energy, Good-night sleep, Joint care, Spine massage, Office regimen, Sport recovery, Neck & shoulder care, Brain refresh, Spine care, Waist care, Legs care and Rejuvenation.
- There are five intelligent memory functions (M1, M2, M3, M4, M5): Remarks on saved massage functions and techniques are available (e.g. father, mother, daughter, son, or none).
- Manual massage range selection is available for the manipulators: including five massage ranges for your option (i.e. full range, local, fixed point, upper back and lower back).
- Manual massage function selection is available for the manipulators: 11 massage techniques are available, including kneading (Seven modes of kneading can be switched cyclically), tapping (Tapping I, Tapping II), simultaneous kneading and tapping, shiatsu (Shiatsu I, Shiatsu II), shoulder lifting, 3D (3D I, 3D II, 3D III, 3D IV), etc.
- Massage adjustment function: 7 massage adjustment functions are available, including 5 speed levels for back massage adjustment, 5 intensity levels for back massage adjustment, 5 range levels for massage adjustment, 5 width levels for massage adjustment, 5 intensity levels for airbag adjustment, 3 speed levels for roller adjustment, 4 time levels for massage adjustment.
- Airbag massage function for the upper body: airbag massage function for the arms (8 built-in air bags), airbag massage function for the upper arms (4 built-in air bags), airbag massage function for the waist (4 built-in air bags), and 5 intensity levels for airbag adjustment.
- Airbag massage function for the lower body: airbag massage function for the legs (6 built-in air bags), airbag massage function for the feet (22 built-in air bags), and 5 intensity levels for airbag adjustment.
- This product is equipped with the back heat treatment function: carbon fiber is used as a far infrared heat source.
- The slide rail technology for the backrest ensures zero space between the backrest and wall, so as to save the space to the greatest extent.
- The backrest guide adopts the curve guide technology, so it completely fits the curve of the human back. The full body can enjoy full massage from the head to the thighs.
- This product is equipped with the intelligent voice control and recognition function (i.e. built-in voice-activated microphone for the left armrest shortcut key).
- The music player system is available. 3D digital audio systems are built into left

Function

- and right upper arms. The Bluetooth function of the smart device can be used to play music wirelessly.
- The wireless charging function of the mobile phone is available at the left armrest shortcut key. The mobile phone can be placed on the fixed wireless charging.
- The left armrest is equipped with an AUTO key, a voice control button for wakeup (it is only effective when the voice control switch in the remote controller is turned on), a back heat treatment switch, a leg UP key, a leg DOWN key, a linkage lying key, a linkage sitting key, a 3D massage intensity knob, ON/OFF (pause) key and other shortcut keys.
- In the air bags for the left and right palms, there are salient massage with magnetic therapy function.
- Leg stretching massage function: the lower legs and backrest can be lifted and lowered for automatic lying, as well as automatic cyclic lying. Meanwhile, the leg air bags and the back manipulator simultaneously cooperate with each other for massage, and the legs can be stretched for massage.
- This product is equipped with the leg kneading massage function: the kneading and airbag squeezing massage functions are provided on the leg rest to relieve the stiffness or tension of the leg muscles caused by standing for a long period of time.
- This product is equipped with the salient scraping massage for the calf: It can relieve fatigue, tightness, and pain of the calf muscles, effectively promote the blood circulation, massage meridians, effectively improve the stiffness or tension of the leg muscles, and relieve local swelling and restore vitality.
- The massage chair is equipped with the independent up/down adjustment function of the leg rest and the backrest, the linkage up/down adjustment function of the backrest, and the zero-gravity automatic lying angle adjustment function.
- The foot roller massage function is available for the feet bottoms. Three sets of rollers roll to massage the roots of the toes; rolling and scraping massage is available for the foot arch; there are three speed levels for adjustment.
- The leg rest is equipped with the adjustment function, so linkage extension and retraction are possible for the feet and legs; when the legs are pulled out with the pedals, the legs will rise (the opposite direction to the feet) together with the stretching of the feet. The stretching length of the feet relies on the length of the user's legs. The extension length of the legs is half of the stretching length of the feet, and the retraction of the feet and legs depends on the spring force.
- The left and right armrests are equipped with LED atmosphere lamps.
- Such functions as shutdown, automatic sitting up, and automatic manipulator resetting are available.
- The product has a remote controller with TFT color screen.
- The head cushion uses the two section foldable design, and you can decide the number of layers upon your own request to reduce the massage intensity of the neck and shoulder. The head cushion can extend to the back to reduce the massage intensity of the back. This is suitable for different users and can be selected freely.

Introduction to the Remote Controller

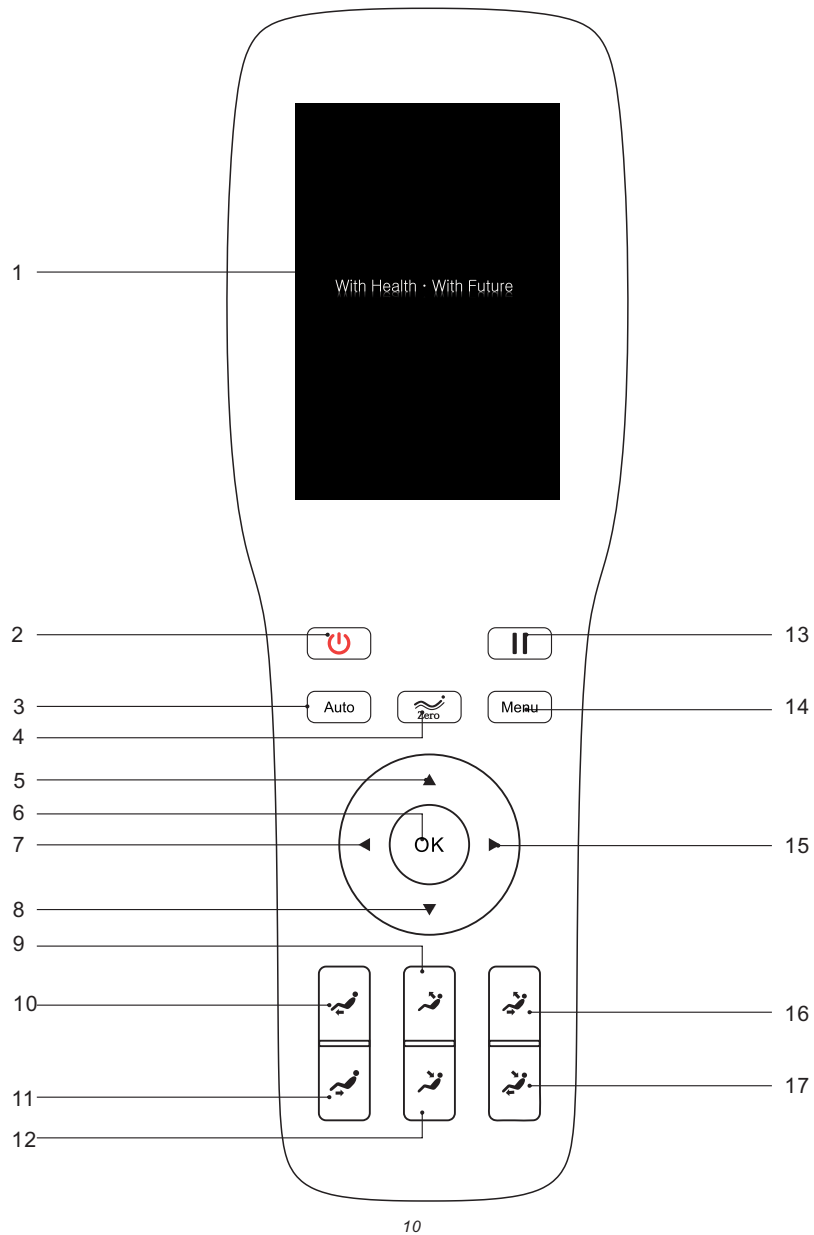

Introduction to the Remote Controller

1. Display:
 - TFT color LCD showing the massage functions in the running state.
2. Switch:
 - Turn on or off the massage.
3. AUTO key:
 - Enter the automatic function mode selection interface. For more information about the functions, refer to Page 16 of the Operation Instructions.
4. Zero-gravity key:
 - Adjust the angle of the massage chair for zero gravity. There are a total of four modes to choose from (i.e. 1st pressing is Level 1; 2nd pressing is Level 2; 3rd pressing is Level 3; and 4th pressing makes the massage chair restore to the original state).
5. Up key:
 - Up navigation key: select an object upward in the menu, or adjust the massage position upward.
6. OK:
 - Confirm the selected massage function for massage.
7. Left button:
 - Left navigation key: return to the previous menu, or select an object leftwards.
8. Down key:
 - Down navigation key: select an object downward in the menu, or adjust the massage position downward.
9. Backrest up button:
 - Adjust the backrest upward according to your own massage needs for the most comfortable massage posture.
10. Legrest Up key:
 - Adjust the legrest upward according to your own massage needs for the most comfortable massage posture.
11. Legrest down key:
 - Adjust the leg rest downward according to your own massage needs for the most comfortable massage posture.
12. Backrest down button:
 - Adjust the backrest downward according to your own massage needs for the most comfortable massage posture.
13. Pause button:
 - Pause all the massage functions currently in service. Press this button again to continue to run all the massage functions before such pause.
14. Menu button:
 - Enter the main menu selection interface. For more information about the functions, refer to Page 15 of the Operation Instructions.
15. Right button:
 - Right navigation key: enter the submenu, or select an object rightwards.
16. Linkage sitting key:
 - According to the required massage angle, simultaneously adjust the linkage sitting function of the backrest and the leg rest for the most comfortable linkage sitting massage posture.
17. Linkage lying key:
 - According to the required massage angle, simultaneously adjust the linkage lying function of the backrest and the leg rest for the most comfortable linkage lying massage posture.

Method of Usage

I. Turn on the power supply of this product:

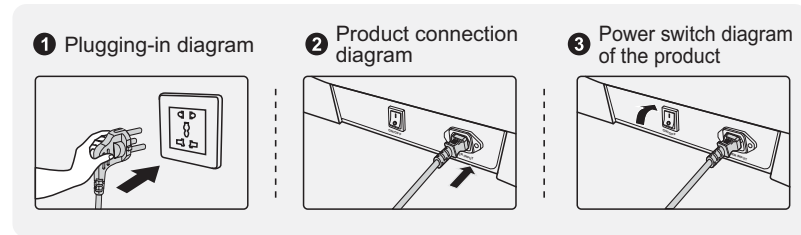

II. Massage Function Control Operation:

1. Standby

· After the massage chair is powered on and turned off, the remote controller is blank in the standby state (i.e. the LED lamp is off) and cannot perform any operation (except the key switch). You can use the armrest shortcut keys to adjust the angle of the backrest and leg rest. You can also use the voice control button for wakeup.



2. Start massage (power switch)

· Press the switch to start massage. Enter the start-up screen. The backrest will maintain the default position, and the leg rest will be slightly raised. Just wait for any one of automatic function programs in the automatic function selection interface to start massage. If no "AUTO" function is selected within 5 minutes, the massage chair will automatically shut down.

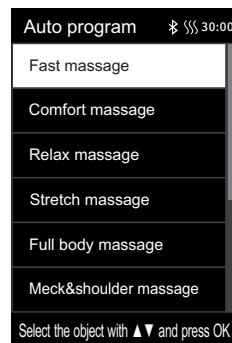

Method of Usage

1) Lying angle adjustment

· After selecting any automatic function, the positions of the backrest and the leg rest will be adjusted to the preset angles.
· After the angle is adjusted, the massage chair will automatically perform the shoulder position and body shape detection. Wait for completion of such detection (alternatively, press "OK" to skip the step).

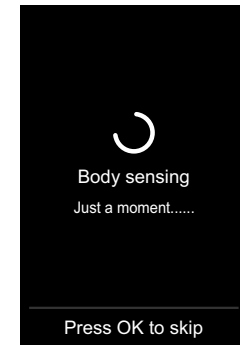
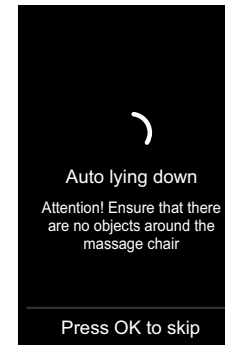

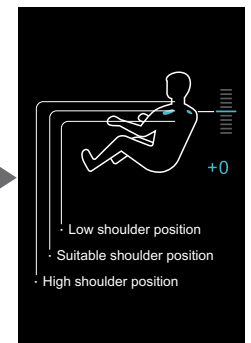
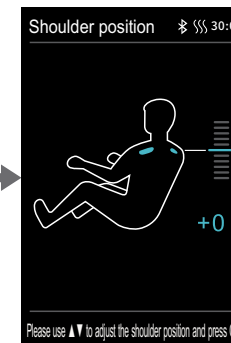
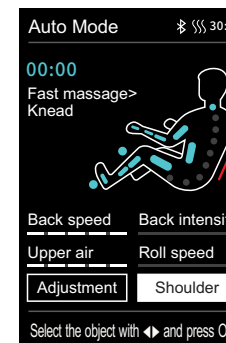

2) Shoulder position adjustment

· After detecting the shoulder position, the buzzer will beep. If there is any difference from the actual shoulder position, adjust it to the appropriate position by pressing the "UP" or "DOWN" key. The shoulder position has 11 adjustable levels. If there is no shoulder position adjustment within 10 seconds, the massage function will start automatically. Press "OK" directly to start massage immediately. If no shoulder position can be detected, massage will be started according to the shoulder height by default. Note: During massage, under the information interface, you can press "Right Button" to select the "Shoulder Adjustment" menu, and press "OK" to enter the shoulder adjustment interface. You can also use "Up Key" or "Down Key" to adjust the shoulder position.



Method of Usage

Button	Description
	Move the massage balls upward to a suitable shoulder position
	Move the massage balls downward to a suitable shoulder position

- If you need to adjust the shoulder position after the massage program is started, you can directly select "Shoulder Position Adjustment" to enter the shoulder position adjustment interface; you can press "Up Key" or "Down Key" to adjust the shoulder position height; you can press "Left Button" to return to the previous menu, or wait for 10 seconds to automatically return to the information interface

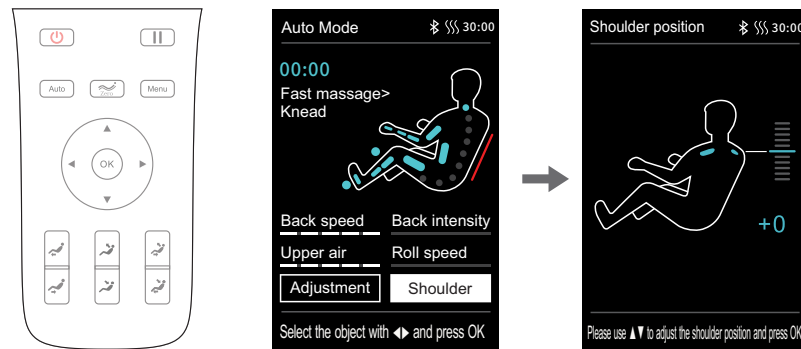

3) Massage position adjustment

- After entering the massage program, if you need to adjust the massage position, you can press the "Menu" button on the remote controller to select "Manual Function" to enter; you can select any one of the manual functions, and then press "Left Button" to return to the information interface (i.e. The information interface will switch to the manual function interface)
- In the manual function interface, if the massage range shows a fixed point or local area, you can directly press "Up Key" or "Down Key" to adjust the manipulator upward and downward
- In the manual function interface, if the massage range displays neither fixed point nor local area, you need to select "Massage Adjustment" to enter, and then select "Massage Range", and a fixed point or local area, and press "Left Button" to return to the information interface. Next, you need to press "Up Key" or "Down Key" to adjust the manipulator upward and downward

Method of Usage

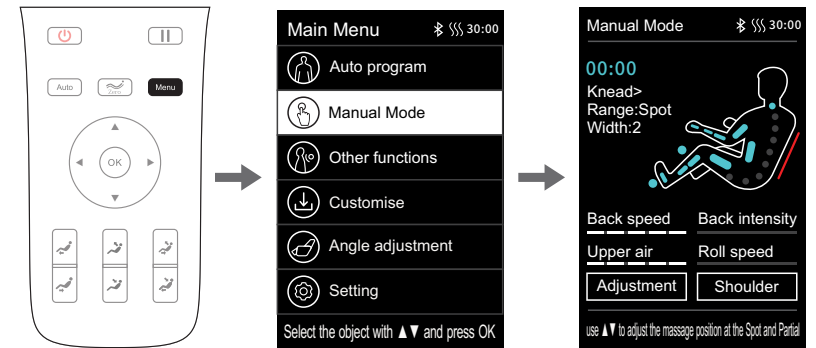

Note: you can't adjust the massage position when it is in auto program.

3.Pause button

- While the massage function is in service, press "Pause" button to temporarily stop all the massage functions; press "Pause" button again to continue the massage function before pause. If the pause time exceeds 20 minutes, all the massage functions will be automatically turned off.

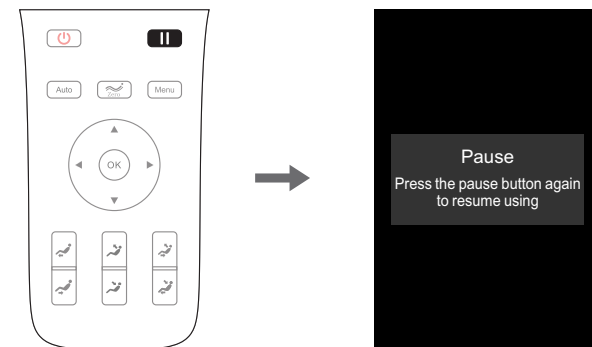

4.Menu button

- Press "Menu Button" to enter the massage function selection interface of the main menu, including automatic, manual, and other functions, intelligent storage, angle adjustment, settings and other function interfaces.
- Enter the menu interface. Press "Up Key" or "Down Key" to select the function. Confirm via "OK" to enter the next level of selection; press "Left Button" to return to the previous menu interface.

Method of Usage

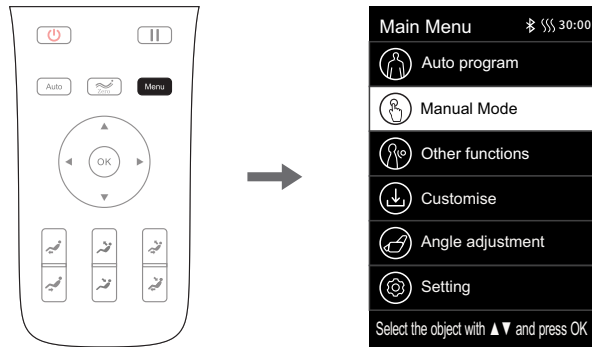

1) Automatic function (main menu - automatic function)

- Press "Menu Button" to enter the main menu interface. Press "Up Key" or "Down Key" to select the automatic functions. Press "OK" (or press "AUTO Key" directly in the information interface) to enter the selection of automatic functions.
- 21 special automatic massage functions are available: fast massage, comfortable massage, relaxing massage, stretching massage, full body massage, neck & shoulder massage, back & waist massage, and full airbag massage, Stress relieving, Energy, Good-night sleep, Joint care, Spine massage, Office regimen, Sport recovery, Neck & shoulder care, Brain refresh, Spine care, Waist care, Legs care and Rejuvenation.
- Enter the automatic function interface. Press "Up Key" or "Down Key" to select any automatic function massage program. It will automatically return to the information interface, which will be displayed as the automatic function information interface.

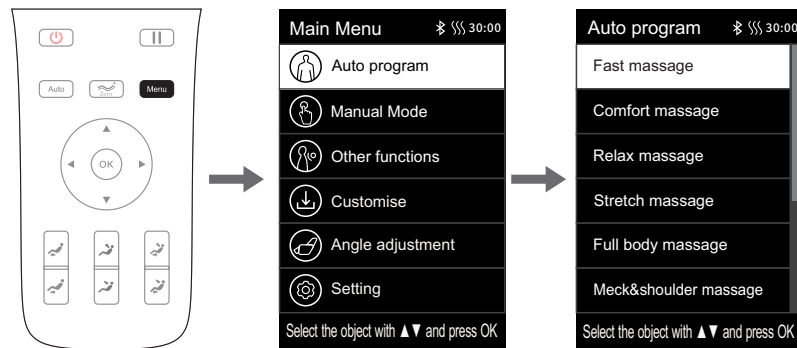

Method of Usage

Function	Description
Fast massage	Experience all the massage effects quickly.
Comfortable massage	The most comfortable massage experience.
Relaxing massage	Gentle and comfortable deep massage to relieve your body fatigue and relax the body.
Stretching massage	Stretch your legs and waist through the leg rest and the backrest to effectively remove fatigue, relieve joint pain and restore vitality.
Full body massage	Deep massage to rejuvenate your body.
Neck & shoulder massage	With the unique massage technique for the neck and shoulder, the effective massage for the cervical spine and scapula can be performed to relieve the neck and shoulder pain and reduce fatigue on the neck and shoulder.
Back & waist massage	Focus on the back and waist massage to relieve the pain on the back and waist.
Full airbag massage	Focus on the full-body airbag massage to achieve full relaxation and deep massage of the body and fully relieve the fatigue and pain from your body.
Stress Relieving	Restore the full body from fatigue and pain; achieve relaxation, improve micro-circulation, and quickly relieve fatigue for the back and limbs.
Energy	After a night of rest, the body can have a rest; the whole body muscles are massaged to quickly wake up the body functions and start a new day of vitality.
Good-night Sleep	Through the massage for the twelve major acupoints for healthcare, it helps the body to adjust balance, quickly improve your sleep and your sleep quality.
Joint Care	Care for the health of all your limbs and joints by pushing, pulling, stretching, and other massage modes.
Neck & shoulder care	With the unique massage technique for the neck and shoulder, the effective massage for the cervical spine and scapula can be performed to relieve the neck and shoulder pain and improve the blood supply to the brain.

Method of Usage

Spine Massage	Improve humpback and chest down; massage for each vertebra; care for the spine health; and improve the protrusion of intervertebral disc.
Office Regimen	For sitting in the office for a long period of time, this function can increase physical exercise by massage and improve the body functions.
Sport Recovery	Make you quickly recover from physical fatigue after exercise.
Brain Refresh	Relieve the neck and shoulder pain; promote the blood supply to the brain by massaging the YUZHEN and DAZHU points.
Spine Care	Care for the health of spine and perform improvements for the lack of exercise.
Waist Care	Focus on improving the health of the lumbar spine and alleviating the stiffness of the waist muscles.
Legs Care	Quickly relieve the pain of the lower extremities and the muscle fatigue.
Rejuvenation	Improve the quality of nap and work efficiency.

Note: The automatic functions in service already selected will be displayed in the massage function status bar.

2) Manual function (main menu - manual function)

- Press "Menu Button" to enter the main menu interface. Press "Up Key" or "Down Key" to select the manual function, and press "OK" to enter the manual function interface.
- 11 manual massage techniques/functions: OFF, kneading, Tapping I, Tapping II, simultaneous kneading and tapping, Shiatsu I, Shiatsu II, shoulder lifting, 3D I, 3D II, 3D III, 3D IV, etc.
- After entering the manual function interface, press "Up Key" or "Down Key" to select the required manual massage technique. Press "OK" to confirm (There are seven modes of kneading, press the "confirm key" to switch cyclically). After selecting the technique, you will not automatically return to the information interface. Press "Left Button" to return to the previous interface. After returning to the information interface, you will find that you have entered the information interface of the manual function.

Method of Usage

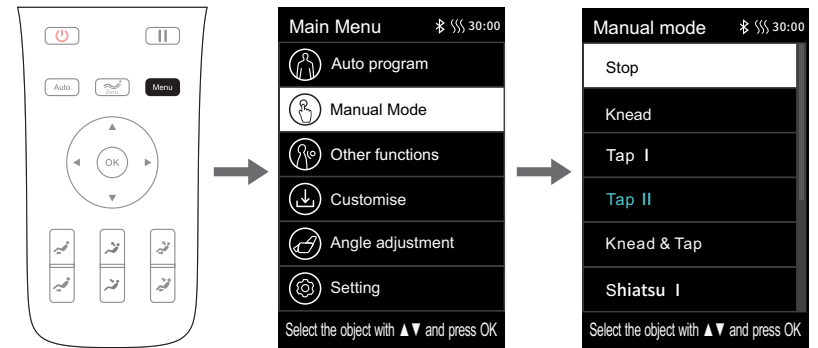

Function	Description	
Kneading	Speed	<ul style="list-style-type: none"> · 5 speed levels adjustable · 5 width levels adjustable
Tapping	Speed, width	
Simultaneous kneading and tapping	Speed	
Shiatsu	Speed, width	
Shoulder lifting	Speed	
3D	Speed, width	

Note: In 3D massage technique mode, the width of 3D I and 3D II cannot be adjusted; the width of 3D III and 3D IV can be adjusted.

2) Other functions (main menu key - other functions)

- Press "Menu Button" to enter the main menu interface. Press "Up Key" or "Down Key" to select other function icons. Press "OK" to enter another function interfaces.
- Other functions include: airbag massage for the upper body, airbag massage for the lower body, back heating, leg kneading and other massage functions.
- After entering another function interface, press "Up Key" or "Down Key" to select the massage function. After selecting any one of the functions, use "Right Button" to enable or disable the function. Then press "OK" to confirm. Press "Left Button" to return to the previous menu interface.

Method of Usage

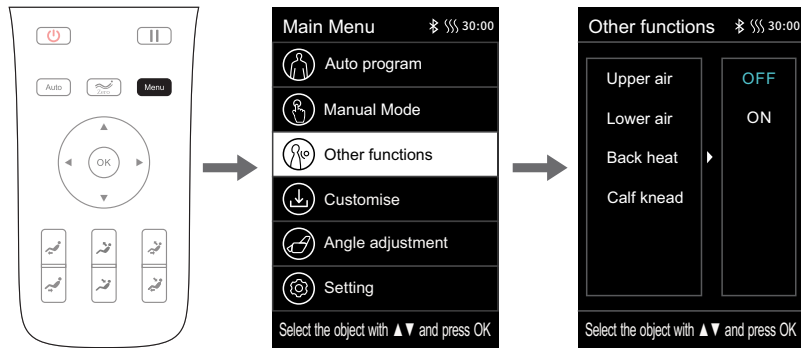

01) Other functions - airbag massage for the upper body

- Airbag massage for the upper body: including airbag massage for the upper arms pressure, airbag massage for the arms, airbag massage for the waist, and other airbag massage functions.
- Enter another function interface. Press "Up Key" or "Down Key" to select the airbag massage function for the upper body. Use "Right Button" to enable or disable the airbag massage function for the upper body. Then press "OK" to confirm. Press "Left Button" to return to the previous menu interface.

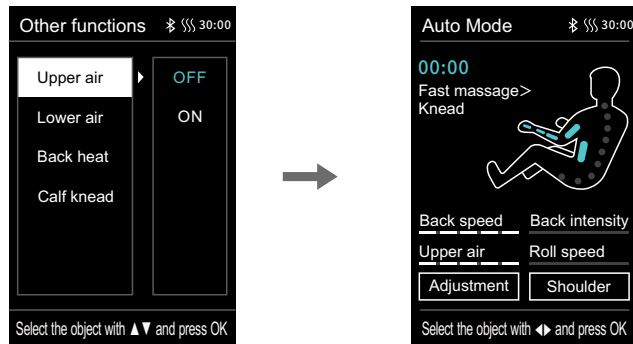

02) Other functions - airbag massage for the lower body

- Airbag massage for the lower body: including airbag massage functions for the legs, feet, etc.
- Enter another function interface. Press "Up Key" or "Down Key" to select the airbag massage function for the lower body. Use "Right Button" to enable or disable the airbag massage function for the lower body. Then press "OK" to confirm. Press "Left Button" to return to the previous menu interface.

Method of Usage

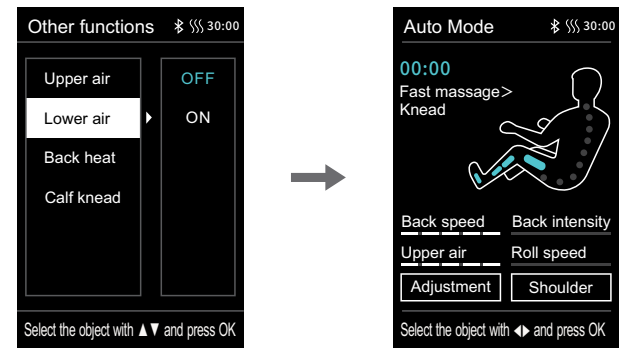

03) Other functions - back heating

- Back heating: enable or disable the back heating function; the back will become warmer after such heating for 3min.
- Enter another function interface. Press "Up Key" or "Down Key" to select the back heating function. Use "Right Button" to enable or disable such function. Then press "OK" to confirm. Press "Left Button" to return to the previous menu interface.

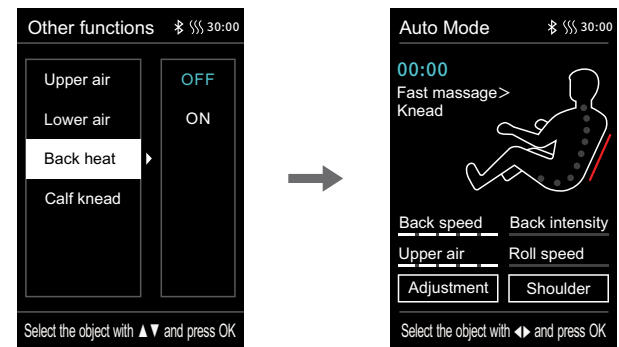

04) Other functions - leg kneading

- Leg kneading: enable or disable the leg kneading function.
- Enter another function interface. Press "Up Key" or "Down Key" to select the leg kneading function. Use "Right Button" to enable or disable such function. Then press "OK" to confirm. Press "Left Button" to return to the previous menu interface.

Method of Usage

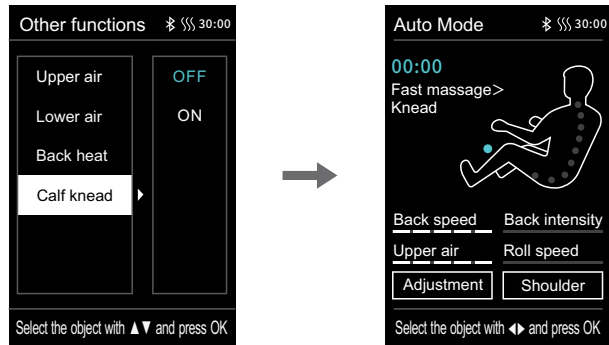

4) Intelligent storage (main menu - intelligent storage)

- Press the "Menu Button" to enter the menu interface. Press "Up Key" or "Down Key" to select the intelligent storage icon. Press "OK" to enter the intelligent storage interface, including: intelligent storage call, intelligent storage saving, cancellation and other storage functions.
 - Intelligent storage call includes: M1, M2, M3, M4, and M5.
 - Intelligent storage saving include: M1, M2, M3, M4, and M5.
 - Call: Call the stored massage mode, massage technique, airbag mode and intensity under the current running status, the positions and angles of the leg rest and the backrest, and other massage functions.
 - Storage: Store the massage mode, massage technique, airbag mode and intensity under the current running status, the positions and angles of the leg rest and the backrest, and other massage functions.
 - Cancellation is the exit option.
- Note: When saving the massage method, you can comment on the saved massage function and method (e.g. father, mother, son, daughter, or none).

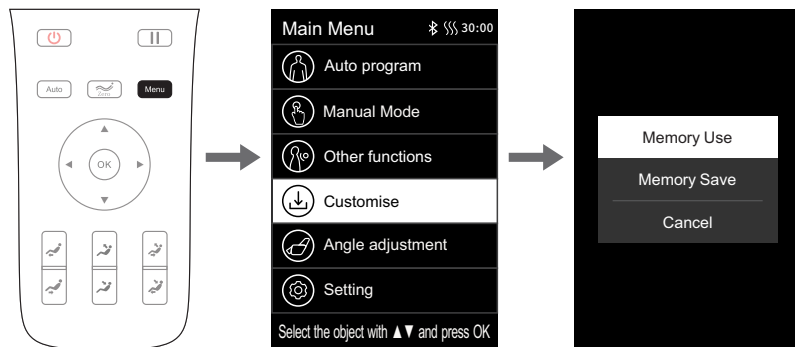

Method of Usage

01) Intelligent storage - save or cancel

- After entering the intelligent storage (saving) interface, press "Up Key" or "Down Key" to select the massage function to be stored. Press "OK" to save or cancel.
- Enter the intelligent storage (saving) interface. Press "Up Key" or "Down Key" to select any one of the M1-M5 saving procedures. Select "OK" to confirm, and comment on the saved massage function; press "Left Button" to return to the previous menu interface.

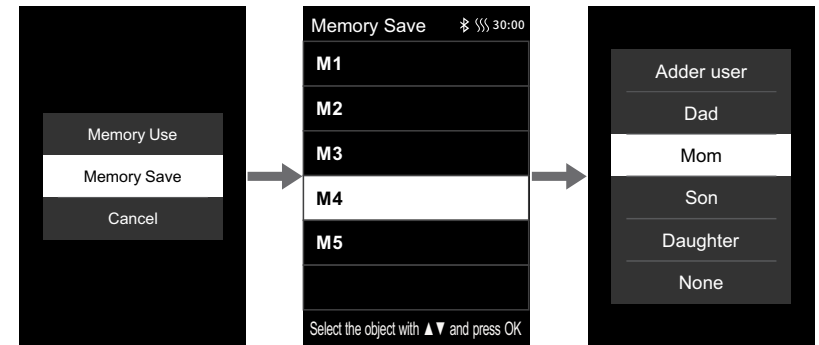

Note: Note: You can comment on the saved massage functions and techniques (e.g. father, mother, daughter, son, or none).

02) Intelligent storage - call or cancel

- After entering the intelligent storage (call) interface, press "Up Key" or "Down Key" to select the massage function to be called. Press "OK" to enter the call or cancellation interface.
- Enter the intelligent storage (call) interface. Press "Up Key" or "Down Key" to select any one of the M1-M5 call procedures required to call the saved massage program; press "Left Button" to return to the previous menu interface.

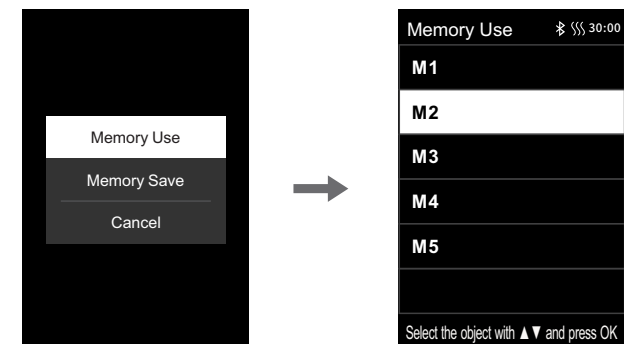

Method of Usage

5) Angle adjustment (main menu-angle adjustment)

- Press "Menu Button" to enter the main menu interface. Press "Up Key" or "Down Key" to select the angle adjustment icon. Press "OK" to enter the angle adjustment interface.
- Angle adjustment includes: full body angle, backrest angle, leg rest angle, zero gravity and other adjustment functions.
- After entering the angle adjustment interface, press "Up Key" or "Down Key" to select the desired angle adjustment function. After selecting any angle, press "OK" to confirm the selected angle adjustment. Press "Left Button" to return to the previous menu interface.

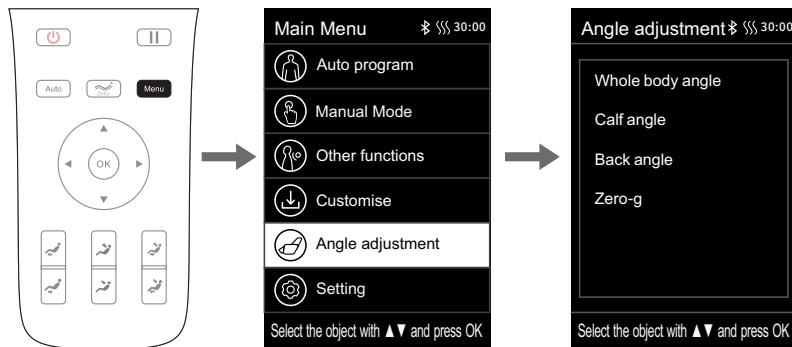

01) Angle adjustment - angle for the whole body

- Angle adjustment for the whole body: adjust the angles of the backrest and the leg rest at the same time.
- Enter the angle adjustment interface. Press "Up Key" or "Down Key" to select the angle function for the whole body. Then press "Up Key" or "Down Key" to adjust the angle for the whole body to the desired angle; press "Left Button" to return to the previous menu interface.

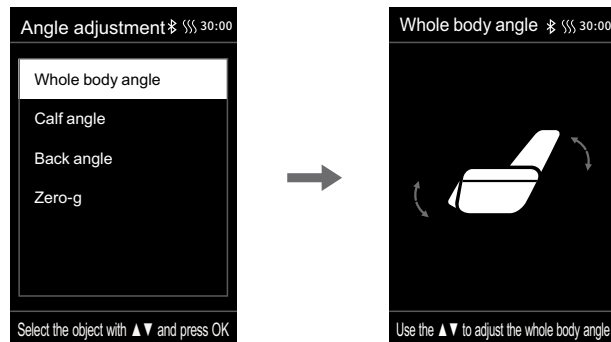

Method of Usage

02) Angle adjustment - leg angle

- Legrest angle adjustment: adjust the legrest upward and downward.
- Enter the angle adjustment interface. Press "Up Key" or "Down Key" to select the leg rest angle function. Then press "Up Key" or "Down Key" to adjust the legrest angle to the desired massage angle; press "Left Button" to return to the previous menu interface.

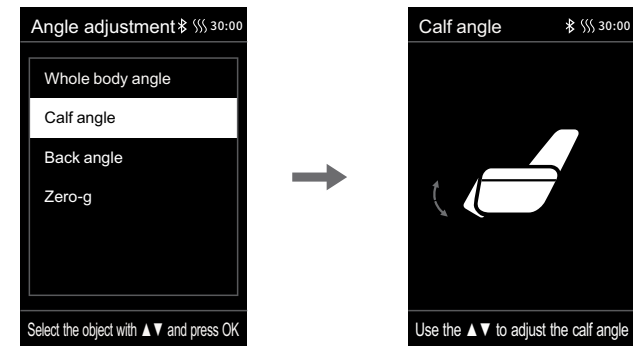

03) Angle adjustment - backrest angle

- Backrest angle adjustment: lying adjustment of the backrest.
- Enter the angle adjustment interface. Press "Up Key" or "Down Key" to select the backrest angle function. Then press "Up Key" or "Down Key" to adjust the backrest lying angle to the desired massage angle; press "Left Button" to return to the previous menu interface.

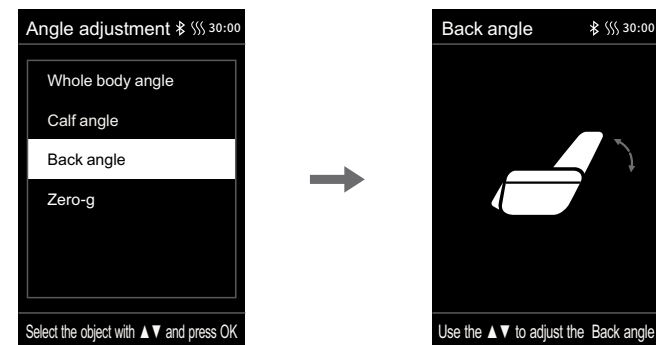

Method of Usage

04) Angle adjustment - zero-gravity

- Angle adjustment for zero gravity: There are three levels of angle adjustment for zero gravity and zero gravity OFF function. A total of four modes can be selected.
- Enter the angle adjustment interface. Press "Up Key" or "Down Key" to select the zero gravity function; press "OK" to enter the zero gravity interface, and then press "Up Key" or "Down Key" to select OFF, any of Level 1, Level 2 or Level 3 for the zero gravity angle. Then press "OK" to confirm; press "Left Button" to return to the previous menu interface.



6) Settings (Main Menu-Settings)

- Press "Menu Button" to enter the main menu interface. Press "Up Key" or "Down Key" to select the settings icon. Press "OK" to enter the settings interface.
- Settings include: language settings, Bluetooth settings, intelligent voice control, Equipment ID and other settings functions.
- After entering the settings interface, press the "Up Key" or "Down Key" to select the desired settings function. Select any one of the settings functions, and then press "Right Button" to set the selected settings function. Press the "OK" to confirm; press "Left Button" to return to the previous menu interface.

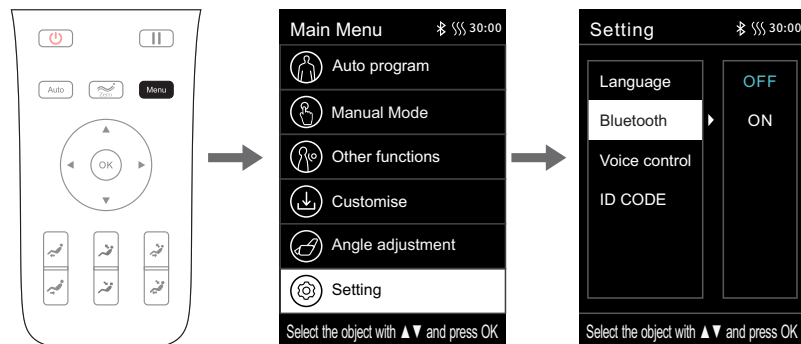

Method of Usage

01) Settings - language settings

- Voice settings: including Chinese and English (the function has memory, that is, after such selection, power-off and restart, it will be the last selected state).
- Enter the settings interface. Press "Up Key" or "Down Key" to select the language settings. Press "Right Button" to enter the language settings. Press "OK" to select the required Simplified Chinese or English; press "Left Button" to return to the previous menu interface.

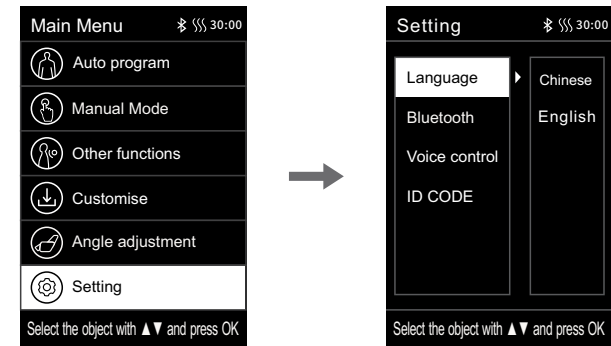

02) Settings - Bluetooth settings

- Bluetooth settings (OFF by default): After the Bluetooth function of the massage chair is enabled, the Bluetooth-enabled audio source device (e.g. mobile phone, MID tablet) can be connected with the Bluetooth module of the massage chair, and the music played by the audio source device can be wirelessly transmitted to the audio system of the massage chair via Bluetooth for music playback.
- Enter the settings interface. Press "Up Key" or "Down Key" to select the Bluetooth settings. Press "Right Button" to enter the Bluetooth ON/OFF interface. Press "OK" to select the required ON or OFF; press "Left Button" to return to the previous menu interface.

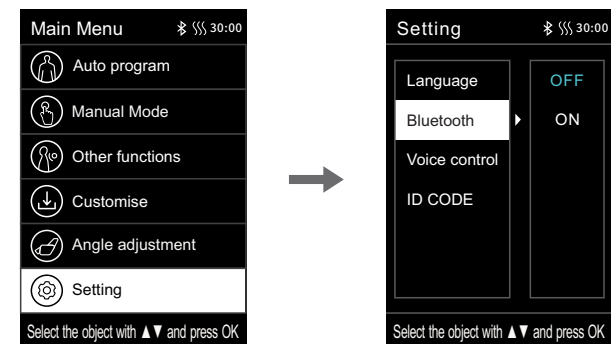

Method of Usage

03) Intelligent Voice Control

- Intelligent voice control: enable or disable the intelligent voice control function (the function has a memory, that is, after such selection, power-off and restart, it will be the last selected state); Note: When the intelligent voice control is disabled, voice wakeup cannot be performed.
- Enter the settings interface. Press "Up Key" or "Down Key" to select the intelligent voice control function. Press "Right Button" to enter the intelligent voice control function settings. Press "OK" to select the required ON or OFF; press "Left Button" to return to the previous menu interface.

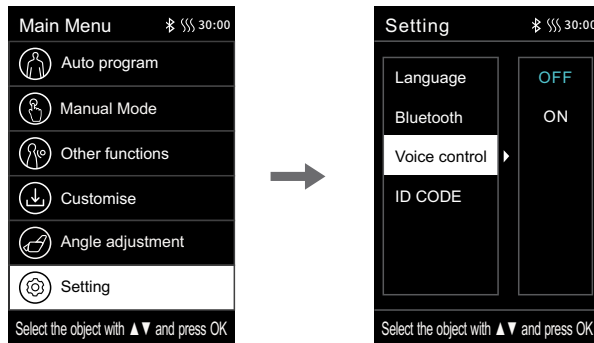

04) Equipment ID

- Equipment ID: Display the current device ID number.
- Enter the settings interface. Press "Up Key" or "Down Key" to select the equipment ID and check the equipment number of the current device.

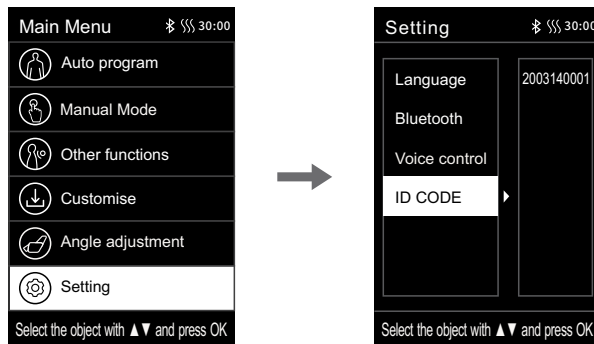

Method of Usage

7) Message adjustment

- In the state of the information interface, press "Left Button" or "Right Button" to select the message adjustment button, and press "OK" to enter the message adjustment interface.
- Message adjustment includes: 7 message adjustment functions can be selected, including back massage speed, back massage intensity, massage range, massage width, airbag intensity, roller speed, and massage time.
- After entering the message adjustment interface, press "Up Key" or "Down Key" to select the desired message adjustment function. After selecting any one of the desired message adjustment functions, use "Right Button" to enter the message level selection interface. Then press "OK" to confirm the selected level. Press "Left Button" to return to the previous menu interface.

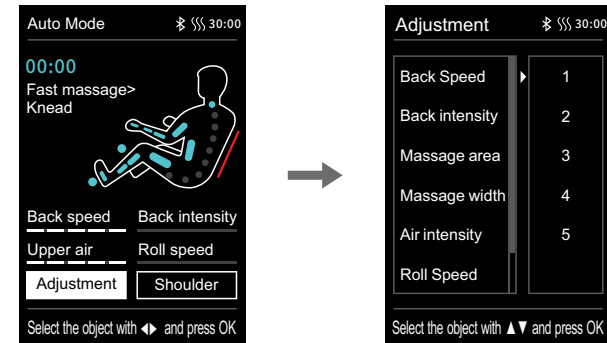

Function	Description
Back massage speed	5 speed levels adjustable
Back massage intensity	5 intensity levels adjustable
Massage range	There are 5 modes for your choice: fixed point, local area, full back, upper back, and lower back
Massage width	5 width levels adjustable
Airbag intensity	5 intensity levels adjustable
Roller speed	Choose from 4 modes including OFF and Level 1-3
Massage time	Choose from 4 modes: +10min, +5min, -5min, -10min

Method of Usage

Note:

- According to the remaining massage time, when the displayed time is not enough for the addition and subtraction of a certain time, the operation will not be displayed (the upper limit of the time display is 40 minutes). For example: If the display time of the remote controller is 39 minutes, the massage time adjustment range will be: -5min, -10min (+10min or +5min cannot be displayed).
- The adjustment of airbag intensity can only be used when the airbag function or the automatic function is enabled (for more information about how to enable the airbag function, refer to Page 18 of the Operation Instructions).

5.Zero-gravity key



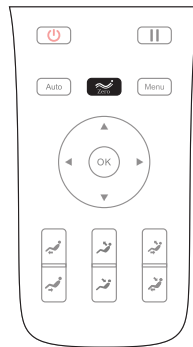



- Press "Zero-gravity Key" to adjust the position of zero gravity. You can choose different angle positions for zero gravity according to your own needs (i.e. 1st pressing is Level 1; 2nd pressing is Level 2; 3rd pressing is Level 3; and 4th pressing makes the massage chair restore to the original state).



Button	Description
	Zero-gravity Key: Once it is pressed, the positions of the leg rest and the backrest can be automatically adjusted to the positions for zero gravity. There are three zero-gravity modes and the lying OFF mode, which can be switched.

Method of Usage

6.Lying angle adjustment button

Button	Description
	Leg rest up button: Hold down the button to make the leg rest rise slowly. Release it to stop such action.
	Leg rest down button: Hold down the button to make the leg rest move downward slowly. Release it to stop such action.
	Backrest up button: Hold down the button to make the backrest rise slowly. Release it to stop such action.
	Backrest down button: Hold down the button to make the backrest move downward slowly. Release it to stop such action.
	Linkage sitting key: By holding down this key, the backrest will rise slowly and the leg rest will move downward slowly; by releasing it, such UP/DOWN action of the backrest and the leg rest will be stopped.
	Linkage lying key: By holding down this key, the backrest will move downward slowly and the leg rest will rise slowly; by releasing it, such DOWN/UP action of the backrest and the Leg rest will be stopped.





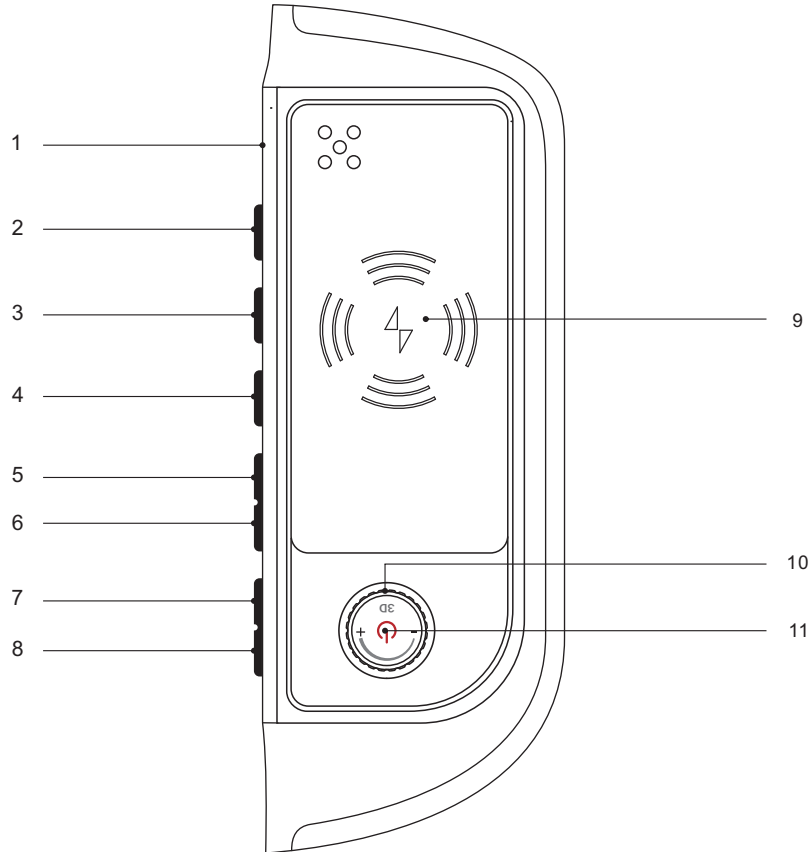



Method of Usage

III.Introduction to Armrest Shortcut Keys



1. Voice control microphone: Built-in voice control microphone.
2. AUTO key: Press it to enable the automatic massage function.
3. Voice control and wake-up button: Short press to enable the voice control function, long press 3 seconds to turn on or off the voice control function.
4. Heat treatment key: Click the key to enable or disable the heat treatment function.
5. Leg rest down button: Adjust the leg rest downward.
6. Leg rest up button: Adjust the leg rest upward.
7. Linkage sitting key: Adjust the linkage sitting angle.
8. Linkage lying key: Adjust the linkage lying angle.
9. Wireless phone charger: wireless charging of mobile phone
10. 3D intensity knob: adjust the massage intensity of 3D manipulator.
11. Switch: Hold it down for 2 seconds to turn on or off the massage chair.

Method of Usage

Button	Description
	Power button: Short press this button to pause the operation; if it is hold down for 3 seconds, power will be ON/OFF. If the pause time during massage exceeds 20 minutes, all the massage functions will be automatically turned off.
	3D intensity knob: adjust the massage intensity of 3D manipulator (counterclockwise indicates "-", while clockwise indicates "+"). The intensity range is Level 1-5.
	Linkage sitting key: By holding down this key, the backrest will rise slowly and the leg rest will move downward slowly; by releasing it, such UP/DOWN action of the backrest and the leg rest will be stopped.
	Linkage lying key: By holding down this key, the backrest will move downward slowly and the leg rest will rise slowly; by releasing it, such DOWN/UP action of the backrest and the leg rest will be stopped.
	Leg rest up button: Hold down the button to make the leg rest rise slowly. Release it to stop such action.
	Leg rest down button: Hold down the button to make the leg rest move downward slowly. Release it to stop such action.
	Heat treatment key: Click the key to enable or disable the heat treatment function.
	Voice-control wake-up button: press this button to wake up the voice control function and press for 3 seconds to turn the function on or off. if no valid voice entry is recognized within 6 seconds, the voice function is automatically turned off (this button only works after The voice control function turned on
	Automatic mode key: Press it to switch among those automatic massage functions.

Method of Usage

IV. Voice Control Mode

- When the massage chair is turned on or in standby mode, the sound "Hi Alice" or "Hey Alice" will be produced to enable the voice control function.
- Long press 3 seconds to turn on or off the voice control function.
- After such function is enabled successfully, the massage chair will reply "I am here" At this moment, once a corresponding voice control entry to be implemented is given within six seconds, the corresponding voice control function can be performed after a reply is received from the massage chair; if no correct voice control entry is given within six seconds, the voice control function automatically will be off automatically and needs to be enabled again.
- Note: When waking up the voice control function, please use English, the speech rate is moderate, Voice commands should be follow up the Voice entry.

VOICE CONTROL ENTER

Press at least 3 second "🗣️" button on the armrest (on/off Voice Control mode) . Make sure the device is on Voice Control mode. Call "Hi Alice" or "Hey Alice" before the following Commands:

No.	Voice control entry	Answer entry
1	Massage on	Answer: Ok, massage on
2	Massage close	Answer: Ok, massage close
3	Comfort Massage	Answer: Ok, comfort massage
4	Relax massage	Answer: Ok, relax massage
5	Full body massage	Answer: Ok, full body massage
6	Neck massage	Answer: Ok, neck and shoulder massage
7	Back and waist massage	Answer: Ok, back and waist massage
8	Stretch massage	Answer: Ok, stretch massage
9	Open the air pressure	Answer: Ok, open the air pressure
10	Close the air pressure	Answer: Ok, close the air pressure
11	Up the seat position	Answer: Ok, up the seat position
12	Down the seat position	Answer: OK, down the seat position
13	Change the other mode	Answer: OK, change the other mode
14	Go little down	Answer: Ok, go little down
15	Go little up	Answer: Ok, go little up

Note: commands 14 and 15 can only be used after command 13.

Method of Usage

V. Operation Instructions for Bluetooth Speaker Play

1. Enter the smart device main menu. Open "Settings" and select the "Bluetooth" option. Open "Bluetooth", and Bluetooth will automatically "Search for a New Bluetooth Device".
2. The smart device will search for the corresponding Bluetooth model (e.g. IMCM-XXXX). Click the "Match" button. If you are asked whether to match with the device, you just select "Match" to complete matching.
3. Turn on "Music Player" in the smart device and select the song to play.

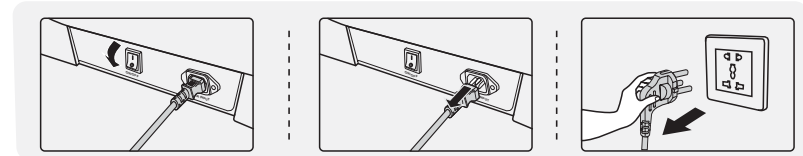

- 1 Power Shut-off Diagram of the Product
- 2 Disconnection Diagram
- 3 Unplugging Diagram

VI. Turn off the power and stop massage

- If the power button is pressed during massage, it will stop all the massage functions immediately, and the backrest, the legrest and massage chair manipulators will go back to the default positions. When the preset massage time is up, all the massage functions will be OFF. The backrest and the legrest will not go back to the default positions.
- Shut off the power supply of this product, as shown in the attached figure (Power Shut-off Diagram of the Product).

VII. Installation Instructions for Armrests

1. Unpack the two packages. Lift out the massage chair and armrest components. Carefully check the accessories and appearance for any damage. Then assemble them with a Phillips screwdriver. Then find the supplied power cord and remote controller from the package. Firstly, insert the remote controller into the front socket on the right side of the massage chair and tighten it (Figure 1); then plug in the power cord, and turn on the switch to power on. At this moment, the massage chair will start the automatic recovery action. After it is changed from the lying and packing state to the standing standby state, unplug its PUS for assembly.
2. Raise the rear end of the armrest, respectively insert the plug and trachea corresponding with the same mark on the rear end of the armrest with the connecting plug and trachea at the back of the backrest, and the match should be in place and firm (Figure 2).

Method of Usage

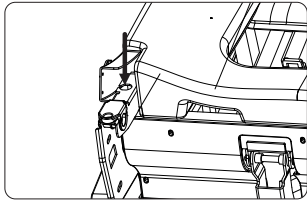

Figure 1

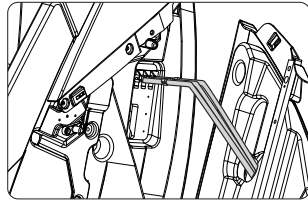

Figure 2

3. Hold the armrest with both bands and insert the middle hook of the armrest into the massage chair frame (Figure 3).
4. Align the limit hole of the armrest assembly with the wire inserted with the limit post of the backrest and insert the armrest (Figure 4).

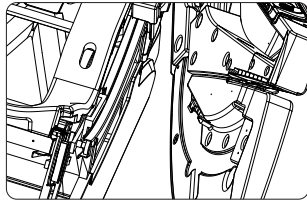

Figure 3

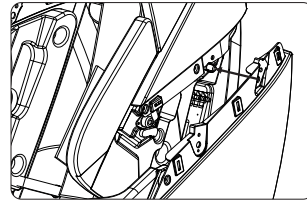

Figure 4

5. Fix the back end of the armrest with two M6 screws (Figure 5).
6. Fix the front end of the armrest with two M6 screws which has inserted the front end hook of the armrest into the front end square opening of the massage frame in the second step (Figure 6).

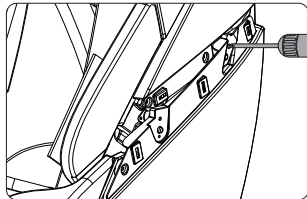

Figure 5

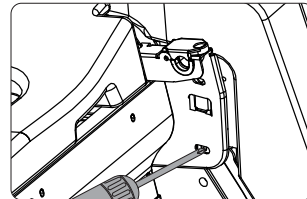

Figure 6

7. Align the buckle on decorations with the corresponding buckle seat of the armrest and tighten it (Figure 7).

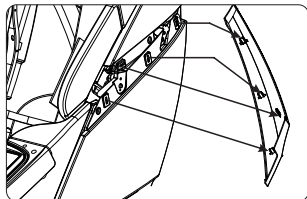
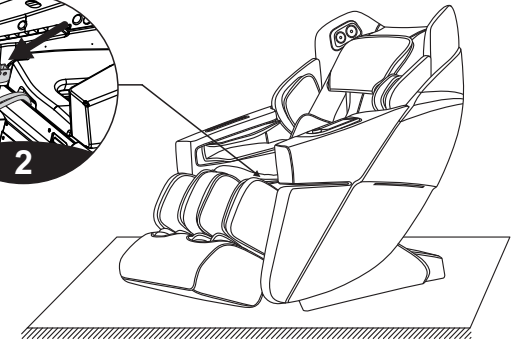
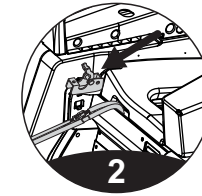
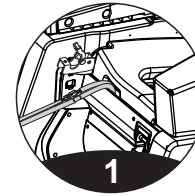

Figure 7

Method of Usage

VIII. Installation Instructions for Legrest

- After connecting the wires and the air hose between the legrest and the massage chair, remove the cable ties and insert the connecting part into the seat (Figure 1).
- Place the round tubes on the left and right sides of the legrest onto the legrest support (Figure 2)



- Next, turn the legrest fixing cover over to cover the round tubes on both sides of the legrest (Figure 3).
- Fasten the legrest to the massage chair with two M5 screws (one on each side). Check whether there is any abnormality during turning up and down, or any tube, cable or wire is folded. If everything is OK, the legrest is installed (Figure 4).

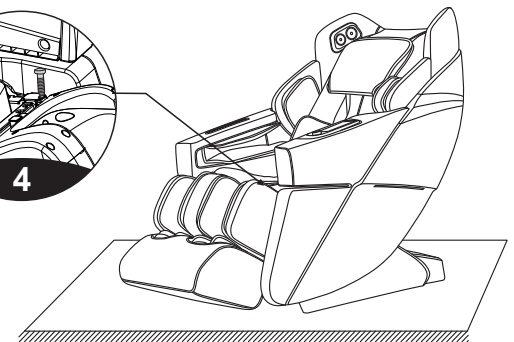
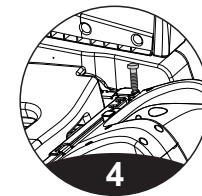
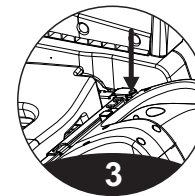

Method of Usage

IX. Instructions for Removal and Use of Head Cushion and Backrest

- The use of the head cushion can reduce the intensity of kneading massage on the neck and shoulders. You can decide whether to use the head cushion according to your own needs (the head cushion is recommended). The backrest and the back cushion are connected by a zipper (1). The head cushion and the backrest are connected by a hook-and-loop fastener (2).

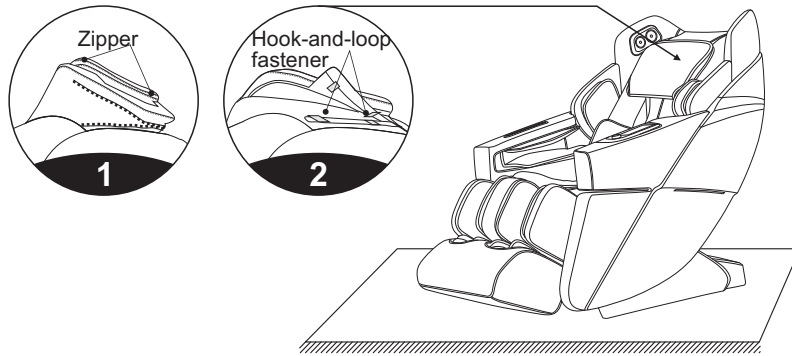

X. Floor Protection

- The prolonged heavy pressure on the massage chair may cause scratches on the floor. Thus, put a carpet or cushion on the floor where the massage chair is placed to avoid this damage.

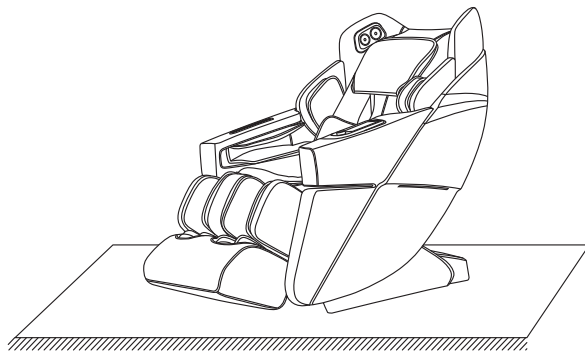

Note: Do not move the massage chair with its wheels on the rough ground or in a narrow space. At least two persons are required to lift it. During lifting, take the legrest sealing plate and backrest cover grooves as the acting points. (Do not lift the armrest directly.)

Method of Usage

XI. Instruction for Movement

- When moving the massage chair, make sure that all the wires are pulled out of the massage chair surface; two persons must work together to move the massage chair. There should be one person respectively in front of and behind the massage chair. The person in front of the massage chair should lift it, while the person behind it should push it downward. When the center of gravity of the massage chair is completely on the base wheels, you can push the massage chair forward to a suitable position and then gently restore it to the normal angle. (Note: During movement, you must turn off the power switch first and then unplug the power cord and the remote controller connection wire.)

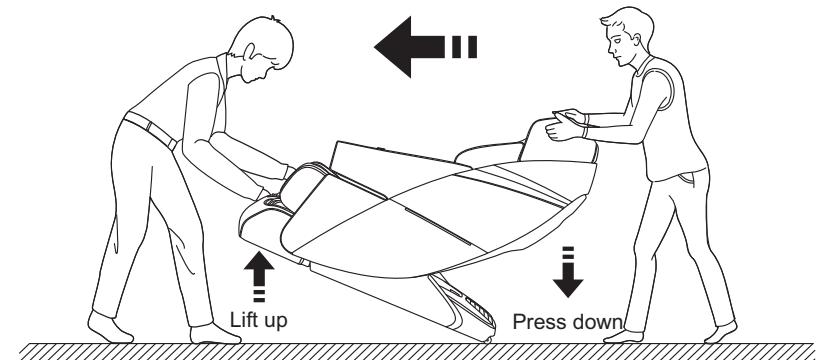

Warning : The rear moving wheels of the massage chair are only suitable for short-distance and slow movement. For long-distance transportation, please use other auxiliary moving tools to move this massage chair!

Product Specification

Model: AD-Allure
Name: Massage Chair
Rated voltage: 110-120V~ 60Hz
Rated power:150W
Rated time: 20min
Safety structure: Class I

Material description: PVC, PA, steel parts, electric and electron components

MATERIAL	PU	LEATHER	CLOTH	WOOD