



*Body Worn Camera*  
**USER MANUAL**

# Preface

Welcome to the world of Hytera and thank you for purchasing this product. To derive optimum performance from the product, please carefully read this manual before use.

This manual is applicable to the following product:

[VM780 4G Body Worn Camera \(MPTT\)](#)

## Icon Conventions

The following icons are available through this manual:

 **Note:** Indicates references that can further describe the related topics.

 **Caution:** Indicates situations that could cause data loss or equipment damage.

## Key Operation

**Long press:** To keep pressing a key for two seconds.

**Press:** To press a key and release it immediately.

**Press and hold:** To press a key and keep holding it down.

## Copyright Information

Hytera is the trademark or registered trademark of Hytera Communications Corporation Limited (the Company) in PRC and/or other countries or areas. The Company retains the ownership of its trademarks and product names. All other trademarks and/or product names that may be used in this manual are properties of their respective owners.

The product described in this manual may include the Company's computer programs stored in memory or other media. Laws in PRC and/or other countries or areas protect the exclusive rights of the Company with respect to its computer programs. The purchase of this product shall not be deemed to grant, either directly or by implication, any rights to the purchaser regarding the Company's computer programs. The Company's computer programs may not be copied, modified, distributed, decompiled, or reverse-engineered in any manner without the prior written consent of the Company.

## Disclaimer

The Company endeavors to achieve the accuracy and completeness of this manual, but no warranty of accuracy or reliability is given. All the specifications and designs are subject to change without notice due to continuous technological development. No part of this manual may be copied, modified, translated, or distributed in any manner without the prior written consent of the Company.

We do not guarantee, for any particular purpose, the accuracy, validity, timeliness, legitimacy or completeness of the third-party products and contents involved in this manual.

If you have any suggestions or would like to receive more information, please visit our website at:

<http://www.hytera.com>.

## EU Regulatory Conformance

As certified by the qualified laboratory, the product is in compliance with the essential requirements and other relevant provisions of the following directives:

- 2006/66/EC
- 2011/65/EU
- 2012/19/EU
- 2014/53/EU

Please note that the above information is applicable to EU countries only.

# 1. Packing List

Please unpack carefully and check that all items listed below are received. If any item is missing or damaged, please contact your dealer.

Item	Qty.	Item	Qty.
Body Worn Camera	1	USB Cable	1
Battery	1	Power Adapter	1
Belt Clip	1	User Manual	1

---

 Note

Pictures listed in this manual are for reference only.

---

# 2. Product Overview

## 2.1 Product Layout

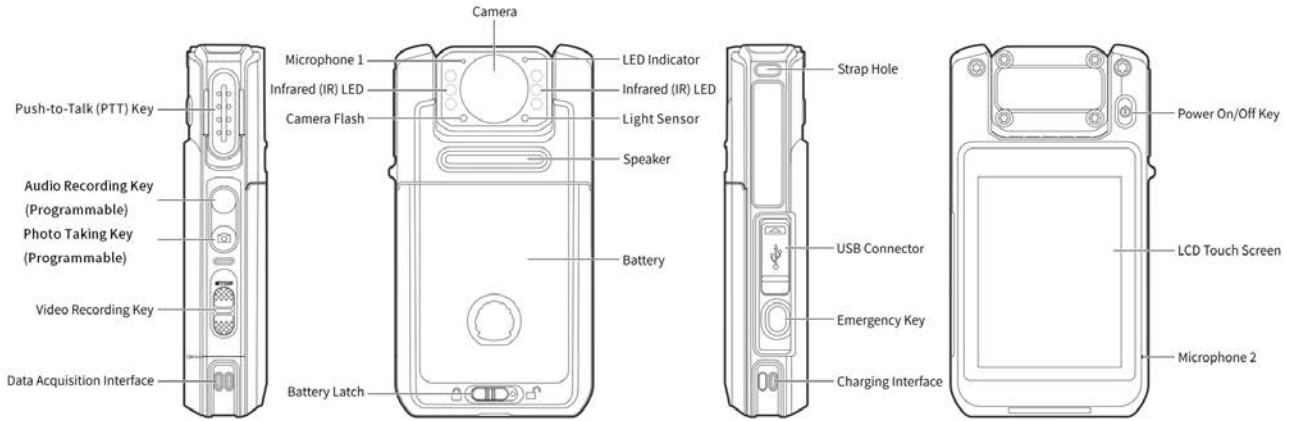

## 2.2 LED Indicators

Status	Description
Glows red	<ul style="list-style-type: none"> <li>● The product is transmitting voice or emergency alarm.</li> <li>● The product is being charged.</li> <li>● The TF card is full (lasts for three seconds).</li> <li>● The product is being turned off (lasts for two seconds).</li> </ul>
Glows green	<ul style="list-style-type: none"> <li>● The product is fully charged.</li> <li>● The product is being turned on.</li> </ul>
Flashes orange rapidly	<ul style="list-style-type: none"> <li>● The remaining capacity of the TF card is less than 2 GB (lasts for three seconds).</li> </ul>
Flashes red slowly	<ul style="list-style-type: none"> <li>● Flashes once every second: The product is recording a video.</li> <li>● Flashes once every five seconds: The battery runs low. Please recharge or replace the battery in time.</li> </ul>
Flashes orange slowly	The product is recording an audio.

## 3. Before Use

### 3.1 Installing the Nano SIM Card

Open the card slot cover and unlock the SIM card flip cover according to the instructions on it. Place the Nano SIM card into the slot and lock the flip cover and slot cover, as shown in the following figure.

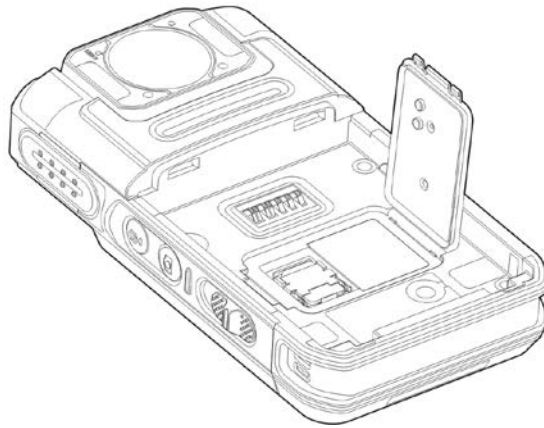

### 3.2 Attaching the Battery

---

**⚠ Caution**

Use only the Hytera standard or optional battery. Polarity reverse or use of other batteries may result in explosion and fire hazards.

---

Attach the battery according to the steps shown in the following figure. To remove the battery, turn off the product and reverse the attaching steps.



### 3.3 Attaching the Belt Clip

Attach the belt clip according to the steps shown in the following figure. To remove the belt clip, reverse the attaching steps.

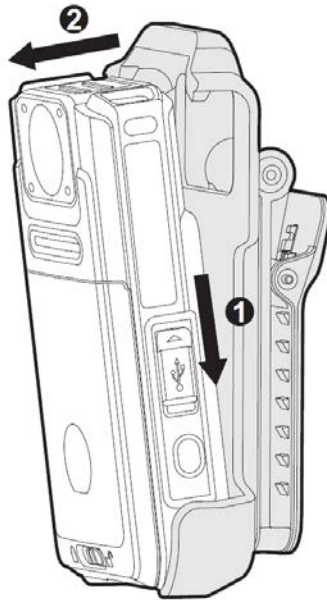

### 3.4 Charging the Product

To charge the product, do as follows:



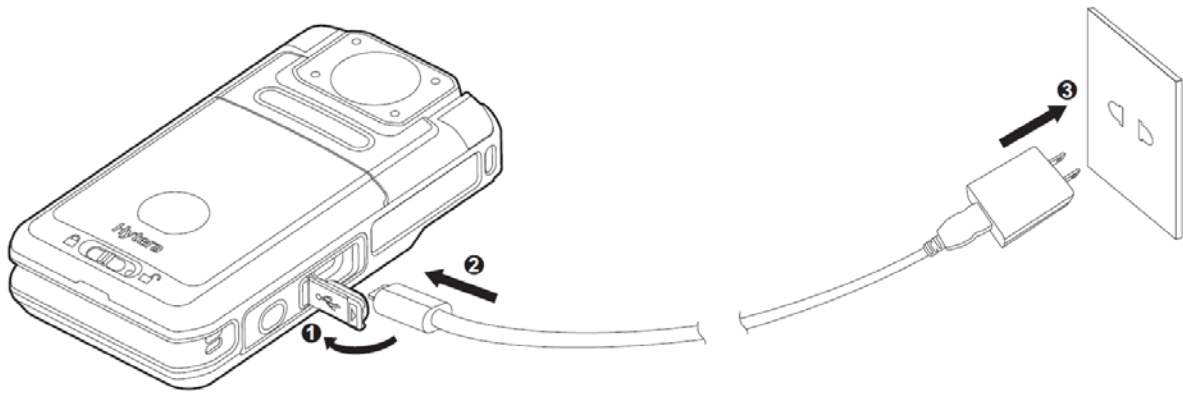

The LED indicator on the product tells its charging status, see **2.2 LED Indicators** for details.

# 4. Basic Operations

## 4.1 Turning On or Off the Product

### Turning On the Product

In power-off mode, long press the **On/Off** key for three seconds to turn on the product and enter the preview mode.



### Turning Off the Product

In power-on mode, long press the **On/Off** key for three seconds to turn off the product.

## 4.2 Connecting to Network

### 4.2.1 Cellular Data



Before enabling the cellular network, make sure that the SIM card has been registered to the Carrier Networks. When not used, disable the cellular network to save traffic and extend the standby time.

1. Wipe down from the status bar to open the notification center, and tap .
2. Tap  to enable the cellular network; or tap  to disable the cellular network.

### 4.2.2 WLAN

Connect to a WLAN (Wireless Local Area Networks) to visit the Internet or shared files from other network devices.

To use the WLAN, do one of the following:

- Enable WLAN through the shortcut switch.
  - a) Swipe down from the status bar to display all shortcut switches. Tap  to enable WLAN.
  - b) Select available network from the WLAN list.
  - c) (Optional) If the network displays with a  icon, enter the password and tap **Connect**.
- Enable WLAN through **Settings**.
  - a) Tap  on the home screen, and tap **WLAN** to enable WLAN.
  - b) Select available network from the WLAN list.

c) (Optional) If the network displays with a  icon, enter the password and tap **Connect**.

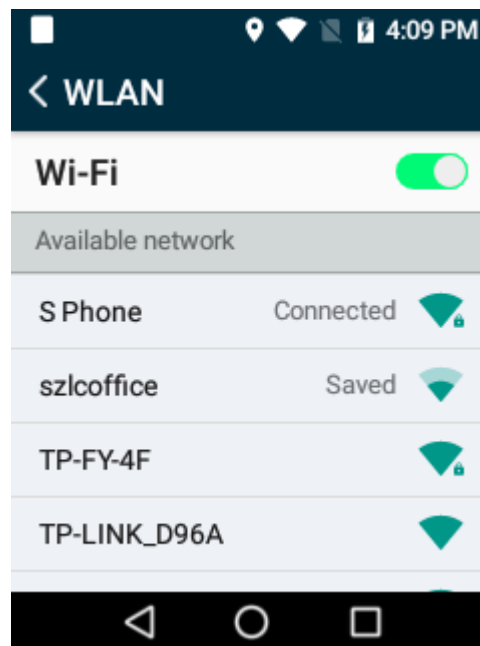

The product automatically saves WLAN information upon successful connection, and automatically connects to the network when WLAN is switched on.

## 4.3 Understanding the Screen

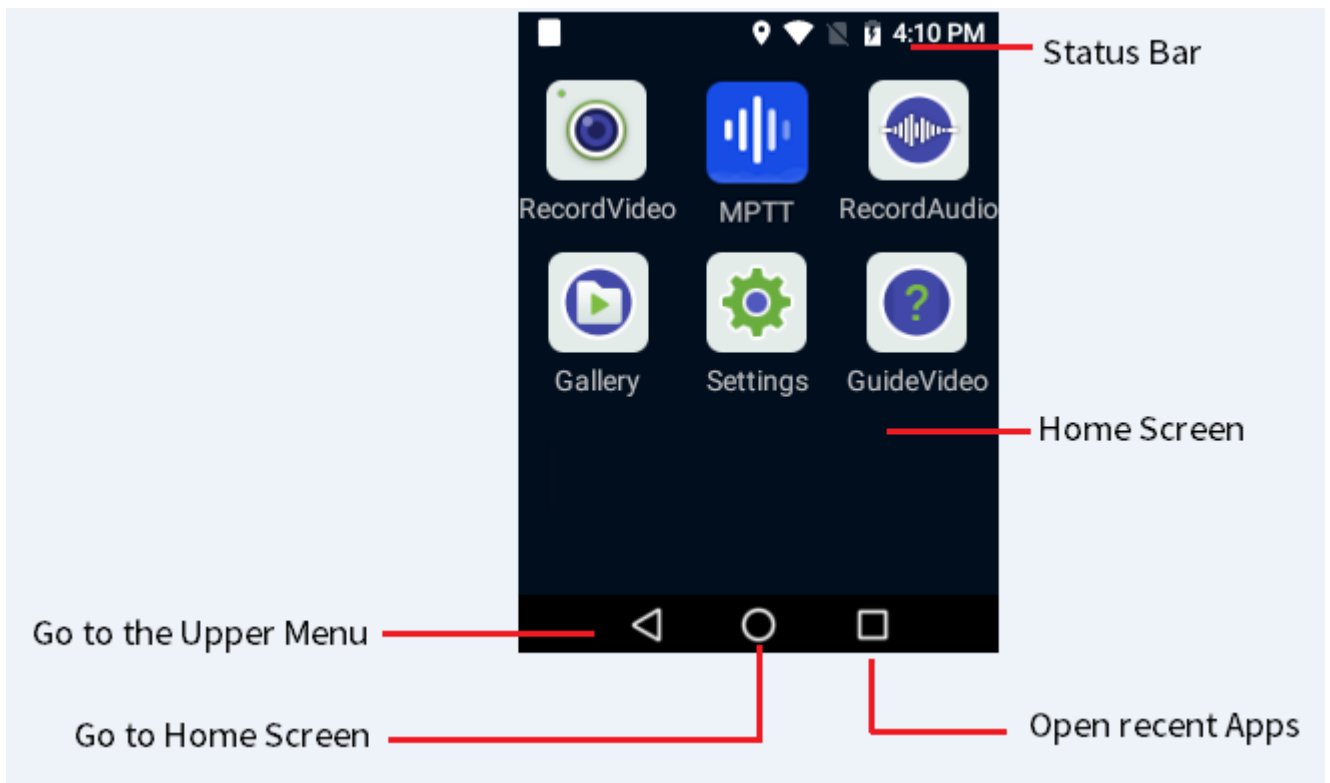

### 4.3.1 Status Display

The status bar displays the notifications and running status of the product in real-time. Common status icons are described in the following table.

Icon	Meaning	Icon	Meaning
	Airplane mode is enabled.		WLAN connection is established.
	Location information is enabled.		Cellular network is enabled.
	BT feature is enabled		No SIM card is inserted.
	BT connection is established		The battery power is full.
/	/		The battery is being charged.

### 4.3.2 Notifications and Shortcuts

New notifications display shortly on the top of screen, or display constantly in the middle of screen till you acknowledge it.

On the main screen, swipe down from the status bar to open the notification center, where you can adjust brightness, turn on or turn off shortcut switches, open settings, and view or clear notifications.

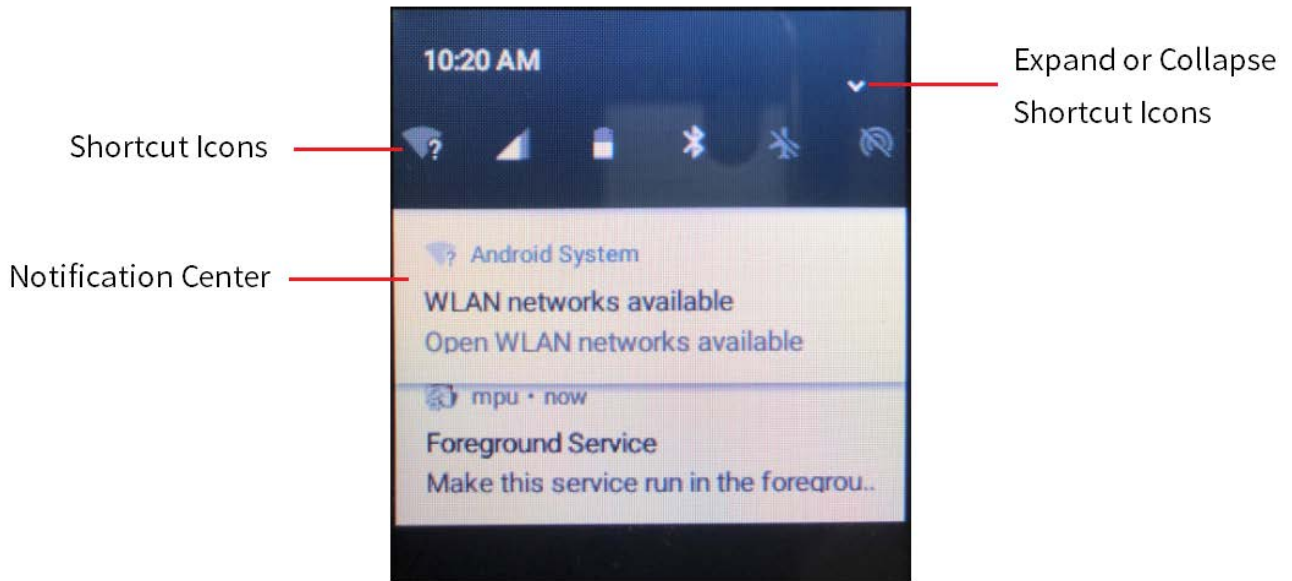

### 4.3.3 Sleep and Wakeup

#### Sleep

In power-on mode, press the **On/Off** key to enter sleep mode. You can also set the sleep time in **Settings > System Settings**; when the sleep time is up, the product enters sleep mode automatically.

#### Wakeup

When the screen goes off, press any key to wake up the screen.

# 5. System Settings

Tap  on the home screen, and enter the **Settings**. You can set the parameters according to the actual needs.

## 5.1 Network

### 5.1.1 Data Roaming

Tap **SIM Card Settings**, and toggle  to enable data roaming.

### 5.1.2 NFC

The near field communication (NFC) provides easy, fast and secure wireless connections. It allows you to identify compatible devices nearby. With the NFC enabled, you can exchange data with other nearby devices.

### 5.1.3 Airplane Mode

To avoid signal interferences while you are on a plane, please turn off the product or turn on the airplane mode. In airplane mode, the product disables data or WLAN network, and you cannot use the voice, video and data services. If the airline company permits, you can manually enable BT or WLAN feature.

Tap **System Settings**, and toggle the  following the airplane mode to enable it.

---

#### Note

You can also enable or disable the airplane mode by tapping the  icon in the shortcut switches.

---

## 5.2 Display

### 5.2.1 Brightness

#### Manual Adjustment

Tap **System Settings**, and drag the slide block in the **Display Settings** to adjust screen brightness.

---

## Note

You can also adjust brightness by dragging the slide block for brightness in the drop-down status bar.

---

## Adaptive Brightness

Tap **System Settings**, and toggle the  following the **Adaptive Brightness**.

## 5.2.2 Sleep

This feature allows the product to enter sleep mode for saving battery power, if no operation is made within predefined time.

To set the sleep time, tap **System Settings**, and tap **Sleep**.

The sleep time options include Never, 10s, 20s and 30s.

## 5.3 Sound

### 5.3.1 Volume Adjustment

Tap **System Settings**, and drag the slide blocks following media volume and ring volume in the **Sound Settings** to adjust volume.

### 5.3.2 Ring Mode

The product is set to ring mode by default. You can adjust the ring volume according to actual needs.

## 5.4 BT

You can pair the product with other BT devices to transfer data through BT feature.

1. Tap **BT**, and toggle the  following **BT** to enable it.
2. Tap a device in the device list, and tap **Pair** in the popup pair request window.

---

## Note

- If this product needs to be detected by other BT devices, toggle  following **QCOM-BTD**.
-

- 
- Other matching methods: slide down the status bar to expand all shortcut switches, and tap . Tap **More Settings**, select a device in the device list, and then tap **Pair** in the popup pair request window.
- 

## 5.5 Language

Tap **Language**, and select from the language list.

## 5.6 Location



After enabling the location information, the product obtains location information through GPS, WLAN, BT or cellular network.

1. Tap **Location**, and tap the  following **Location** to enable it.
2. Tap **Mode** to set the mode of location information.
  - High Accuracy: Use GPS, WLAN, BT and cellular network to determine location.
  - Battery saving: Use WLAN, BT and cellular network to determine location.
  - Device only: Use GPS to determine location.

You can also view the applications which have recently requested the location information.

## 5.7 Date & Time

After connected to the network, the product can synchronize the date, time, time zone and time format of the system automatically via the network.

- Tap **Date & Time**, and tap the  following **Set Automatic time zone**, the product will use the time zone provided by the network.
- Tap **Date & Time**, and tap the  following **24-hour format**, the product will use the 24-hour time format.

## 5.8 Media

Tap **Media settings** to enter the Multimedia Settings interface. You can set features such as video resolution, photo resolution, real-time resolution, photo quality, pre-recording and post-recording, strike sensitivity, watermark, split time, antibanding, loop video, AES encryption and night vision.



## 5.8.1 Video Resolution

You can set the resolution for video recording.

Tap **Video resolution**, and select from **480P 30fps**, **720P 30fps**, **720P 60fps**, **1080P 30fps** or **1080P 60fps**.

## 5.8.2 Photo Resolution

You can set the resolution for photo taking.

Tap **Photo resolution**, and select from **2304x1296**, **3072x1728** or **5328x2997**.



## 5.8.3 Photo Quality



You can set the image quality.

Tap **Photo quality**, and select from **Low**, **Medium** and **High**.

## 5.8.4 Pre-record and Post-record



The product is capable of pre- and post-recording to ensure all interactions during an incident are captured. Pre-recording allows officers to capture a period time of footage prior to an event that led them to press the record button, while post- recording can add a period time of footage after the recording is deactivated.

Tap **Pre-recorded settings** or **Delay setting** to enter the respective feature. Then tap  or  following Pre-record or Post-rec to enable or disable the feature.

- : The feature is disabled.
- : The feature is enabled.
- (Optional) You can set the pre- or post-recording time from **10s**, **20s** or **30s**.





## 5.8.5 Strike Sensitivity

With the strike recording feature enabled, upon detecting certain acceleration of movement of itself, the BWC automatically starts video recording. You can adjust the strike parameter from the menu.

1. Tap **Strike sensitivity setting**, and enter the configuration page.
2. Tap  or  following Strike to enable or disable the feature.
3. (Optional) You can set the strike sensitivity from **Low**, **Medium** or **High**.

## 5.8.6 Watermark

Watermark appears in videos or images.

1. Tap **Watermark**, and enter the configuration page.
2. Tap  or  following Watermark to enable or disable the feature.
3. (Optional) After watermark is enabled, you can tap  or  following options such as Custom Watermark, Date and Time, Device ID, User ID and GPS to display or remove respective watermarks.

## 5.8.7 Split Time

Split time defines the maximum time length of a single audio or video recording. When the product starts audio or video recording and reaches the split time, a recording file will be saved automatically and the product starts a new timing again, and loops the process.

---

Tap **Split time setting** and select from **5 min**, **10 min** or **15 min**.

## 5.8.8 Antibanding

When the product is used under indoor fluorescent lamp, its LCD screen may have flickers during video recording or take photos with stripes because of the frequency disparity between the light sensor exposure and the local AC power. To fix the flickers, set the antibanding to **Auto**, and it will adjust automatically to the environment.

Tap **Antibanding setting** and select from **50 Hz**, **60 Hz** or **Auto**.

## 5.8.9 Night Vision

With this feature enabled, the IR LED will light up when the product is recording video in the dark.

Tap **Night vision switch** and select from **On**, **Off** or **Auto**.

## 5.9 Silent Mode

In silent mode, the product gives no alarms or rings; its indicators and screen goes dim to keep the product concealment.

Tap **Silent Mode**, and toggle the  following **Silent Mode** to enable it.

## 5.10 Accounts

Tap **Accounts** to view information such as user name, user number, unit name and unit number.

## 5.11 About Device

Tap **About Device** to view information such as software version, device name, device ID, serial number, storage capacity and available space.

## 6. Basic Features

### 6.1 Recording Videos

- Normal recording: in preview mode, toggle the **Video Recording** key to start video recording; the LCD screen displays the recording time. During video recording, toggle the **Video Recording** key again to finish recording.
- Key recording: during video recording, press the **Audio Recording** key to mark the video as key recording or unmark a key recording.

### 6.2 Recording Audios

- Normal recording: in preview mode, long press the **Audio Recording** key to start audio recording; the LCD screen displays the recording time. During audio recording, long press the **Audio Recording** key again to finish recording.
- Key recording: during audio recording, press the **Audio Recording** key to mark the audio as key recording or unmark a key recording.



### 6.3 Taking Photos

Press the **Photo Taking** key to take a photo.

### 6.4 Taking Photos during Video Recording

During video recording, press the **Photo Taking** key to take a photo.

### 6.5 Flashlight

1. Tap  in the home screen, or enter video preview mode after video or audio recording or photo taking.
2. Tap  to enable flashlight; tap  to disable it.



You can also enable or disable flashlight from the shortcut switch  in the status bar.

---

## 6.6 Emergency Mode

### Enabling Emergency Mode

In emergency situations, press the **Emergency** key to enable emergency alarm. The product will start key video recording, and send an emergency alarm message to the control center (you can set emergency contact for the control center, see [7.1.4.3 Setting Call Options](#)) to seek for help.

### Disabling Emergency Mode



In emergency mode, long press the **Emergency** key to disable emergency alarm. The product will stop key video recording.

# 7. MPTT Features

## 7.1 Understanding MPTT

### 7.1.1 Logging in to the P-PoC6000 Server

To perform functions such as PoC talk, video call and video polling through the SmartOne Dispatch, you must log in to the P-PoC6000 server through MPTT (client of P-PoC6000) from the product.

1. Tap  to enter the login interface.
2. Tap , and set the IP address, port number and domain name of the main server.
3. Save the settings and return to the login interface.
4. Type the user name and password, and tap **Login**.



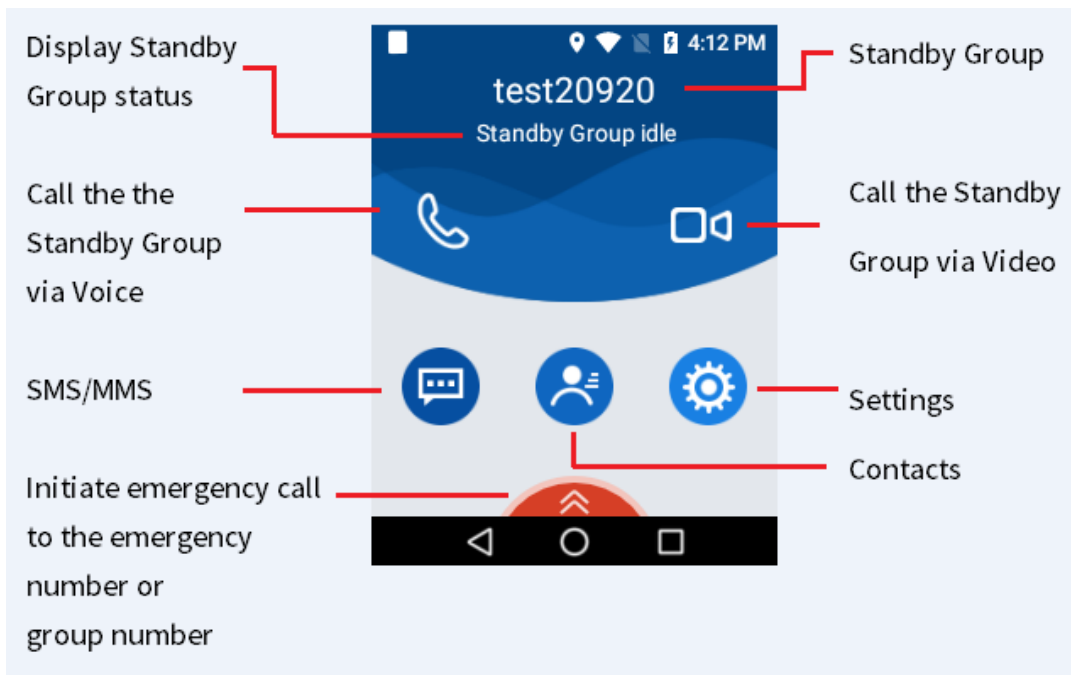

Obtain the user name and password from the administrator of your network management system (NMS).

## 7.1.2 Understanding the Main Interface

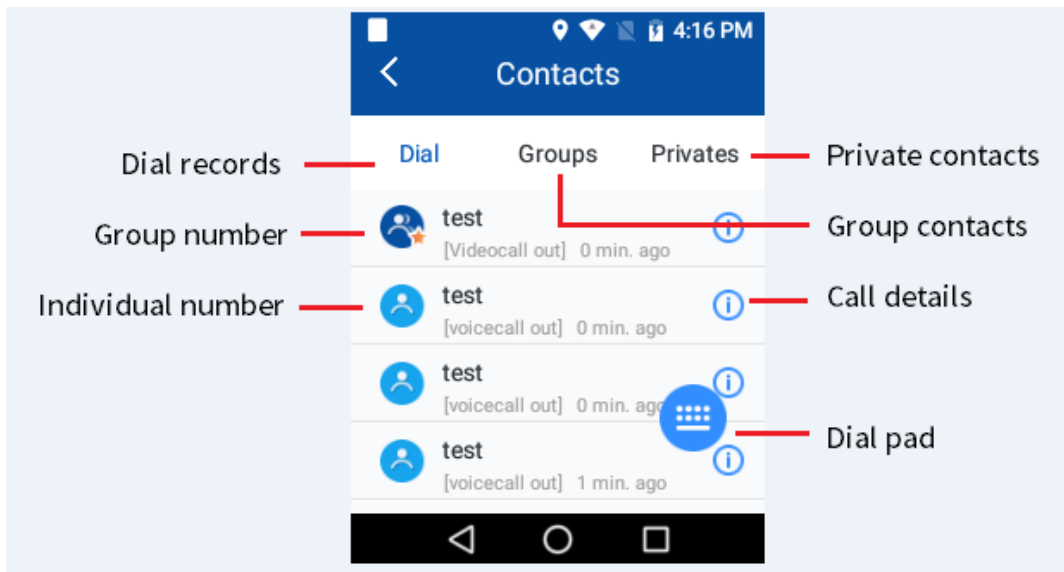

## 7.1.3 Understanding the Contacts Interface



-  stands for standby group,  stands for non-standby group,  stands for online user,  stands for offline user.
- The MPTT does not support adding, modifying or deleting the dial records, private contacts and group contacts in the **Contacts**. The private contacts and group contacts are managed via the NMS. The NMS pushes information of updated private contacts and group contacts to the MPTT.
- From the group contacts and private contacts, click a group number or private number to view the group call details (including group number, group type, call /video call/SMS/MMS shortcut, call level

and group member information) or local call details (including contact number, call level/video call, call type, SMS/MMS shortcut, call level, video type and call type).

## 7.1.4 Settings

User management includes viewing user status, viewing personal information, setting call options, setting video options, viewing version information, switching account, and quitting.

Tap  to enter **Settings**.

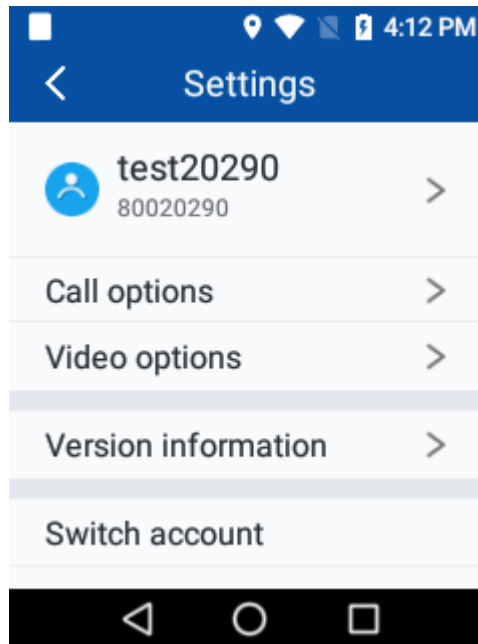

### 7.1.4.1 Viewing User Status

You can view the user status in **Settings**.  indicates user is online,  indicates user is offline.

### 7.1.4.2 Viewing Personal Information

Tap the user status icon, and enter the user information interface. You can view the user number and server information.



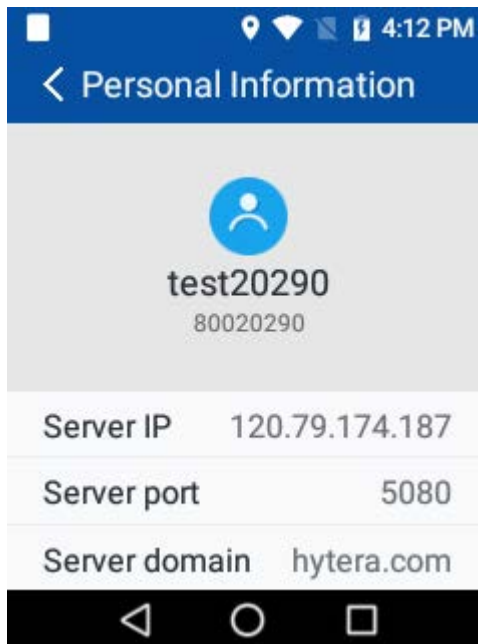

### 7.1.4.3 Setting Call Options



You can set the emergency call priority, foaoroacsu mode, emergency number and emergency group number.

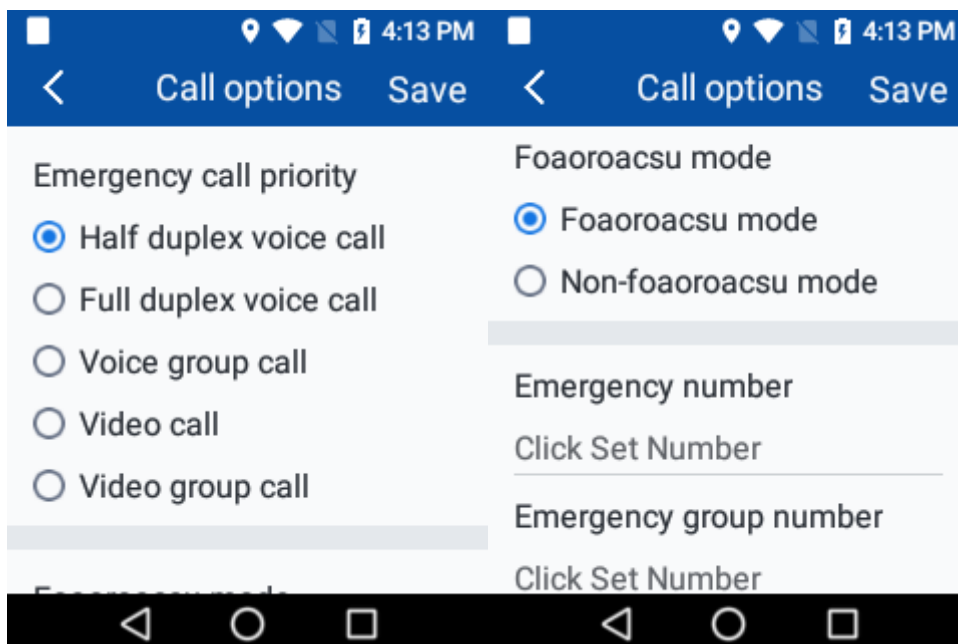

1. Tap Call options.



2. Set the related parameters.

Parameter	Meaning	Setting
Emergency call priority	Priority of the emergency call initiated through the	Set this parameter

Parameter	Meaning	Setting
	<p data-bbox="469 241 1177 501">  icon in the home screen. It must be configured with the emergency number or emergency group number, which are set in the NMS. You can also fill in the value manually. </p> <p data-bbox="469 555 1038 589">The rules of initiating emergency calls through</p> <p data-bbox="469 618 831 667">  are as follows: </p> <ul data-bbox="469 719 1177 1525" style="list-style-type: none"> <li data-bbox="469 719 1177 857">● If both emergency number and emergency group number are set, then the emergency call is initiated according to the priority.</li> <li data-bbox="469 887 1177 1025">● If only emergency number is set, and the priority is set to a private call type, then the emergency call is a corresponding private call.</li> <li data-bbox="469 1055 1177 1193">● If only emergency number is set, and the priority is set to a group call type, then the emergency call is an emergency half-duplex voice private call.</li> <li data-bbox="469 1223 1177 1361">● If only emergency group number is set, and the priority is set to a group call type, then the emergency call is a corresponding group call.</li> <li data-bbox="469 1391 1177 1525">● If only emergency group number is set, and the priority is set to a private call type, then the emergency call is an emergency voice group call.</li> </ul>	<p data-bbox="1209 241 1378 349">according to actual needs.</p>
<p data-bbox="225 1742 373 1823">Foaroacsu Mode</p>	<p data-bbox="469 1570 1177 1742">Whether the called party needs to turn on foaroacsu mode when a full-duplex voice private call (common call) or video private call (common call) is initiated.</p> <ul data-bbox="469 1805 1177 2000" style="list-style-type: none"> <li data-bbox="469 1805 1177 1886">● Foaroacsu mode: The called party needs to turn on foaroacsu mode;</li> <li data-bbox="469 1915 1177 2000">● Non-foaroacsu mode: The called party does not need to turn on foaroacsu mode.</li> </ul>	<p data-bbox="1209 1570 1442 1742">Set this parameter according to actual needs.</p>

Parameter	Meaning	Setting
Emergency number	The associated number to which an emergency call is dialed by tapping  in the home screen. It must be configured with the <b>Emergency call priority</b> .	Set this parameter according to actual number.
Emergency group number	The associated group number to which an emergency call is dialed by tapping  in the home screen or by pressing the <b>Emergency</b> key. It must be configured with the <b>Emergency call priority</b> .	Set this parameter according to actual number.

3. Tap **Save**.

#### 7.1.4.4 Setting Video Options

You can set the video information such as video resolution.

1. Tap **Video options**.

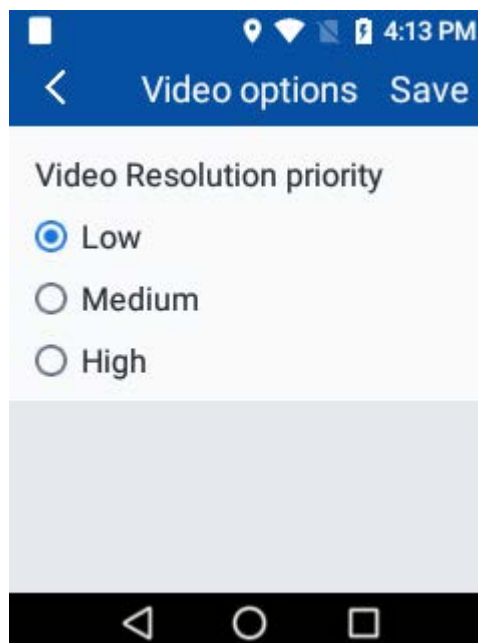

2. Set the video resolution.

3. Tap **Save**.

### 7.1.4.5 Viewing Version Information

Tap Version information.

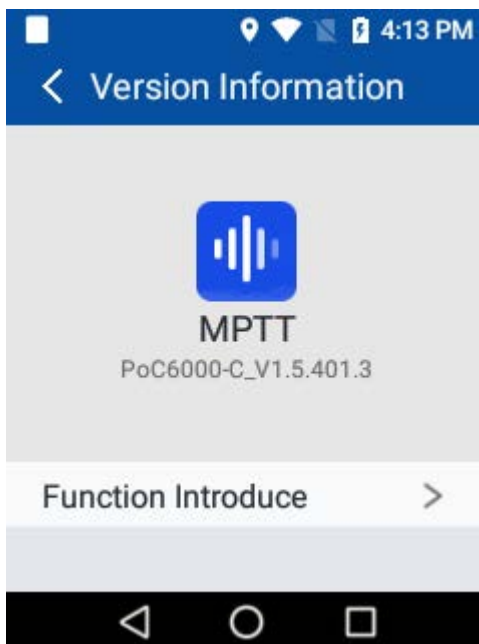

### 7.1.4.6 Switching Account

1. Tap Switch account.

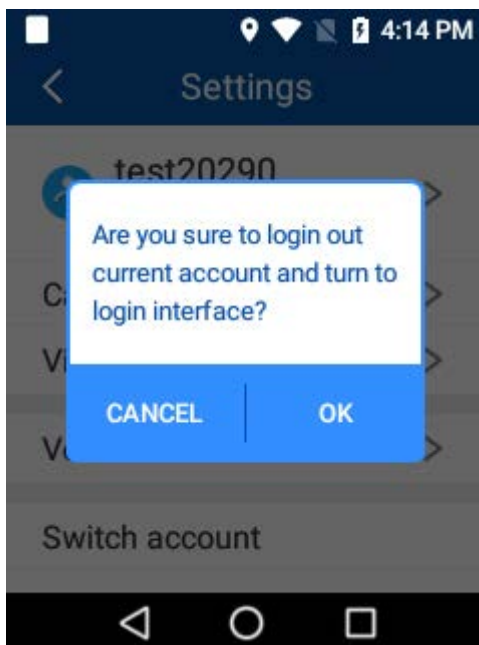

2. Tap OK to return to the login interface.

### 7.1.4.7 Quitting

1. Tap Quit.

2. Tap **OK** to log out of the MPTT.

## 7.2 Voice Services

### 7.2.1 Full-duplex Voice Private Call

Full-duplex voice private call refers to the call established between two terminals (P-PoC6000 client and P-PoC6000 client, P-PoC6000 client and SmartOne Dispatch). After the private call is established, both parties can speak at the same time.

#### Answering a Full-duplex Voice Private Call

You can answer a full-duplex voice private call in two modes: off-hook and on-hook. Answering mode is configured by the calling party, see **7.1.4.3 Setting Call Options** for details.



- Foaroacsu mode: Upon receiving a call, you need to tap  to answer.





#### Note

Tap  to reject the call.

- Non-foaroacsu mode: Upon receiving a call, you can answer the call without any operations.

#### Initiating a Full-duplex Voice Private Call

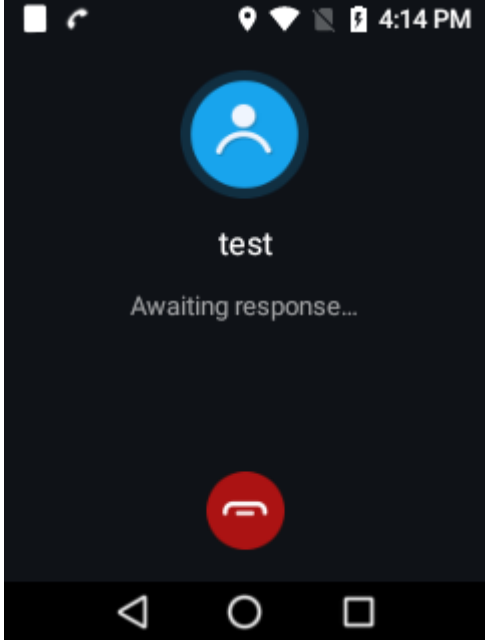
Method	Operation	Call Interface
Initiate from the private contacts	<ol style="list-style-type: none"> <li>1. Tap  in the home screen to enter <b>Contacts</b>, and then tap <b>Privates</b>.</li> <li>2. Swipe up or down to find the desired private contact, or tap  to search for the contact.</li> <li>3. Tap the contact, and enter the local call details.</li> <li>4. Set the <b>Default call type</b> as <b>Full duplex</b>.</li> <li>5. Tap  to initiate a full-duplex voice private call.</li> </ol>	The called party and the call duration are displayed in the interface.

Method	Operation	Call Interface
Initiate from the dial pad	<ol style="list-style-type: none"> <li>1. Tap  in the home screen to enter <b>Contacts</b>, and then tap  to open the dial pad.</li> <li>2. Dial the desired private contact number, and tap  to initiate a full-duplex voice private call.</li> </ol>	
Initiate from the dial records	<ol style="list-style-type: none"> <li>1. Tap  in the home screen to enter <b>Contacts</b>, the dial records are displayed.</li> <li>2. Swipe up or down to find the private contact which you initiated a full-duplex voice private call before.</li> <li>3. Tap the contact and initiate a full-duplex voice private call.</li> </ol>	

## Ending a Full-duplex Voice Private Call

Tap  to end the call.

## 7.2.2 Half-duplex Voice Private Call

Half-duplex voice private call refers to the call established between two terminals (P-PoC6000 client and P-PoC6000 client, P-PoC6000 client and SmartOne Dispatch). After the private call is established, only one party can speak at the same time.





## Answering a Half-duplex Voice Private Call

Upon receiving a half-duplex voice private call, you need to tap  to answer.

### Note

Tap  to reject the call.

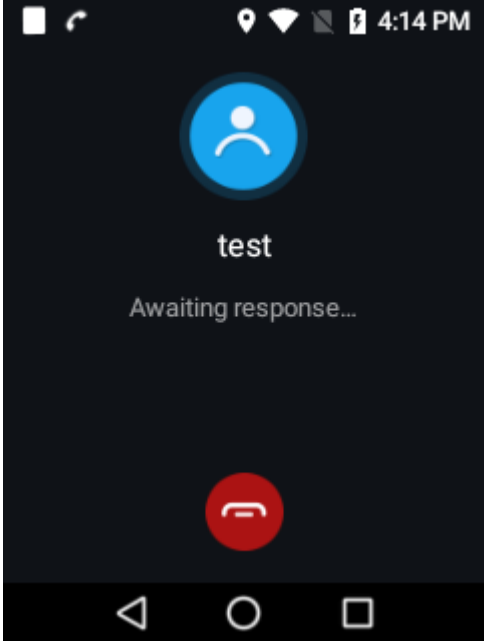
## Initiating a Half-duplex Voice Private Call

Method	Operation	Call Interface
Initiate from the private contacts	<ol style="list-style-type: none"> <li>1. Tap  in the home screen to enter <b>Contacts</b>, and then tap <b>Privates</b>.</li> <li>2. Swipe up or down to find the desired private contact, or tap  to search for the contact.</li> <li>3. Tap the contact, and enter the local call details.</li> <li>4. Set the <b>Default call type</b> as <b>Half duplex</b>.</li> <li>5. Tap  to initiate a half-duplex voice private call.</li> </ol>	<p>The called party and the call duration are displayed in the interface.</p> 
Initiate from the dial records	<ol style="list-style-type: none"> <li>1. Tap  in the home screen to enter <b>Contacts</b>, the dial records are displayed.</li> <li>2. Swipe up or down to find the private contact which you initiated a half-duplex voice private call before.</li> <li>3. Tap the contact and initiate a half-duplex voice private call.</li> </ol>	

## Applying for or Releasing the Talk Right

Press and hold the **PTT** key to apply for talk right and speak; release the **PTT** key to release talk right.

## Ending a Half-duplex Voice Private Call

Tap  to end the call.







## 7.2.3 Voice Group Call

Voice group call refers to the half-duplex voice call established between the terminal (P-PoC6000 client or SmartOne Dispatch) and all members in a group. After the group call is established, only one group member can speak at the same time.

### Answering a Voice Group Call

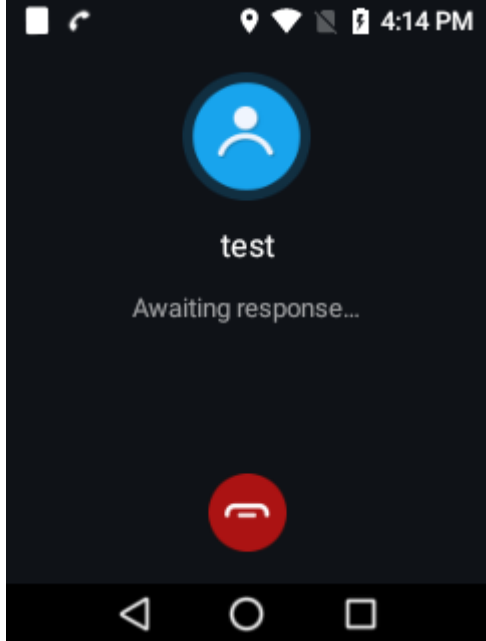
Upon receiving a voice group call, you can answer the call without any operations.

### Initiating a Voice Group Call

Method	Operation	Call Interface
Initiate from the group contacts	<ol style="list-style-type: none"> <li>1. Tap  in the home screen to enter <b>Contacts</b>, and then tap <b>Groups</b>.</li> <li>2. Swipe up or down to find the desired group contact, or tap  to search for the contact.</li> <li>3. Tap the contact, and enter the group call details.</li> <li>4. Tap  to initiate a voice group call.</li> </ol>	<p>The called party and the call duration are displayed in the interface.</p> 
Initiate from the dial pad	<ol style="list-style-type: none"> <li>1. Tap  in the home screen to enter <b>Contacts</b>, and then tap  to open the dial pad.</li> <li>2. Dial the desired group contact number, and tap  to initiate a voice group call.</li> </ol>	
Initiate from the dial records	<ol style="list-style-type: none"> <li>1. Tap  in the home screen to enter <b>Contacts</b>, the dial records are displayed.</li> <li>2. Swipe up or down to find the group contact which you initiated</li> </ol>	



Method	Operation	Call Interface
	a voice group call before. 3. Tap the contact and initiate a voice group call.	
Initiate group call to the standby group	Tap  on the home screen, or press and hold the <b>PTT</b> key to initiate a voice group call to the standby group by default.	

## Applying for or Releasing the Talk Right

Press and hold the **PTT** key to apply for talk right and speak; release the **PTT** key to release talk right.

## Ending a Voice Group Call

Tap  to end the call.

### 7.2.4 Broadcast Call

Broadcast call refers to the call initiated by the SmartOne Dispatch to a specified group. After the broadcast call is established, the members of the group can only listen and cannot talk.

### 7.2.5 Emergency Voice Call







Emergency voice call refers to the call initiated by the terminal (P-PoC6000 client or SmartOne Dispatch) to a specified number (private or group contact) to seek for help from the control center. It has the highest priority, and can override other calls of lower priority.

## Answering an Emergency Voice Call

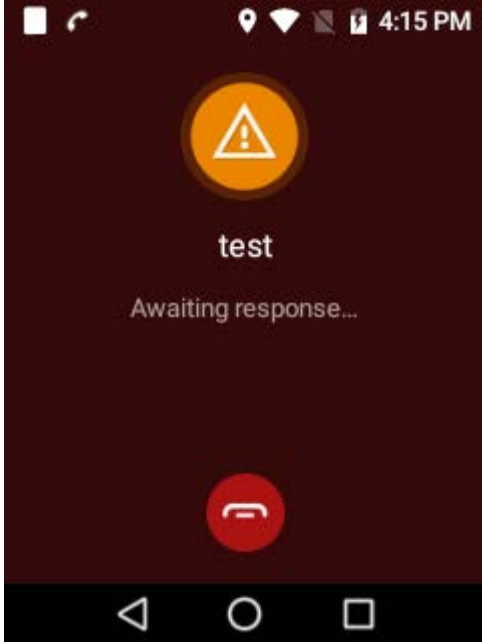
Upon receiving an emergency call, you can answer the call without any operations.

## Initiating an Emergency Voice Call

Method	Operation	Call Interface
Initiate emergency call to the associated contact	Prerequisite: The <b>Emergency call priority</b> and <b>Emergency number</b> or <b>Emergency group number</b> in the Call	The emergency call icon, called party and the call duration are displayed in

Method	Operation	Call Interface
	<p>options interface are configured. See <b>7.1.4.3 Setting Call Options.</b></p> <p>Operation: Swipe  up to initiate an emergency call.</p>	<p>the interface.</p> 
<p>Initiate from the group contacts</p>	<ol style="list-style-type: none"> <li>1. Tap  in the home screen to enter <b>Contacts</b>, and then tap <b>Groups</b>.</li> <li>2. Swipe up or down to find the desired group contact, or tap  to search for the contact.</li> <li>3. Tap the contact, and enter the group call details.</li> <li>4. Set the <b>Default call level</b> as <b>Emergency call</b>.</li> <li>5. Tap  to initiate an emergency voice group call.</li> </ol>	
<p>Initiate from the private contacts</p>	<ol style="list-style-type: none"> <li>1. Tap  in the home screen to enter <b>Contacts</b>, and then tap <b>Privates</b>.</li> <li>2. Swipe up or down to find the desired private contact, or tap  to search for the contact.</li> <li>3. Tap the contact, and enter the local call details.</li> <li>4. Set the <b>Default call level</b> as <b>Emergency call</b>.</li> <li>5. Set the <b>Default call type</b> as <b>Full duplex</b> or <b>Half duplex</b> according to your needs.</li> <li>6. Tap  to initiate an</li> </ol>	

Method	Operation	Call Interface
	emergency full-duplex or half-duplex voice private call.	

## Applying for or Releasing the Talk Right

Press and hold the **PTT** key to apply for talk right and speak; release the **PTT** key to release talk right.

## Ending an Emergency Voice Call

Tap  to end the call.

### 7.2.6 DGNA

Dynamic group number assignment (DGNA) refers to the temporary grouping of P-PoC6000 clients by the dispatcher. After the dynamic group is created, the dispatcher and dynamic group member can initiate a half-duplex voice call to the dynamic group.

## 7.3 Video Services

### 7.3.1 Video Private Call

Video private call refers to the two-way video call with or without voice established between two terminals (P-PoC6000 client and P-PoC6000 client, P-PoC6000 client and SmartOne Dispatch, SmartOne Dispatch and SmartOne Dispatch).

- After the two-way voice call with voice is established, both parties can speak and see each other at the same time.
- After the two-way video call without voice is established, both parties can see each other at the same time, but they cannot speak.

### Answering a Video Private Call

You can answer a video private call in two modes: foaoroacsu mode and non-foaoroacsu mode. Answering mode is configured by the calling party, see **7.1.4.3 Setting Call Options** for details.







- Foaroacsu mode: Upon receiving a call, you need to tap  to answer.

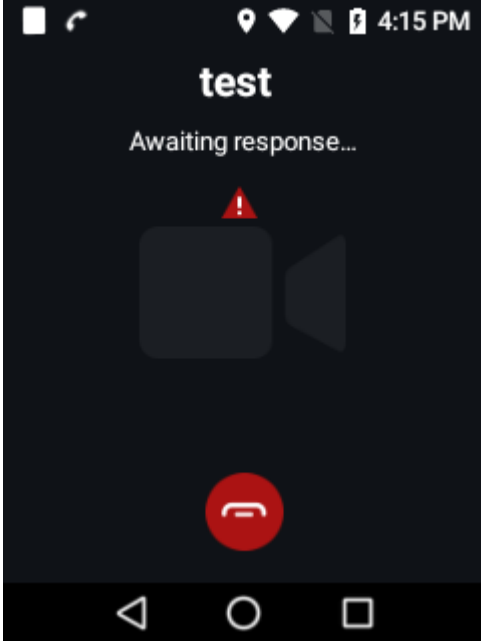

Tap  to reject the call.

- Non-fooroacsu mode: Upon receiving a call, you can answer the call without any operations.

## Initiating a Video Private Call

Method	Operation	Call Interface
Initiate from the private contacts	<ol style="list-style-type: none"> <li>1. Tap  in the home screen to enter <b>Contacts</b>, and then tap <b>Privates</b>.</li> <li>2. Swipe up or down to find the desired private contact, or tap  to search for the contact.</li> <li>3. Tap the contact, and enter the local call details.</li> <li>4. Set the <b>Default video call</b> as <b>With sound</b> or <b>Without sound</b>.</li> <li>5. Tap  to initiate a video private call.</li> </ol>	<p>The called party, call duration and video are displayed in the interface.</p> 
Initiate from the dial pad	<ol style="list-style-type: none"> <li>1. Tap  in the home screen to enter <b>Contacts</b>, and then tap  to open the dial pad.</li> <li>2. Dial the desired private contact number, and tap  to initiate a video private call.</li> </ol>	
Initiate from the dial records	<ol style="list-style-type: none"> <li>1. Tap  in the home screen to enter <b>Contacts</b>, the dial records are displayed.</li> <li>2. Swipe up or down to find the private contact which you initiated a video private call before.</li> </ol>	

Method	Operation	Call Interface
	3. Tap the contact and initiate a video private call.	

## Ending a Video Private Call

Tap  to end the call.





## 7.3.2 Video Group Call



Voice group call refers to the one-way video call with voice established between the terminal (P-PoC6000 client or SmartOne Dispatch) and all members in a group. After the group call is established, only one group member (the talk right party) can speak at the same time, and other group members can only listen and see the video of the talk right party.

## Answering a Video Group Call

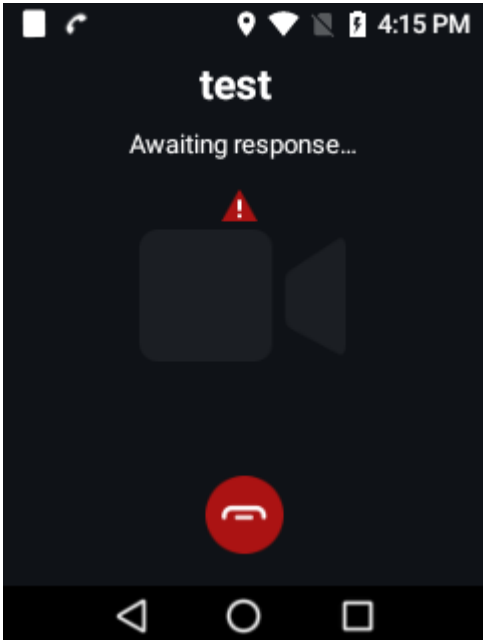
Upon receiving a video group call, you can answer the call without any operations.

## Initiating a Video Group Call

Method	Operation	Call Interface
Initiate from the group contacts	<ol style="list-style-type: none"> <li>1. Tap  in the home screen to enter <b>Contacts</b>, and then tap <b>Groups</b>.</li> <li>2. Swipe up or down to find the desired group contact, or tap  to search for the contact.</li> <li>3. Tap the contact, and enter the group call details.</li> <li>4. Tap  to initiate a video group call.</li> </ol>	<p>The called party, call duration and video are displayed in the interface.</p> 
Initiate from the dial pad	<ol style="list-style-type: none"> <li>1. Tap  in the home screen to enter <b>Contacts</b>, and then tap  to open the dial pad.</li> <li>2. Dial the desired group contact</li> </ol>	

Method	Operation	Call Interface
	number, and tap  to initiate a video group call.	
Initiate from the dial records	<ol style="list-style-type: none"> <li>1. Tap  in the home screen to enter <b>Contacts</b>, the dial records are displayed.</li> <li>2. Swipe up or down to find the group contact which you initiated a video group call before.</li> <li>3. Tap the contact and initiate a video group call.</li> </ol>	
Initiate group call to the standby group	Tap  on the home screen to initiate a video group call to the standby group.	

## Applying for or Releasing the Talk Right

Press and hold the **PTT** key to apply for talk right and speak; release the **PTT** key to release talk right.

## Ending a Video Group Call

Tap  to end the call.

### 7.3.3 Video Pulling

By video polling, the SmartOne Dispatch initiates a one-way video session to the P-PoC6000 client, and pulls the video of the P-PoC6000 client to the SmartOne Dispatch

### 7.3.4 Video Forwarding

#### Forwarding Video to Group

By forwarding video to group, the SmartOne Dispatch initiates a one-way video session without voice to a group, and forwards the video of the specified terminal (P-PoC6000 client or SmartOne Dispatch) to the terminals in the group. The terminal specified by the SmartOne Dispatch can be a terminal in the group or other terminal.

When the video is forwarded to the group, the members in the group can only see the specified terminal video forwarded by the SmartOne Dispatch, and cannot apply for talk right.

## Forwarding Video to Terminal

By forwarding video to terminal, the SmartOne Dispatch initiates a one-way video session without voice to a terminal, and forwards the video of the specified terminal (P-PoC6000 client or SmartOne Dispatch) directly to the terminal.

When the video is forwarded to the terminal, the terminal can only see the terminal video forwarded by the SmartOne Dispatch, and cannot apply for talk right.

## 7.3.5 Video Pushing

### Pushing Video to Group

By pushing video to group, the SmartOne Dispatch initiates a one-way video session without voice to a group, and push the local video of the SmartOne Dispatch to the terminals in the group.

When the video is pushed to the group, the members in the group can only see the video pushed by the SmartOne Dispatch, and cannot apply for talk right.

### Pushing Video to Terminal

By pushing video to terminal, the SmartOne Dispatch initiates a one-way video session without voice to a terminal (P-PoC6000 client or SmartOne Dispatch), and push the local video of the SmartOne Dispatch directly to the terminal.

When the video is pushed to the terminal, the terminal can only see the video pushed by the SmartOne Dispatch, and cannot apply for talk right.







## 7.3.6 Emergency Video Call

### Answering an Emergency Video Call

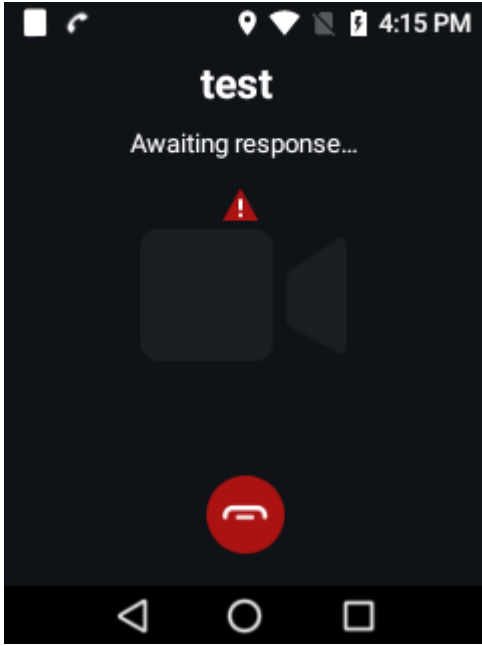
Upon receiving an emergency call, you can answer the call without any operations.

### Initiating an Emergency Video Call

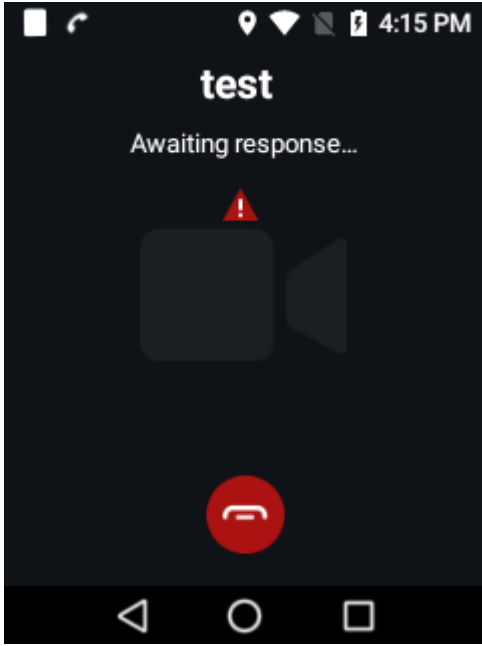
Method	Operation	Call Interface
Initiate emergency call to the	Prerequisite: The <b>Emergency call priority</b> and <b>Emergency Number</b> or	The emergency call icon, called party, call duration and video are displayed

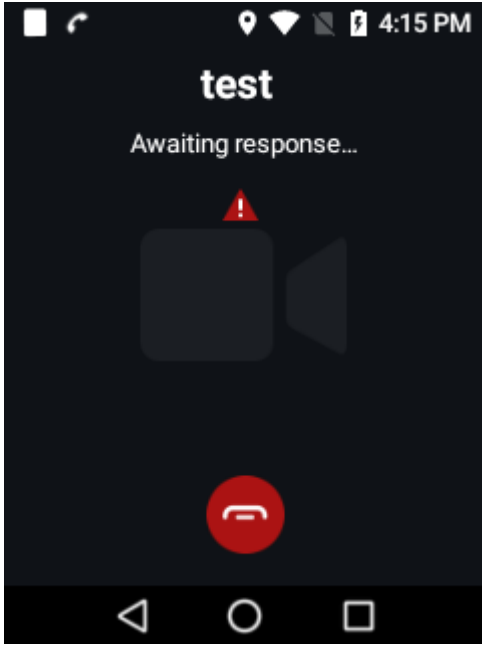
Method	Operation	Call Interface
associated contact	<p><b>Emergency Group Number</b> in the Call options interface are configured. See <b>7.1.4.3 Setting Call Options</b>.</p> <p>Operation: Swipe  up to initiate an emergency call.</p>	<p>in the interface.</p> 
Initiate from the group contacts	<ol style="list-style-type: none"> <li>1. Tap  in the home screen to enter <b>Contacts</b>, and then tap <b>Groups</b>.</li> <li>2. Swipe up or down to find the desired group contact, or tap  to search for the contact.</li> <li>3. Tap the contact, and enter the group call details.</li> <li>4. Set the <b>Default call level</b> as <b>Emergency call</b>.</li> <li>5. Tap  to initiate an emergency video group call.</li> </ol>	
Initiate from the private contacts	<ol style="list-style-type: none"> <li>6. Tap  in the home screen to enter <b>Contacts</b>, and then tap <b>Privates</b>.</li> <li>7. Swipe up or down to find the desired private contact, or tap  to search for the contact.</li> <li>8. Tap the contact, and enter the local call details.</li> <li>9. Set the <b>Default call level</b> as <b>Emergency call</b>.</li> <li>10. Set the <b>Default video call</b> as <b>With sound</b> or <b>Without sound</b> according to your needs.</li> </ol>	



Method	Operation	Call Interface
	11. Tap  to initiate an emergency video private call.	

## Applying for or Releasing the Talk Right

Press and hold the **PTT** key to apply for talk right and speak; release the **PTT** key to release talk right.

## Ending an Emergency Video Call

Tap  to end the call.

## 7.3.7 Real-time Uploading

This feature allows the BWC to upload the photos or videos to the designated dispatcher in real-time.



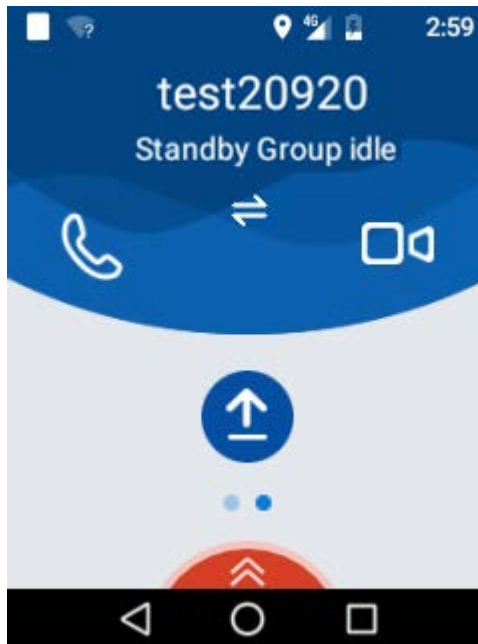

1. Wipe left from the home page, the following interface appears.

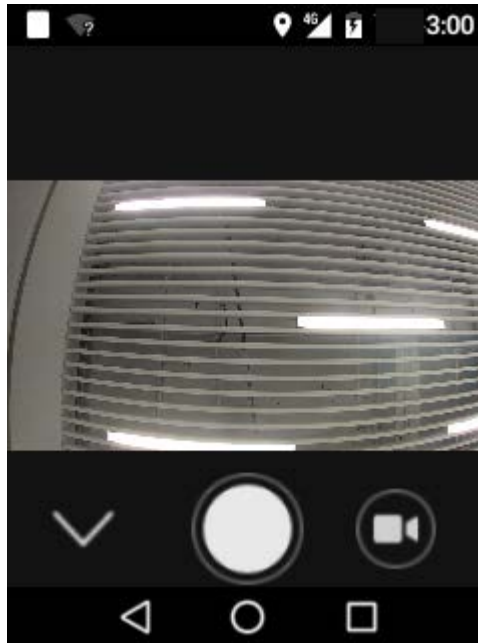

2. Tap , and the following interface appears.



3. Adjust the camera direction, and then take photos or record videos.

- Tap  to switch to video recording mode, and then tap  to record a video.
- Tap  to switch to photo taking mode, and then tap  to take a photo.

4. In the following interface, tap  to upload the photo or video; tap  to cancel the uploading.

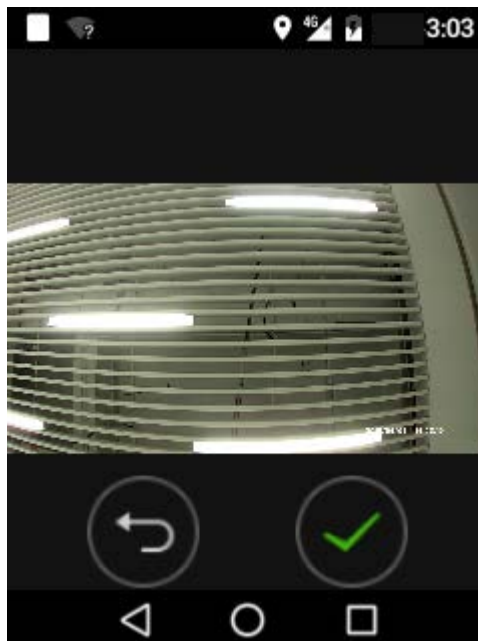

## 7.4 SMS/MMS

- Short message service (SMS) is a type of data service. SMS is divided into text message and status message

- Text message refers to the content of a text message sent between two terminals and between a terminal and a group
- Status message refers to the user-defined status code sent between two terminals and between a terminal and a group.
- Multimedia messaging service (MMS) refers to the pictures, videos, audios or other files sent between two terminals or between a terminal and a group.

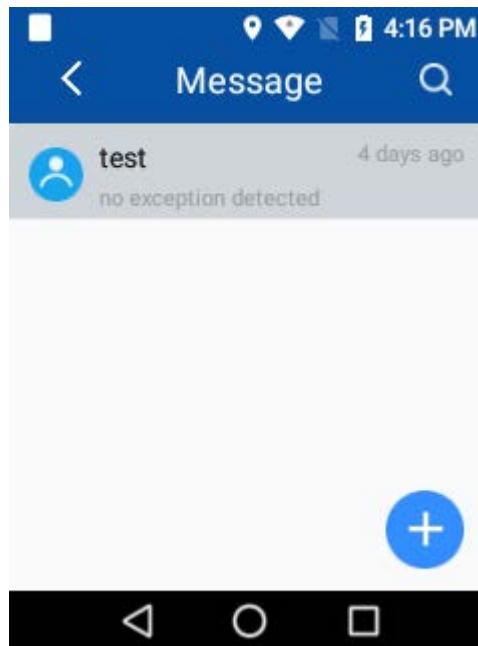

## 7.4.1 Sending an SMS/MMS

1. Tap  to enter the messages.

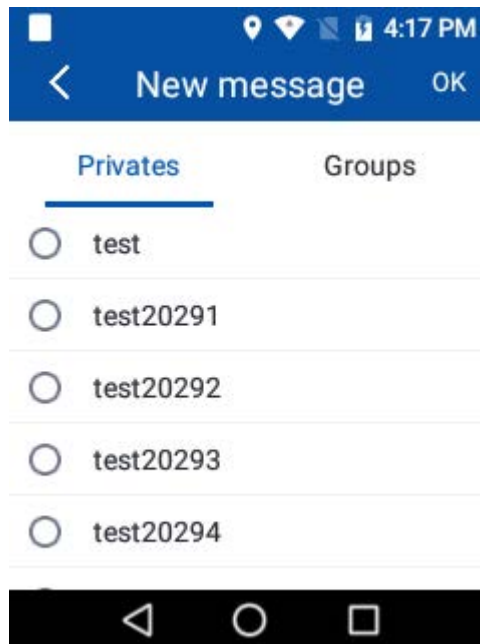

2. Create a new message or enter an existed session.
  - Create a new message: tap  to create a new message; you can select a private or group contact, and tap **OK**.



- Enter an existed session: tap an existed session to enter it.
3. Enter text content in the text box and tap  to send text message; or tap  and select from **Picture**, **Video file**, **Other file**, **Status** or **Audio file** to choose corresponding files and tap **Send** to send the multimedia content.

## 7.4.2 Viewing an SMS/MMS

1. Tap  to enter the messages.

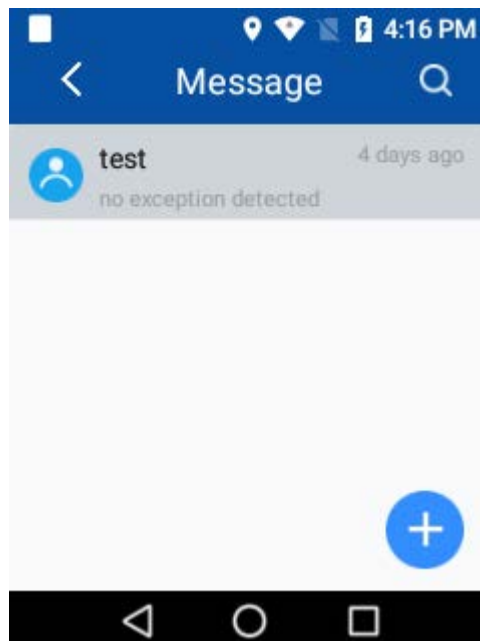

2. Tap an unread message to view it.

## 7.4.3 Managing SMS/MMS

You can transform, delete or multi-select message contents, set sessions as top or cancel, and mark messages as unread or read.

### 7.4.3.1 Managing Contents

1. Tap  to enter the messages.

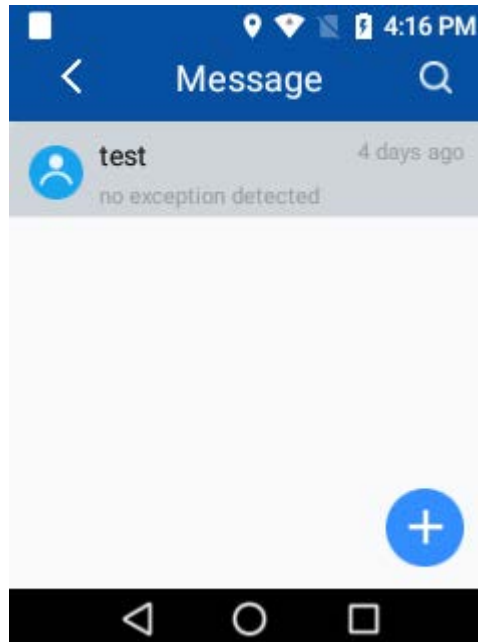

2. Tap a session.

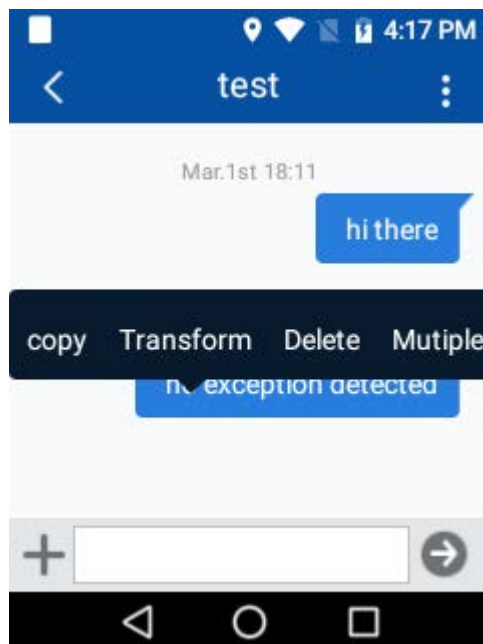

3. Long press a content, and select from **Transform**, **Delete** or **Multi-select**.

## 7.4.3.2 Managing Sessions

1. Tap  to enter the messages.

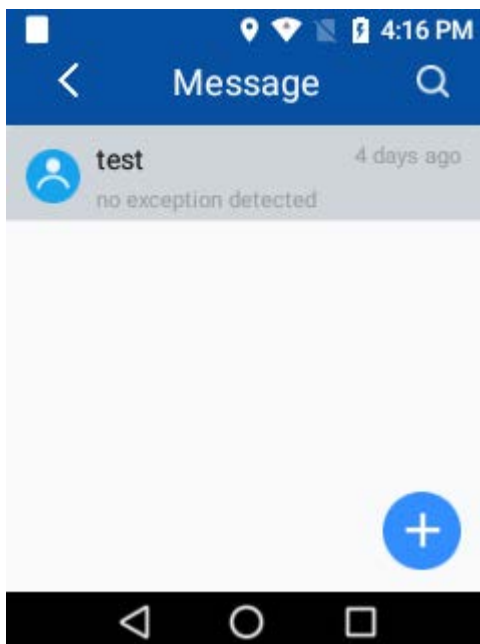

2. Long press a session, and select from **Set Top**, **Cancel Top**, **Mark as Unread**, **Mark as Read** or **Delete**.

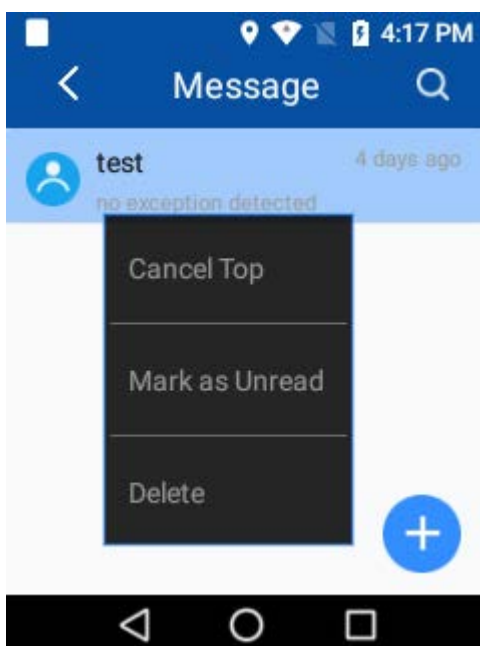

## 7.5 Other Services

### 7.5.1 Monitoring

The SmartOne Dispatch can monitor a specified P-PoC6000 client or group. When the P-PoC6000 client

or group participate in a voice call or SMS, the SmartOne Dispatch will also receive the voice call or SMS from the P-PoC6000 client or group. The monitored party does not know whether he or she is being monitored.

## 7.5.2 Overriding

By overriding, the SmartOne Dispatch forcibly terminates an monitored ongoing voice call and forcibly releases the occupied resources.

## 7.5.3 Interruption

By interruption, the SmartOne Dispatch forcibly interrupts an ongoing voice call where a P-PoC6000 client is talking and forcibly obtains the talk right.

## 7.5.4 Stun

The SmartOne Dispatch can stun a P-PoC6000 client and ban its features. A stunned P-PoC6000 client can only log in or log out, and cannot perform other services.

## 7.5.5 Revive

The SmartOne Dispatch can revive a stunned P-PoC6000 client, and restore its features. A revived P-PoC6000 client can perform services normally.

## 7.5.6 Positioning

The location server subscribes the location information of the P-PoC6000 client, and the P-PoC6000 client reports its location information to the location server in real-time, and then the SmartOne Dispatch subscribes the location information of the P-PoC6000 client through the location server.

## 7.5.7 Subscription

The SmartOne Dispatch can subscribe information of device, group and calls from the P-PoC6000 server. Upon receiving the subscription request, the P-PoC6000 server returns with the requested information. When the subscribed information changes, the P-PoC6000 server actively pushes the information to the SmartOne Dispatch. Subscription information includes the correspondence between device and group, user registration status, user call status, group call status and system online call status.

## 8. Playing Back Videos/Audios/Photos

1. Tap  in the home screen; enter the password (123456 as initial password) and tap **OK**.
2. Tap **Video**, **Audio** or **Picture** to enter the playback list of corresponding media.
3. Tap the video, audio or photo to play back.



## 9. Data Acquisition

You can set the product into disk mode through the BWC Manager, and copy photos, audios and videos to your PC. For details on the operations, refer to the *BWC Manager Operation Guide* in the BWC Manager folder.

To connect the product with your PC, do as follows:

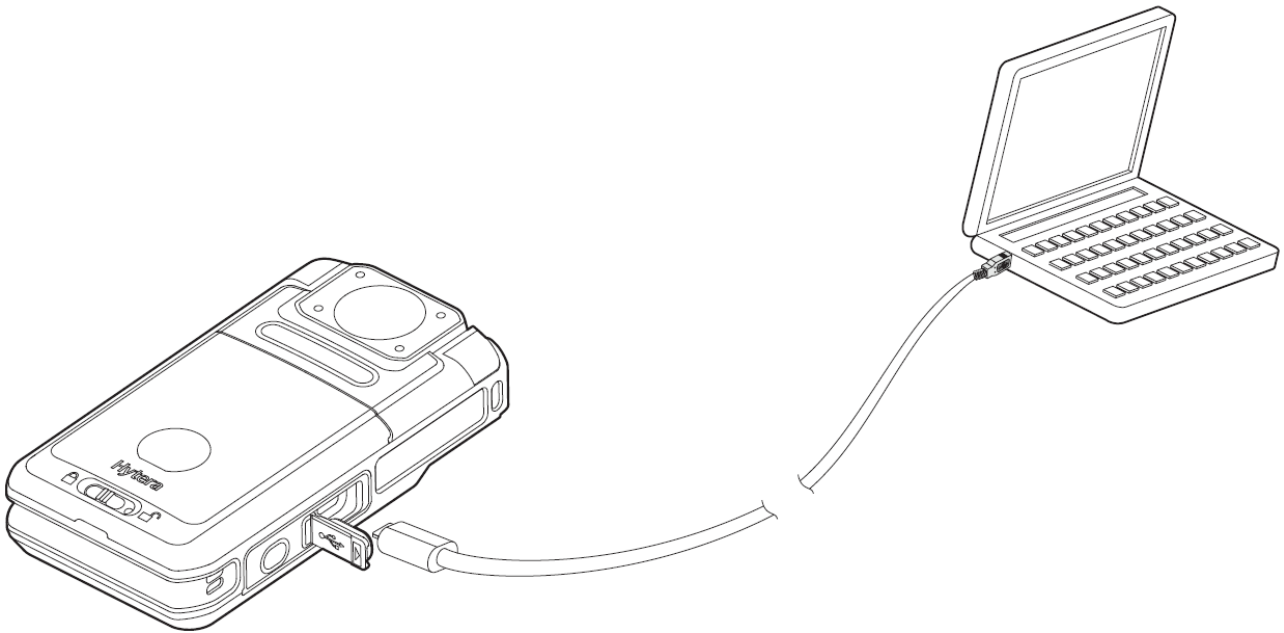

If you have purchased the multi-unit charger, you can also perform data acquisition through the charger. For details, refer to the related user manual.

# 10. Troubleshooting

Phenomena	Analysis	Solution
The product cannot be turned on	The battery may be improperly attached.	Remove the battery and attach it again.
	The battery may run out.	Recharge or replace the battery.
	The battery and the charging probes are in poor contact due to dirtied or damaged battery contacts.	Clean the battery contacts.
The volume is low when playing back audios or videos	The microphone and the speaker are blocked or damaged.	Clean the microphone and the speaker.
The product cannot record video or audio.	The TF card is full.	Switch to disk mode, and delete all data from the TF card after exporting them.
The product cannot take photo.		
The product cannot pre-record or extend-record the video.	The pre- or extend-recording feature is not enabled.	Enable the feature.
The product does not turn on the IR LED automatically when recording video in dark environment.	The IR LED feature is not enabled.	Enable the IR LED feature.
The product gives no alert tone; the indicator does not light up.	The Silent Mode is enabled.	Disable the Silent Mode.
The product gives no response to operations.	The product has crashed.	Press the <b>Power On/Off</b> key for 10 seconds to forcibly turn the product

Phenomena	Analysis	Solution
		off.

If the above solutions cannot solve your problems, or you may have some other queries, please contact us or your local dealer for more technical support.

# 11. Care and Cleaning

To guarantee optimum performance as well as a long service life of the product, please follow the tips below.

## Product Care

- Do not pierce or scrape the product.
- Keep the product away from substances that can corrode the circuitry.
- Do not hold the product by the connection cable.
- Attach the USB port cover when the USB port is not in use.

## Product Cleaning

---

### Caution

- Power off the product before cleaning.
  - Make sure the product is completely dry before use.
- 

- Clean up the dust and fine particles on the product's surface with a clean and dry lint-free cloth or a brush regularly.
- Use neutral cleanser and a non-woven fabric to clean the keys and surface after long-time use. Do not use chemical preparations such as stain removers, alcohol, sprays or oil preparations, so as to avoid surface damage.

## 12. Optional Accessories

---

 Caution

Use the accessories specified by the Company only; otherwise, we shall not be liable for any losses or damages arising out of the use of any unauthorized accessories.

---

Contact your local dealer for the optional accessories of the product.



is the trademark or registered trademark of Hytera Communications Corporation Limited. ©2019 Hytera Communications Corporation Limited. All Rights Reserved.

Address: Hytera Tower, Hi-Tech Industrial Park North, 9108# Beihuan Road, Nanshan District, Shenzhen, People's Republic of China

Postcode: 518057

[http:// www.hytera.com](http://www.hytera.com)