

ITEM NO.	DESCRIPTION	QTY.
1	FISH ATTRACTOR LIMB 92"	62
2	FISH CUBE TRUNK 5 FT	4
3	HEX BOLT 1/2-13 X 5 1/2 18-8 SS	4
4	HEX NUT 1/2-13 NYLOK 18-8 SS	4

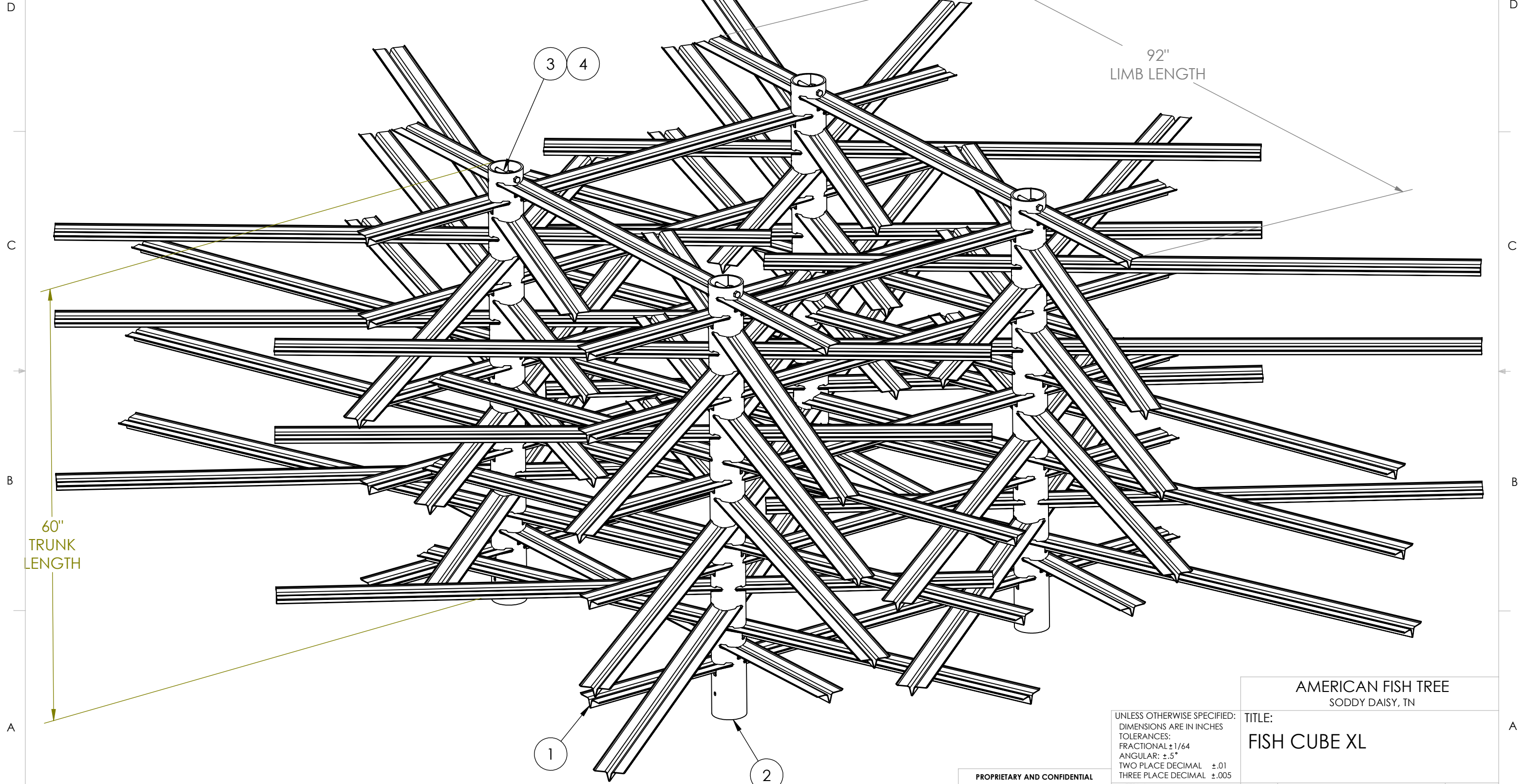

UNLESS OTHERWISE SPECIFIED:
 DIMENSIONS ARE IN INCHES
 TOLERANCES:
 FRACTIONAL: ±1/64
 ANGULAR: ±.5°
 TWO PLACE DECIMAL ±.01
 THREE PLACE DECIMAL ±.005

PROPRIETARY AND CONFIDENTIAL
 THE INFORMATION CONTAINED IN THIS DRAWING IS THE SOLE PROPERTY OF AMERICAN FISH ATTRACTOR AND HABITAT, LLC. ANY REPRODUCTION IN PART OR AS A WHOLE WITHOUT THE WRITTEN PERMISSION OF AMERICAN FISH ATTRACTOR AND HABITAT, LLC IS PROHIBITED.

MATERIAL
 FINISH
 DO NOT SCALE DRAWING

AMERICAN FISH TREE SODDY DAISY, TN		
TITLE: FISH CUBE XL		
SIZE B	DWG. NO. 3018	REV B
SCALE: 1:12		SHEET 1 OF 5

8 7 6 5 4 3 2 1

D
C
B
A

D
C
B
A

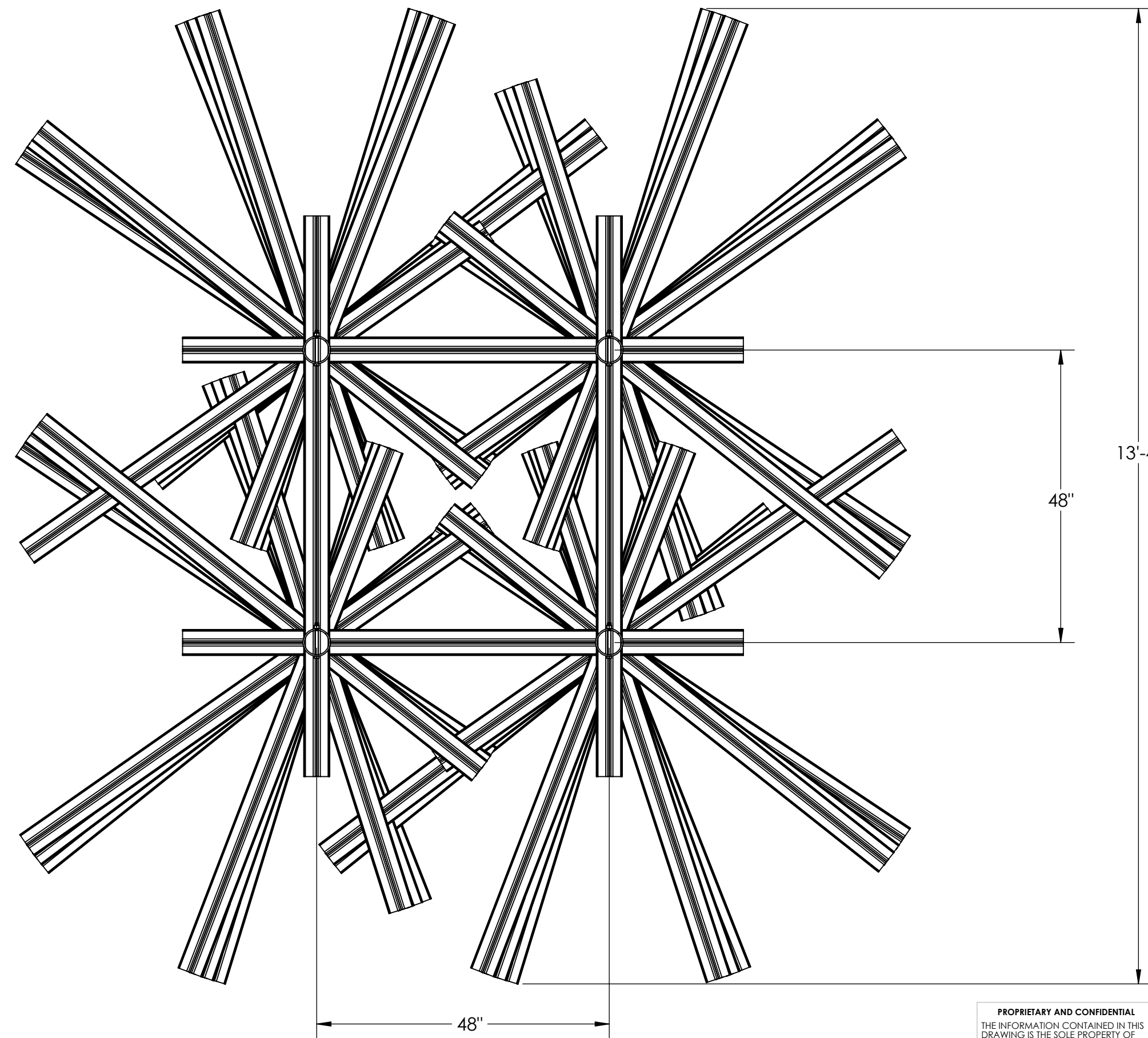

UNLESS OTHERWISE SPECIFIED:
 DIMENSIONS ARE IN INCHES
 TOLERANCES:
 FRACTIONAL ± 1/64
 ANGULAR: ± .5°
 TWO PLACE DECIMAL ± .01
 THREE PLACE DECIMAL ± .005

PROPRIETARY AND CONFIDENTIAL
 THE INFORMATION CONTAINED IN THIS DRAWING IS THE SOLE PROPERTY OF AMERICAN FISH ATTRACTOR AND HABITAT, LLC. ANY REPRODUCTION IN PART OR AS A WHOLE WITHOUT THE WRITTEN PERMISSION OF AMERICAN FISH ATTRACTOR AND HABITAT, LLC IS PROHIBITED.

MATERIAL
 FINISH
 DO NOT SCALE DRAWING

AMERICAN FISH TREE SODDY DAISY, TN		
TITLE: FISH CUBE XL		
SIZE B	DWG. NO. 3018	REV B
SCALE: 1:18		SHEET 2 OF 5

8 7 6 5 4 3 2 1

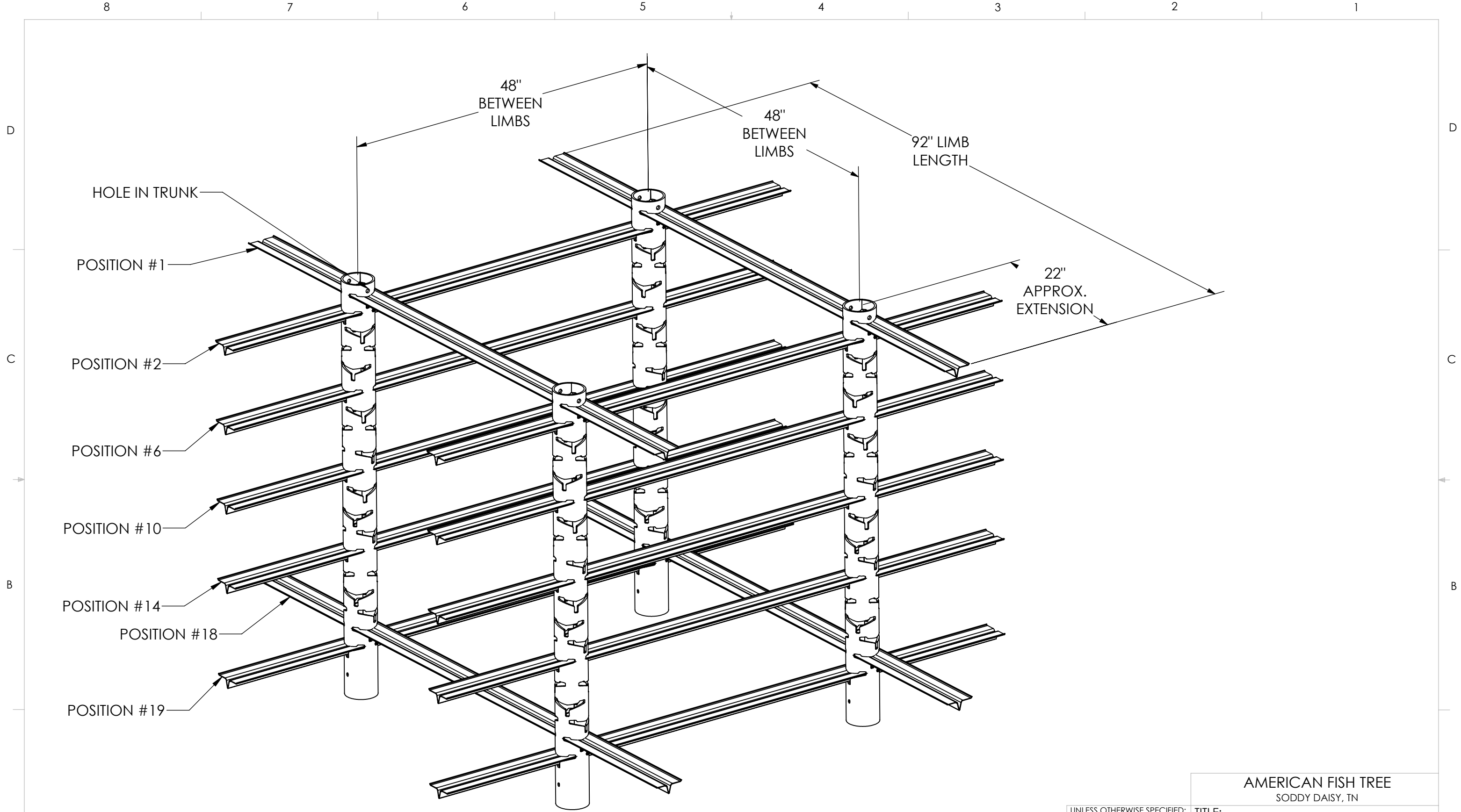

ASSEMBLY STEP #1

PROPRIETARY AND CONFIDENTIAL
 THE INFORMATION CONTAINED IN THIS DRAWING IS THE SOLE PROPERTY OF AMERICAN FISH ATTRACTOR AND HABITAT, LLC. ANY REPRODUCTION IN PART OR AS A WHOLE WITHOUT THE WRITTEN PERMISSION OF AMERICAN FISH ATTRACTOR AND HABITAT, LLC IS PROHIBITED.

UNLESS OTHERWISE SPECIFIED:
 DIMENSIONS ARE IN INCHES
 TOLERANCES:
 FRACTIONAL ± 1/64
 ANGULAR: ± .5°
 TWO PLACE DECIMAL ± .01
 THREE PLACE DECIMAL ± .005

AMERICAN FISH TREE SODDY DAISY, TN		
TITLE: FISH CUBE XL		
SIZE B	DWG. NO. 3018	REV B
DO NOT SCALE DRAWING	SCALE: 1:12	SHEET 3 OF 5

ITEM NO.	PART NUMBER	DESCRIPTION	QTY.
1	1014	FISH CUBE TRUNK 5 FT	4
2	1010	FISH ATTRACTOR LIMB 92"	62
3	92198A734	HEX BOLT 1/2-13 X 5 1/2 18-8 SS	8
4	91831A137	HEX NUT 1/2-13 NYLOK 18-8 SS	8
5	1021	CUBE TOP BRACKET	8
6	1019	TRUNK, 36" FOR 3/4 TUBE, HELIX	4
7	1009	SIL-O-FLEX SIDR 15 TUBING 3/4	64

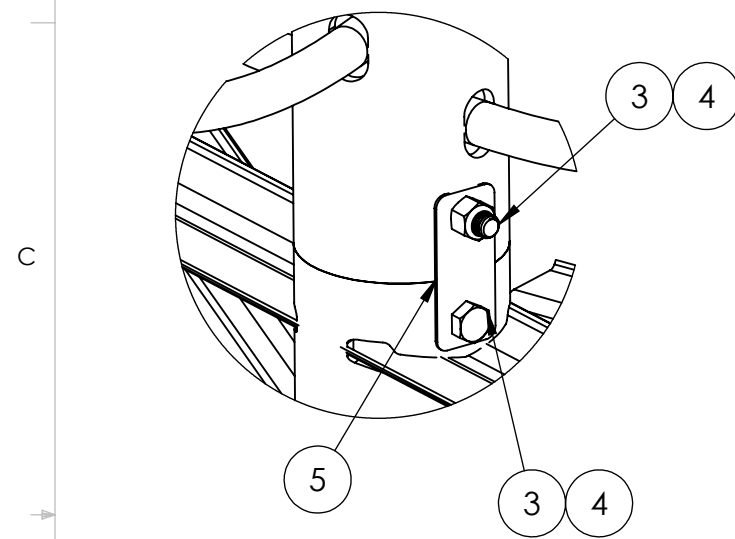

DETAIL A
SCALE 1 : 4

96"

THE SEQUOIA
OPTIONAL XL WITH TOP
3/4 TUBE TRUNK ASSEMBLY

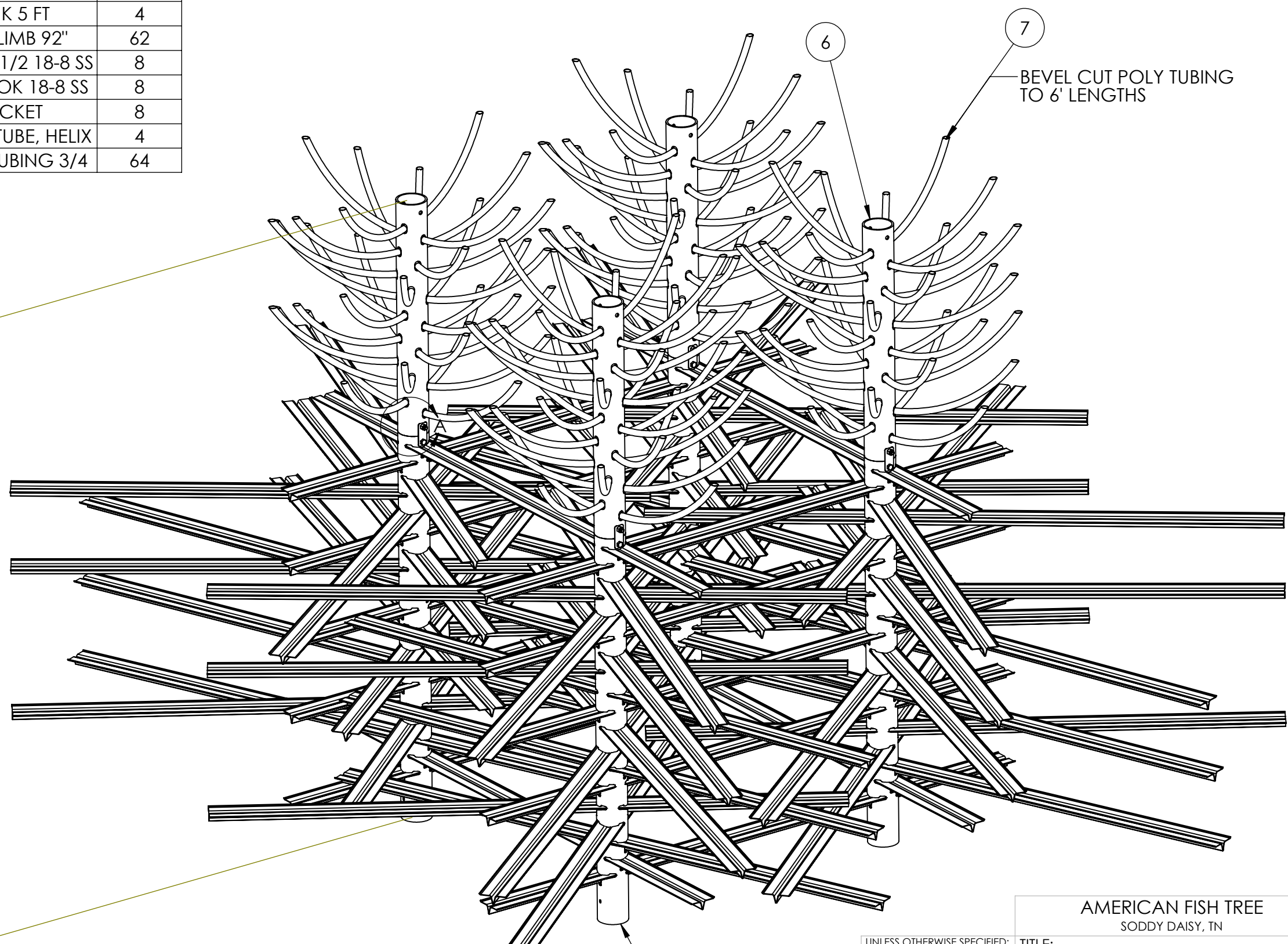

BEVEL CUT POLY TUBING
TO 6' LENGTHS

PROPRIETARY AND CONFIDENTIAL
THE INFORMATION CONTAINED IN THIS
DRAWING IS THE SOLE PROPERTY OF
AMERICAN FISH ATTRACTOR AND
HABITAT, LLC. ANY REPRODUCTION IN
PART OR AS A WHOLE WITHOUT THE
WRITTEN PERMISSION OF AMERICAN FISH
ATTRACTOR AND HABITAT, LLC IS
PROHIBITED.

UNLESS OTHERWISE SPECIFIED:
DIMENSIONS ARE IN INCHES
TOLERANCES:
FRACTIONAL ± 1/64
ANGULAR: ± .5°
TWO PLACE DECIMAL ± .01
THREE PLACE DECIMAL ± .005

AMERICAN FISH TREE
SODDY DAISY, TN

TITLE:
FISH CUBE XL SEQUOIA

SIZE B	DWG. NO. 3018	REV B
------------------	------------------	-----------------

DO NOT SCALE DRAWING SCALE: 1:16 SHEET 4 OF 5

8 7 6 5 4 3 2 1

D
C
B
A

D
C
B
A

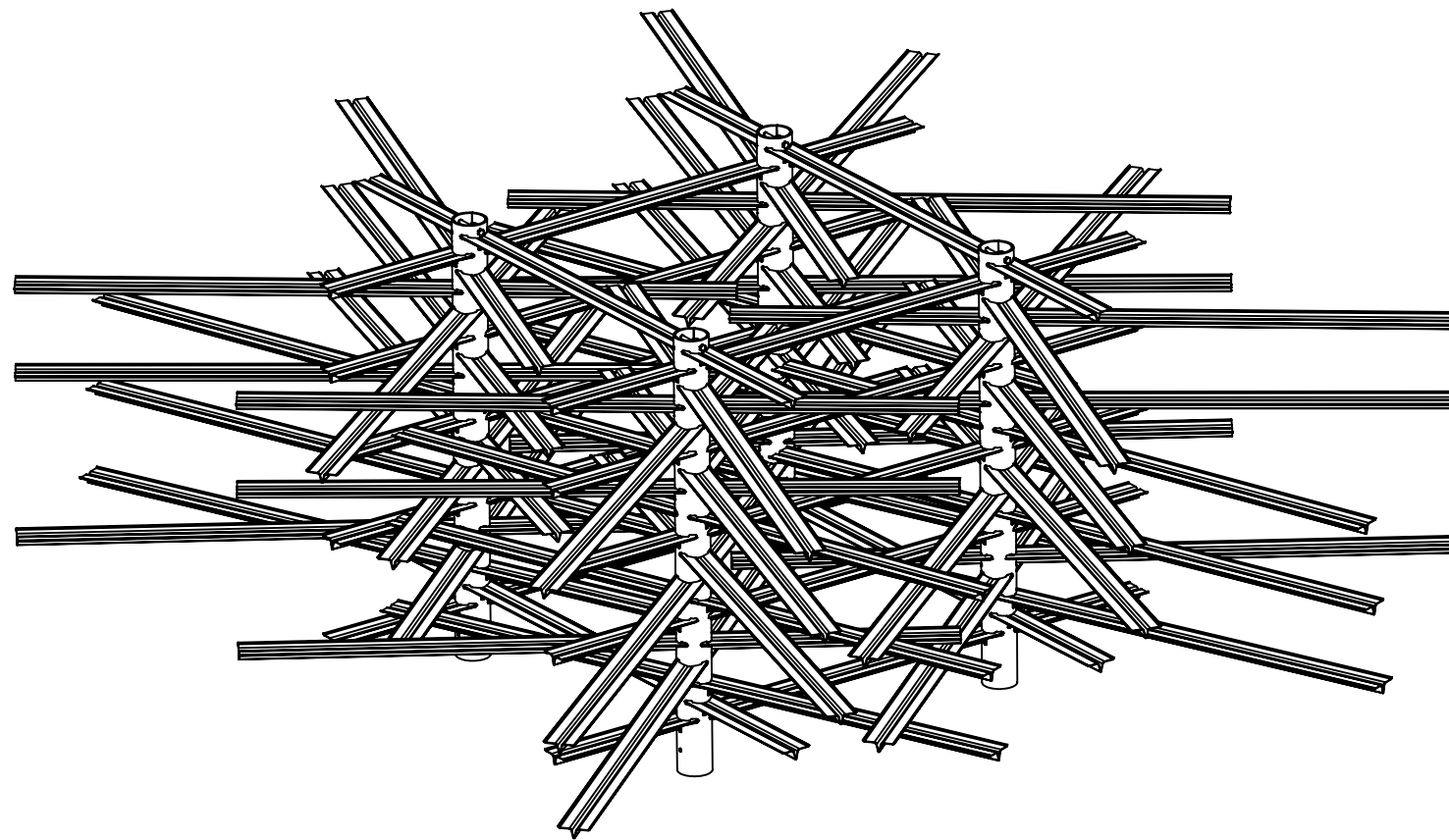

FISH CUBE XL

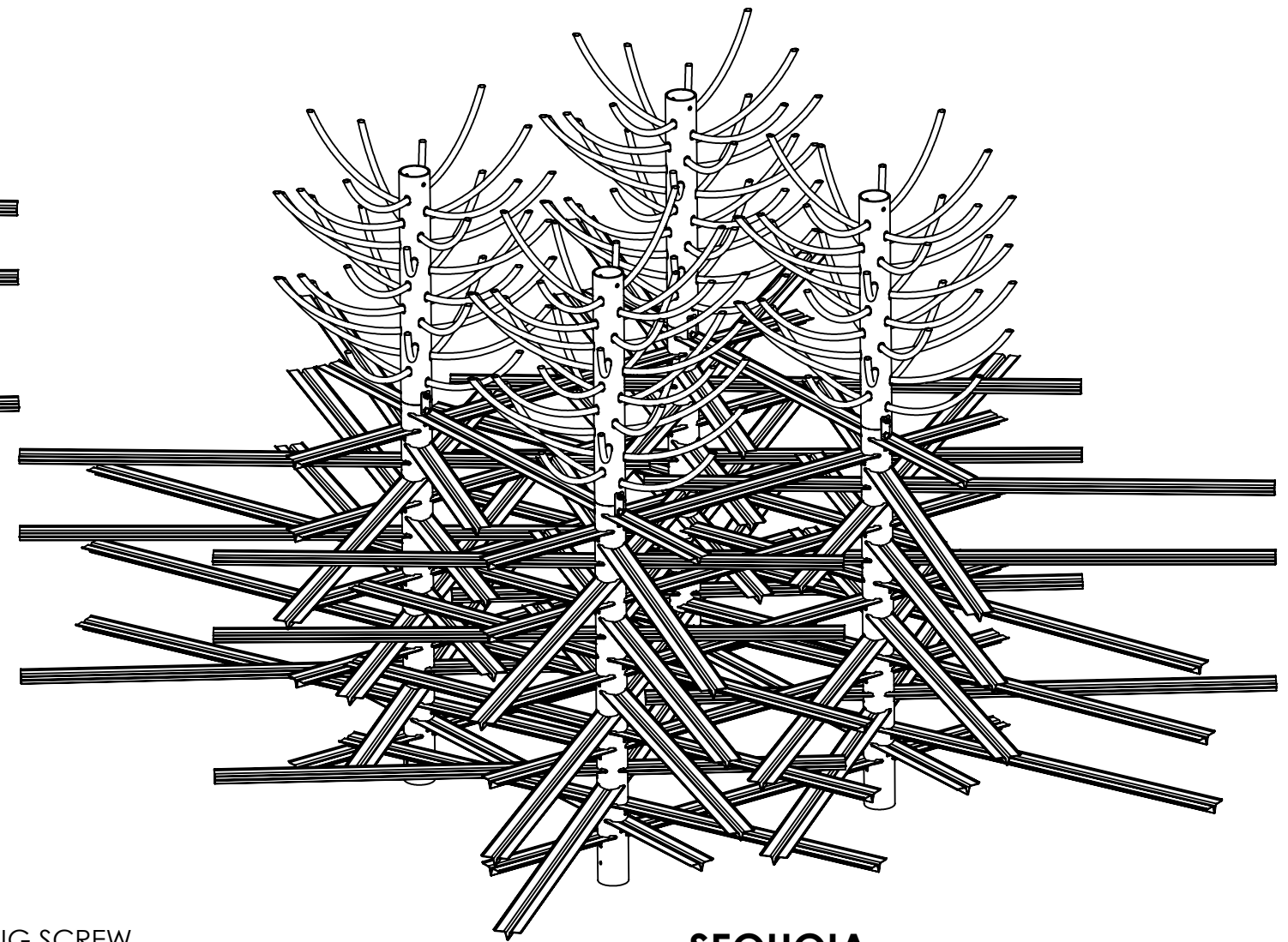

SEQUOIA

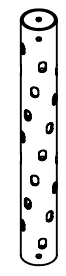

**OPTION #1
36" 3/4 TUBE TRUNK ONLY**

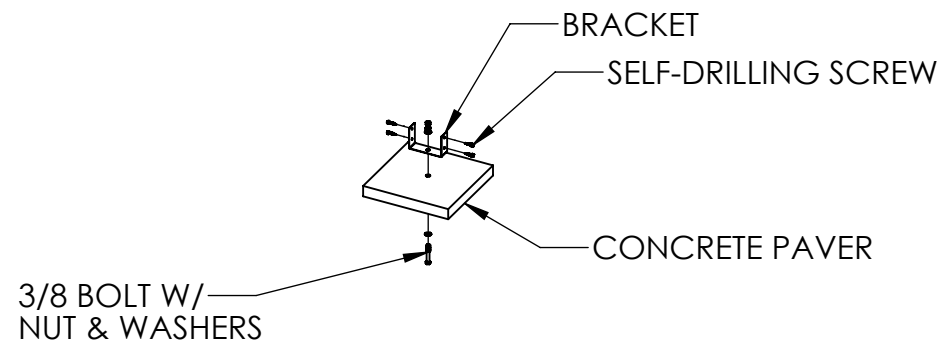

**OPTION #2
304 SS ANCHOR
BRACKET FOR
CONCRETE PAVER
STONE. PAVER NOT
INCLUDED**

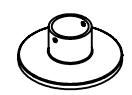

**OPTION #3
CAST IRON BASE**

PROPRIETARY AND CONFIDENTIAL
THE INFORMATION CONTAINED IN THIS DRAWING IS THE SOLE PROPERTY OF AMERICAN FISH ATTRACTOR AND HABITAT, LLC. ANY REPRODUCTION IN PART OR AS A WHOLE WITHOUT THE WRITTEN PERMISSION OF AMERICAN FISH ATTRACTOR AND HABITAT, LLC IS PROHIBITED.

UNLESS OTHERWISE SPECIFIED:
DIMENSIONS ARE IN INCHES
TOLERANCES:
FRACTIONAL ± 1/64
ANGULAR: ± .5°
TWO PLACE DECIMAL ± .01
THREE PLACE DECIMAL ± .005

AMERICAN FISH TREE SODDY DAISY, TN		
TITLE: FISH CUBE XL		
SIZE B	DWG. NO. 3018	REV B
SCALE: 1:24		SHEET 5 OF 5

8 7 6 5 4 3 2 1