

# *Favoto*

## **Favoto Fat Tire Electric Bike**



**FC CE RoHS** 

Website: [www.favoto.com](http://www.favoto.com)  
Email: [customer\\_service@favoto.com](mailto:customer_service@favoto.com)  
Phone Number: +86 18926783690  
Made in China

User Manual

## CONTENTS

SAFETY INFORMATION .....	01
GENERAL INFORMATION .....	04
TECHNICAL SPECIFICATIONS .....	09
PARTS LIST .....	09
ASSEMBLY INSTRUCTIONS .....	11
BATTERY CHARGING .....	23
OPERATION .....	26
MAINTENANCE .....	33
TROUBLESHOOTING .....	37

Thank you for purchasing this Favoto electric bike. To ensure proper use and trouble-free operation, please read this manual carefully and store it in a safe place for future reference.

## SAFETY INFORMATION

Bicycle riding involves the risk of injury and even death. Choosing to ride this e-bike means that you have taken the corresponding risks. To reduce risks and ensure your safety, you **MUST** read and follow the rules about bicycle assembly, riding, and maintenance.

### Safety Notes

- Abide by all relevant laws and regulations in your country or region when riding this e-bike. For details, please consult your relevant local authority.
- This e-bike is designed for users aged 16 to 70. We recommend users over 70 years old do not ride this e-bike. Riders must have the appropriate physical condition, reaction time, and mental capability to manage traffic, road conditions, and emergencies.
- Never operate this e-bike under the influence of alcohol, drugs, or in any other unsafe condition. Otherwise, it will impair your judgment or ability to safely operate a bicycle or other vehicles.
- If you have visual impairment, hearing impairment, physical impairment, cognitive/language impairment, epilepsy, or other conditions that may affect your safe riding, consult your physician before riding this e-bike.
- Make sure you are capable of controlling this e-bike before the first ride. Otherwise, you may lose control or fall.
- Check regularly to ensure that all components have been tightened and are in good condition.
- Make sure the handlebar is installed correctly and in good condition. A loose or damaged handlebar can cause you to lose control or fall.
- For off-road cycling, ensure that you are in an area where off-road vehicles are allowed. If allowed, wear proper safety equipment while riding and take extra care. Do not ride in remote areas.
- Do not engage in extreme riding, including but not limited to jumping, stunts, or other behaviors beyond your ability. This can damage bicycle components and cause serious injury or even death.
- Failure to perform or confirm proper installation, compatibility, operation, or maintenance of any components or accessories can result in serious injury or even death.
- Install the battery into the frame correctly. Make sure that the grooves of the battery are aligned with both linings of the battery compartment.
- Only use the charger provided. Using other chargers may cause a fire. Failure to properly charge, store, or use your battery may cause harm or danger to you or others.

- If you find any abnormal condition, stop riding immediately until you have had technicians thoroughly inspect the e-bike.
- Make sure to understand the operation of the twist power assistance and pedal assistance before each ride and travel at speeds appropriate for certain operation areas, riding conditions, and user experience. Always use the lowest assistance level until you are comfortable with this e-bike and feel confident in controlling the power.
- Check the motor cutoff switch before each ride. Make sure that when you squeeze the brake levers, the electric motor will be cut off immediately to stop the twist power and pedal assistance.
- Do not modify this e-bike in any way. Any changes may cause an unsafe riding experience. Do not remove the bell.
- Be careful to ride this e-bike in wet conditions. You should slow down the riding speed and keep a safe distance from other vehicles. Hands and feet slip more easily in wet conditions, and this could lead to serious injury or death.
- The weight limit of this e-bike is 264 lb (120 kg). Do not exceed this value.

#### Operating Rules for Safety

- Familiarize yourself with all features and operation of this e-bike. Practice and become proficient at shifting gears, applying the brakes, and using the pedal assistance and twist power assistance before each ride.
- Always wear an approved bike helmet when riding this e-bike. Riding without a helmet can result in serious injury or death.
- Wear suitable cycling clothes. If you wear loose-fitting pants, use leg clips or elastic bands to secure the bottom of your pants to prevent them from being caught by the bike chain or gears. Do not use items that may restrict hearing.
- Pay attention to road conditions, especially potholes, gravel, curbs, train tracks, speed bumps, drain gates, thorns, and broken glass.
- Be careful at intersections or when preparing to pass other vehicles or cyclists.
- Apply the rear brake first, then the front brake. If the brakes are not applied correctly, you may lose control and fall.
- Keep a safe distance away from riders, vehicles, and other objects. The safe braking distance depends on factors such as road surface and lighting conditions.



Riders should wear properly-fitted helmets that cover the forehead while riding this e-bike.

#### Wet Weather

We recommend you do not ride this e-bike in wet weather. This e-bike is not meant for use in puddles, heavy rain, or streams. Never immerse or submerge this e-bike in water or other liquids, as this may cause damage to the electrical system.

- Take extra care when riding this e-bike in wet weather.
- Reduce the riding speed in slippery conditions.
- Brake earlier as it takes longer to slow down in wet conditions than in dry conditions.
- Watch out for other road users.
- Wear reflective clothing and use approved safety lights.
- Proceed with caution. Road hazards are more difficult to perceive on a bicycle.

#### Night Riding

We recommend you do not ride this e-bike at night. If you have to ride it at night:

- Wear reflective and light-colored clothes.
- Slow down and take familiar routes with street lighting if possible.
- Make sure that all components have been tightened and are in good condition.
- Use a properly-functioning lighting set comprised of a white headlight and a red rear light.

## GENERAL INFORMATION

### Product Overview



No.	Accessory Name	No.	Accessory Name	No.	Accessory Name
①	Frame	⑪	Rear Brake	⑳	Brake Rotor
②	Battery	⑫	Derailleur	㉑	Front Fork
③	Seat	⑬	Kickstand	㉒	Front Fender
④	Seat Post	⑭	Rim	㉓	Headlight
⑤	Seat Post Clamp	⑮	Chain	㉔	Headset
⑥	Rear Light	⑯	Crank Set	㉕	Stem
⑦	Controller	⑰	Pedal	㉖	LCD Display
⑧	Rear Fender	⑱	Tire	㉗	Brake Lever
⑨	Hub Motor	㉑	Front Brake	㉘	Grip
⑩	Freewheel	㉒	Front Wheel Axle	㉙	Shift Lever

**Note:** For more details about the handlebar, please see "Getting to Know the Handlebar and LCD Display" section.

## Detailed Information

<b>Tires</b>	26 x 4" Kenda fat tires with K-Shield puncture-resistant liner	<b>Front Fork</b>	Adjustable front fork
<b>Brake Lever</b>	Aluminum alloy grip levers with motor cutoff switch and bell	<b>Throttle</b>	Half-twist throttle with on/off switch
<b>Rear Light</b>	Brake taillight	<b>Pedal</b>	Alloy pedal with reflector
<b>Freewheel</b>	Shimano freewheel with 7-speed gear	<b>Bike Frame</b>	Aluminum alloy 6061
<b>Brakes</b>	Tektro Aries brakes (7.1 in/180 mm)	<b>Front Light</b>	48 V LED light with waterproof cable
<b>Chain</b>	KMC chain	<b>Saddle</b>	VELO Plush VL6221
<b>Stem</b>	Promax MA-593S	<b>Seat Post</b>	Diameter: 1.25 in/31.8 mm Length: 13.8 in/350 mm
<b>Crank</b>	42T forged alloy (6.7 in/170 mm)	<b>Kickstand</b>	Aluminum alloy
<b>Gearing</b>	Shimano 7-speed derailleur	<b>Spokes</b>	12-gauge stainless steel

## Geometry



<b>A</b>	Total Length	77.6 in (198 cm)
<b>B</b>	Handlebar Height	45.1 in (114.5 cm)
<b>C</b>	Wheelbase	47.7 in (121 cm)
<b>D</b>	Minimum Seat Height	29.9 in (76 cm)
<b>E</b>	Maximum Height	38.2 in (97 cm)
<b>F</b>	Chain Length	26 in (66 cm)
<b>G</b>	Standover Length	29.3 in (74.5 cm)
<b>H</b>	Top Tube Length	21.7 in (55 cm)
<b>I</b>	Wheel Diameter	29.3 in (74.5 cm)
<b>J</b>	Head Tube Length	4.1 in (10.5 cm)
<b>K</b>	Handlebar Length	28 in (71 cm)

## Mandatory Requirements

Laws and regulations on e-bikes vary depending on your country and region, so make sure that you are following all laws and regulations pertaining to e-bikes specific to your region. You should have the required safety equipment and follow guidance pertaining to the use of hand signals and rules about where you are allowed to ride e-bikes.

## Assembly

Proper assembly is essential to your safety. If you do not have experience with e-bikes, or do not have the necessary tools to assemble this e-bike, we recommend that you have a certified bike mechanic to complete the assembly procedures and future adjustments. If you are an experienced user, we still recommend that you have a certified bike mechanic to check your work before your first ride.

It is critical to secure the front wheel and check whether the rear axle nuts have been tightened. Components may become loose during shipment or after use. You should check all wheel mounting hardware upon arrival as well as before each ride. Both front and rear wheels must be secured before operating your e-bike.

### Safety Check Before Each Ride

A safety check before each ride is very important to your safety and that of other road users. If you are unsure as to how to check your e-bike, please consult a professional bicycle mechanic. See more information in the “Safety Checklist” section in this manual.

- The electrical system. This electrical system provides illumination and various levels of power assistance for different operating conditions and your preferences. You should familiarize yourself with the electrical system and ensure that everything works correctly before each ride.
- The braking system. Make sure that all the components of the braking system are properly secured without any damage. When you fully squeeze the brake levers, ensure that neither of the levers touches the handlebar.
- Tires and wheels. If either wheel wobbles from side to side or up and down as it spins, please repair or replace it immediately. If a wheel comes loose after use, we recommend that you find a certified bicycle mechanic to adjust your wheel. Do not try to adjust the wheel or tighten the spokes yourself unless you have the knowledge, tools, and experience to do so.

### Quick Release Levers

Quick release levers are used to fix the front wheel and the seat post, and they allow you to remove the front wheel and adjust the seat post without the need of tools. You must check periodically to ensure that these components are secured, as quick release levers can be loosened during transportation or cycling.

### Front Fork, Handlebar, Grips, and Seat Adjustments

The front fork can affect the handling of this e-bike, so you must understand how it works before riding. You should properly adjust the front fork for your weight and the terrain. Make sure that the handlebar and the handlebar stem are properly aligned and secured. Handlebar grips should not move easily at the end of the handlebar. Loose, worn, or damaged handlebar grips should be replaced before your ride. The seat and seat post should be properly aligned, fitted to you, and the quick release lever should be properly tightened, fully closed, and secured before each ride.

## TECHNICAL SPECIFICATIONS









Technical Specifications			
<b>Hub Motor</b>	750 W Brushless Gear Motor	<b>Recommended Rider Heights</b>	5'3"-6'4" (1.6-2 m)
<b>Lithium-Ion Battery</b>	48 V 14 Ah	<b>Controller</b>	48 V 22 A
<b>Charger</b>	48 V 2 A	<b>Display</b>	LCD Display
<b>Max. Load</b>	264 lb (120 kg)	<b>Weight</b>	73 lb (33.1 kg)
<b>Range</b>	35-60 Miles (56-97 km)	<b>Pedal Assistance</b>	0-5 Level

## PARTS LIST

### Main Components

No.	Parts	Quantity
1	Front Wheel	1
2	Assembly Toolkit	1
3	Front Fender	1
4	Charger	1
5	Keys	2 (identical)
6	Headlight	1
7	Pedals	2
8	Quick Release Lever	1

## Toolkit

Tool	Picture	Quantity	Tool	Picture	Quantity
3# L-shaped Wrench		1	8/10# Wrench		1
4# L-shaped Wrench		1	13/15# Wrench		1
5# L-shaped Wrench		1	16/18# Wrench		1
6# L-shaped Wrench		1	Phillips & Flathead Screwdriver		1
9# Combination Wrench		1			

## ASSEMBLY INSTRUCTIONS

The following instructions are not intended to be an encyclopedic guide to all aspects of e-bike assembly, maintenance, and repair, but rather for general guidance. We recommend that you consult a professional bicycle mechanic to help you assemble, maintain, and repair your e-bike.

### 1. Preparing Components and Tools

Open the e-bike box and carefully remove the e-bike. Ask someone strong to help you if necessary. Carefully remove the packing materials and lay out the bicycle and other components. Please recycle packaging materials, especially the cardboard and foam. If there are any missing parts, please contact Favoto.

### 2. Installing the Handlebar onto the Stem

① Use the 4# L-shaped wrench to unscrew the 4 stem faceplate bolts. Remove the handlebar bracket.



Handlebar bracket

4# L-shaped wrench



② To place the handlebar onto the stem correctly, trace the front brake cable directly up from the front brake caliper to the left handlebar. Make sure that cables and wires around are not twisted.

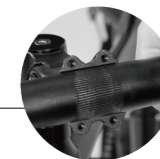

- ③ Center the handlebar, replace the handlebar bracket, and then tighten the 4 stem faceplate bolts evenly in a crisscross pattern.



- ④ To adjust the angle of the handlebar to a comfortable level and position, slightly loosen 2 stem faceplate bolts if necessary.



- ⑤ Use the 5# L-shaped wrench to loosen the Allen bolt on the side of the stem and adjust the stem angle for a better handlebar height. Make sure the handlebar grips and brake levers are roughly parallel with the ground.



Allen bolt  
5# L-shaped wrench



- ⑥ Consult a professional bike mechanic to fit the bike properly for safety, optimal fit, and bike ergonomics if necessary.

**NOTE:** Ensure the handlebar is centered on the stem and the LCD display is easily accessible to you. Hold the handlebar in place.

### 3. Installing the Front Wheel

- ① Remove wheel hub protection and the quick release lever from the front wheel.
- ② Slightly loosen the brake caliper, using the 4# L-shaped wrench if necessary. Make sure the brake pads are open before installing the front wheel.

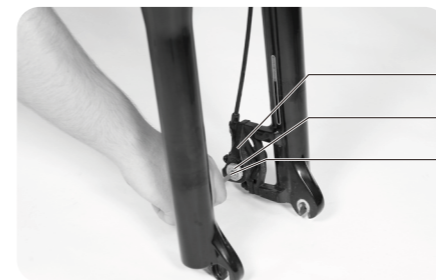

Brake pad  
Brake caliper  
4# L-shaped wrench



- ③ Insert the front wheel and carefully lower the front fork onto the axle and brake caliper. Make sure the brake rotor enters between the brake pads and the axle enters the dropouts.



Brake rotor  
Front fork  
Fork dropout



- ④ Open the quick release lever and remove the thumb nut and the cone spring, keeping the washer and the other cone spring in place on the lever side.



Quick release lever

Thumb nut

Cone spring

- ⑤ Install the lever into the front wheel axle from the opposite side of the brake rotor.



- ⑥ Place the skinny side of the cone spring into the lever and then tighten the thumb nut onto the lever using only a few turns, leaving room for the dropouts of the front fork.



Ensure the skinny side of the spring rests against the axle and the fat part of the spring rests on the inside of the thumb nut.



- ⑦ Fully insert the lever into the fork dropouts (and the brake rotor in the caliper), and then twist the lever. When there is enough resistance to keep the quick release lever aligned with the axle, close the lever.

**NOTE:** If the quick release lever does not fully clamp, open the lever again, rotate in a clockwise direction, and tighten it to the limit stop. If the quick release lever cannot be tightened to the limit stop, open the lever, make a counterclockwise rotation, and then tighten it to the limit stop.

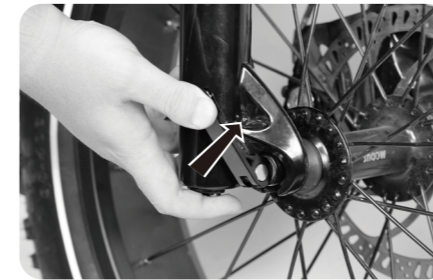

- ⑧ When properly installed, the front wheel should be at the center of the front fork, the brake rotor should be between the brake pads in the brake caliper, and the quick release lever should be fully secured.



For safety, the front wheel and quick release lever should be properly secured.



Do not touch the brake rotor, especially when the wheels and/or bicycle are in motion, as this may cause serious injuries. The natural oils from your hands can cause squeaking noise and reduce braking performance. Do not touch the brake rotor when checking, opening, or closing the quick release lever.

#### 4. Installing the Front Fender and Headlight

- ① Use the 5# L-shaped wrench and 8/10# wrench to unscrew the headlight mounting bolt set from the front fork.
- ② Place the fender, starting from the back of the front tire, and position it under the front fork.



- ③ Use the 4# L-shaped wrench to loosen the Allen bolt on the headlight to adjust the angle.

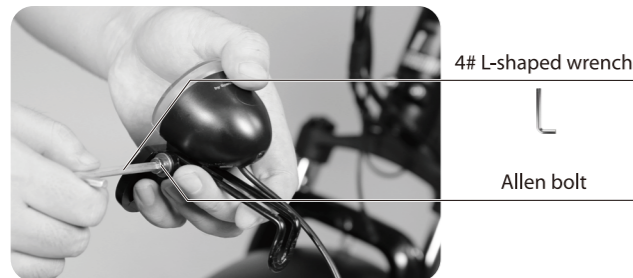

- ④ Attach the headlight and fender to the fork. Pass the headlight mounting bolt through the headlight mount, the fender mounting hole, the fork arch mounting hole, a large washer, and thread the locknut onto the bolt end.

- ⑤ Tighten the bolt with the 5# L-shaped wrench while holding the locknut with the 8/10# wrench.



- ⑦ Attach the fender mounting arms to the front fork. Ensure the fender is centered and tighten all mounting bolts. Ensure that the fender clamps on both sides are parallel with each other.



- ⑥ Remove the mounting bolt from the fender mounting arms with the 5# L-shaped wrench.



- ⑧ Use the 4# L-shaped wrench and the 8/10# wrench to tighten the Allen bolt. Then, tilt the headlight to the best position and tighten it firmly.

- Locate the 2 sides of the red two-pin headlight connector, carefully align the inner pins and notches with the outer arrows, and then press them directly together without twisting to completely secure the connection.



## 5. Installing the Pedals

- Know which pedal is marked with a "WR" or "WL" at the pedal axle end. "WR" refers to the right pedal and "WL" the left pedal.
- Carefully thread each pedal onto its appropriate crank set.
- Turn the right pedal clockwise with the 16/18# wrench, and turn the left pedal counterclockwise. Do not damage, strip, or cross threads.

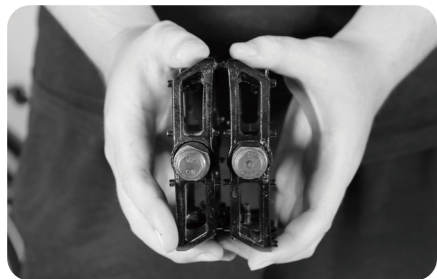

16/18# wrench



## 6. Inflating the Tires

- Check whether the tire bead and tire are evenly positioned on the rim.
- Use a pump with a Schrader valve and pressure gauge to inflate each tire to the recommended pressure, indicated on the tire sidewall, of 20-30 PSI (1.4-2.1 BAR). Do not overinflate or underinflate the tire.



Schrader valve



## 7. Setting the Desired Seat Height

Depending on your preference, ability, and experience in bicycles and electric bikes, lower the seat so that you can place one or both feet on the ground without having to get off of the seat. This may provide a safer and more comfortable experience when operating this e-bike.

For maximum comfort, you should not overstretch your arms while riding. We recommend that the handlebar and brake lever angle allow for a comfortable arm position and straightness of the forearm, wrist, and hand. Make sure the handlebar angle is adjusted so that the handlebar does not touch your body when turning. You should consult a certified bicycle mechanic to ensure that you have a good fit.

Proper seat height is attained when your foot can make full contact with the pedal when the pedal is at its lowest position. Your legs should be able to stretch almost completely without fatigue from over stretching. Your hips should not swing from side to side when pedaling.

### **To adjust the seat height:**

- ① Open the seat post clamp.



- ② Move the seat up or down by sliding the seat post in or out to the desired seat height. Do not exceed the minimum line. Ensure that the minimum insertion markings on the seat post are inside the frame.



Allen bolt

- ③ If necessary, tighten the adjustment nut (opposite the seat post clamp) to secure the seat post. Close the seat post clamp fully and ensure that the seat cannot move up, down, left, or right.



Before using this e-bike, always check to ensure all bolts, nuts, and quick release levers are properly secured and undamaged. Check that they are correctly secured before each ride. Otherwise, the handlebar post and/or the seat post may come loose and can result in loss of control, damage to the bike/property, serious injury, or death.

### **8. Adjusting the Seat Position and Angle**

- ① Use the 6# L-shaped wrench to loosen the seat adjustment bolt underneath the seat.
- ② Once the bolt is loose, rotate the front of the seat to adjust the angle of the seat.
- ③ Move the seat backwards or forwards within the white limit markings on the seat rail, which show the minimum and maximum horizontal movement of this component. Do not exceed these limits.
- ④ While holding the seat in the desired position, use the 6# L-shaped wrench to tighten the seat adjustment bolt securely.

**NOTE:** Prior to the first use, be sure to properly tighten the seat adjustment bolt. A loose seat adjustment bolt can cause bike/property damage, loss of control, a fall, serious injury, or death. Periodically check to make sure that the seat adjustment bolt is properly tightened.

### **9. Adjusting the Front Fork**

The front fork can serve as a shock absorber to minimize the impact of small obstacles, such as potholes or rocks on the road or trail. It has 2 control mechanisms to allow you to tune your riding experience to your style: the lockout and pre-load adjustment knob.

The front fork can move up or down up to 3.14 in (80 mm) to help cushion bumps on the riding surface, which can make riding on a rough road or trail smoother and more enjoyable. Depending on your preference, the front fork can be locked out as a rigid fork, which will typically yield higher pedaling efficiency.

### **Lockout knob**

The lockout knob is located on the top of the front fork (on the rider's right side). Turn the lockout knob counterclockwise until it stops, and the knob will cause the fork to be rigid and completely lock the fork's motion. To unlock the fork's motion, turn the knob clockwise until it stops.

### **Pre-load adjustment knob**

The pre-load adjustment knob is located on the top of the front fork (on the rider's left side). Use the pre-load adjustment knob to select the level of stiffness in the fork, as long as it is not locked out as a rigid fork.

#### **To adjust the pre-load:**

- ① Make sure the lockout knob is unlocked.
- ② Turn the pre-load adjustment knob clockwise toward the "+" to stiffen (add resistance) or counterclockwise toward the "-" to soften (reduce resistance).



### **10. Checking the Battery Before Each Ride**

- ① Check that the battery is locked into the frame before each ride.
- ② Operate the electrical system when the battery is fully charged and secured in the frame.

### **11. Reviewing the Remainder of the Manual**

After assembling this e-bike according to the above instructions, please read, understand, and follow the steps outlined in the rest of this manual before operating this e-bike. If you have any questions about the assembly of this e-bike, please contact Turboant. If you are not sure that all the assembly steps in the assembly video have been performed correctly, or if you are unable to view the assembly video, in addition to contacting Favoto for assistance, consult your local certified bicycle technician for help.

## **BATTERY CHARGING**

### **Charging Information**

- Check the charger, charger cable, and battery for damage before each charge. Charge at a temperature ranging from 50 °F -77 °F (10 °C to 25 °C).
- Charge indoors. Keep the battery in a cool and dry place, away from direct sunlight, dirt, and debris.
- The battery should be recharged after each ride. It usually takes 3-7 hours to be fully charged. The 4 LED lights indicate the battery level. Press the battery indicator button. GREEN means the battery has adequate battery power, and RED means the battery needs charging. Charging time depends on a variety of factors, including cycling distance, terrain, payload, and battery life.

**NOTE:** It may take longer to recharge before the first ride, after the battery is completely depleted, or after 3 to 5 years of use. If the battery does not show normal charging, if the charging time is longer than expected, or if your cycling distance becomes significantly reduced, please stop riding this e-bike and contact Favoto.

- Do not charge for more than 12 hours straight. Never leave a charging battery unattended.
- Failure to follow the best battery charging principles may cause unnecessary wear and tear to the charging components, batteries and/or chargers, and may result in poor battery performance or battery failure.
- When installing the battery on this e-bike, do not force the battery onto the frame. Be careful when aligning the battery with the frame. Make sure that the battery is locked and secured to this e-bike before each use.



When the battery is charged, the charging indicator will show RED. When fully charged, the indicator turns GREEN. Make sure the indicator is lit when charging. When the indicator turns GREEN, please remove the charger within 1 hour to avoid unnecessary loss of charging components.



Handle the battery carefully, and do not let it fall or become damaged. Do not touch or damage the + and - terminal contacts at the bottom of the battery. Keep them away from debris. Do not turn on the battery if you are riding your bike without it, or you may damage the electrical system.



Avoid damage to battery connector terminals, which are exposed when the battery is unlocked or removed from the frame. In case of damage to the terminals or battery mounts, please stop riding your bike and contact Favoto immediately.

### Charging Procedure

The battery can be charged in the frame or when it is disconnected from the frame.

#### **When the battery is in the frame:**

- ① Turn off e-bike.
- ② Locate the charging port on the right side of the frame and remove the rubber protective cover.
- ③ Plug the charger into the charging port and connect it to a power outlet (120 V AC, 47-63 Hz).



#### **When the battery is disconnected from the frame:**

- ① Unlock the battery by turning the key counterclockwise. Keep turning the safety knob clockwise and take out the battery from the frame.
- ② Open the rubber cover at the bottom of the battery and locate the charging port. Charge the battery using a power outlet in a safe place (120 V AC, 47-63 Hz).
- ③ Reinsert the battery starting with the bottom end. Lock the battery by turning the key clockwise.



#### **NOTES:**

- The LED displays the charging status. RED means the battery is in the charging process and GREEN means it is fully charged. Charge at a temperature ranging from 50 °F -77 °F (10 °C to 25 °C).
- Make sure the battery and charger are not damaged before charging. If you find anything abnormal during charging, please stop charging or operating and contact Favoto for help.
- Be sure to lock the battery into the battery compartment with the key after installing the battery. Otherwise, damage or harm to the user may occur.

#### **Charger Safety Information**

- Charge indoors on flat, stable, and hard floors in a cool, dry, and ventilated environment.
- Charge it at a temperature ranging from 50 °F -77 °F (10 °C to 25 °C).

- Avoid contact with any liquid, dirt, debris, or metal objects. Do not cover the charger when in use.
- Store the charger in a safe place and away from children.
- Fully charge the battery before each use to ensure maximum performance, extend the life of the battery, and reduce excessive discharge.
- Only use the charger provided. Do not use other chargers.
- This charger works on 120 V AC, 47 Hz-63 Hz standard home AC power outlets and automatically detects and accounts for incoming voltage. Do not open the charger or modify the voltage input.
- Do not yank or pull on the cables of the charger. When unplugging, carefully remove both the AC and DC cables by pulling on the plastic plugs directly, not by pulling on the cables.
- The charger may become hot when operating as designed. If the charger becomes too hot or generates any strange smell, stop charging immediately and contact Favoto.
- This battery can only be charged using the charger provided, designed for your specific e-bike serial number. Do not use any other charger, as it may cause damage, serious injury, or death.
- Follow the detailed procedures and safety information in this manual and take special care when charging your e-bike. Failure to follow proper charging procedures may result in damage to bicycles, chargers, or personal property, and/or serious personal injury, or death.

### Long-Term Battery Storage

If you want to store your e-bike for more than 2 weeks, follow the instructions below to keep your battery in good condition.

- Charge the battery to approximately 75%.
- Power off the battery and leave it locked to the frame. Alternatively, you can unlock it and remove the battery from the frame for storage.
- Store the battery in a dry, climate-controlled, and indoor location where the temperature is between 50 °F-77 °F (10 °C-25 °C).
- Check on the battery every month, and if necessary, use the charger we provide to charge the battery to 75%.

## OPERATION

Read and understand the following steps thoroughly before you operate this e-bike. It is very important for your safety and that of other road users. You must familiarize yourself with the twist power-assistance mechanism, the pedal assistance mechanism, and the derailleur mechanism. Safety notes and warnings **MUST** be followed to prevent damage to your e-bike, accidental injuries, and even death. If you have any questions about operation, please contact Favoto.

## Getting to Know the Handlebar and LCD Display

### Handlebar

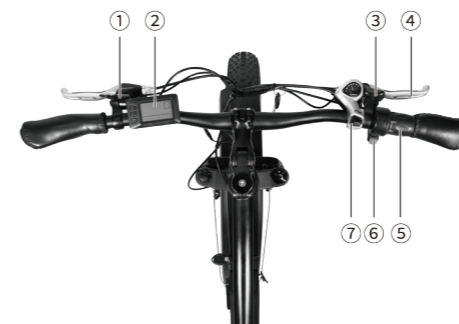

- |               |                     |
|---------------|---------------------|
| ① Bell        | ⑤ Throttle          |
| ② LCD Display | ⑥ Throttle Switch   |
| ③ Shift Lever | ⑦ Derailleur Button |
| ④ Brake Lever |                     |

### LCD Display

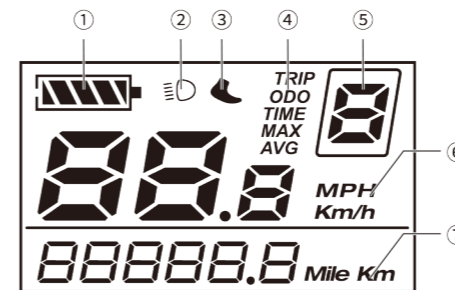

- |                        |                          |
|------------------------|--------------------------|
| ① Battery Level        | ⑤ Pedal Assistance Level |
| ② Light On/Off         | ⑥ Speed                  |
| ③ Push-Assistance Mode | ⑦ Trip Distance          |
| ④ Function List        |                          |

### Display Interface

After turning on the e-bike system, the LCD will display Speed and Trip Distance by default. Press the power button to switch between the following screens:

Current Speed (MPH) → Trip Distance (Mile) → Trip Time (Minute) → Max. Speed (MPH) → Avg. Speed (MPH) → Current Speed (MPH).

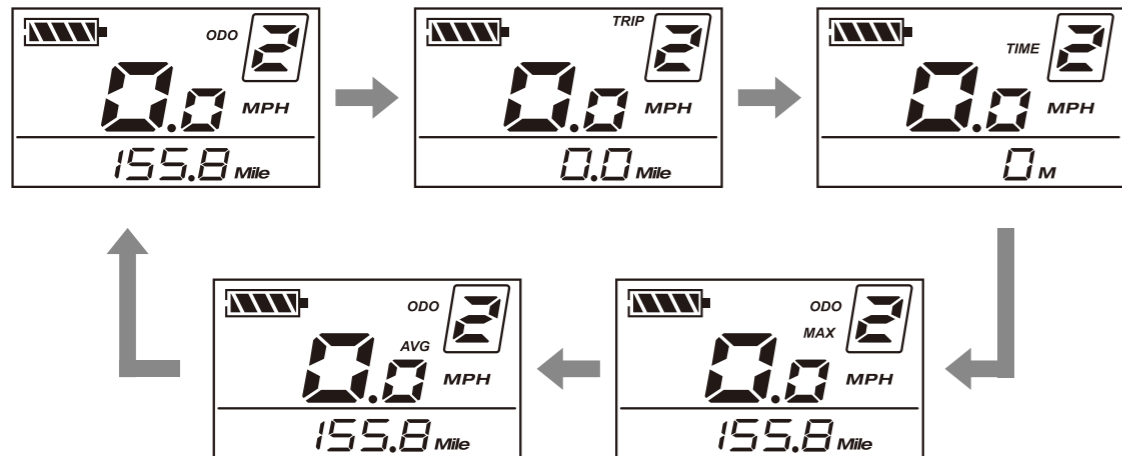

### Turning the E-Bike System On/Off

- Hold down the power button for 3 seconds to turn on the e-bike system.
- After turning on the e-bike system, the LCD will display Speed and Trip Distance by default. Press the power button to switch between the various screens.
- If the e-bike is left unattended for more than 10 minutes, it will automatically turn off.

### Trip Distance Clearing & Backlight Settings

- Press the and button simultaneously to enter the setting interface for trip distance clearing. Press the or button to choose Y or N. The default setting is N. Hold down the power button to exit.

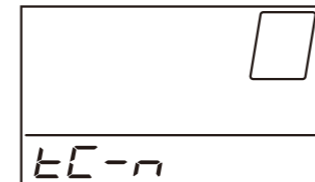

- Press the power button to save the settings and enter the backlight options page. Press the or button to adjust the backlight brightness. The brightness has 3 levels, with Level 1 referring to the dimmest setting. The default setting is Level 1.

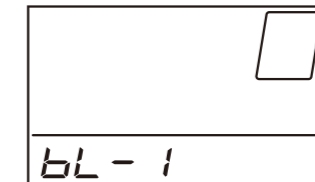

### Switching Push-Assistance Mode On/Off

- To activate the push-assistance function, hold the button for 3 seconds. The e-bike will activate at speeds lower than 3 mph (5 km/h) while the screen displays . Only use this function when pushing the e-bike.
- Push-assistance function is switched off as soon as you release the button, and the e-bike system will stop power output immediately.



Keep at least one hand on a brake lever to allow quick cutoff of the motor and to maintain control of this e-bike.







### Using the Twist Power Assistance Function

- Press the red button to start the twist power assistance. Gently twist the throttle to increase or decrease the speed.
- Release the throttle to stop the twist power assistance. Press the red button again to stop this function.



To avoid accidental application of the twist power assistance, ensure that the red button isn't pressed down and that the bike is powered off.

### Using the Pedal Assistance Function

- Press the  or  button to switch between assistance levels (motor power levels). The assistance level ranges from Level 0 to Level 5. Level 0 is zero power, Level 1 minimum power, and level 5 maximum power.
- If you press the  button after already reaching Level 5, the LCD display will still show 5, indicating the power has already reached its maximum.
- If you press the  button after already reaching Level 0, the LCD display will still show 0, indicating it has reached its minimum. The default level is Level 1.



**NOTE:** Even if you are an experienced bike user, you need to read this manual carefully and follow the rules.

### Adjusting the Rear Derailleur

- The rear wheel contains 7 chain sprockets. When the chain is around the largest sprocket, the e-bike is in Gear 1, the lowest gear.

- To adjust the derailleur gear, press the derailleur button. Each time you press the button, the e-bike will increase by one gear.
- Manually press the shift lever to decrease gears.

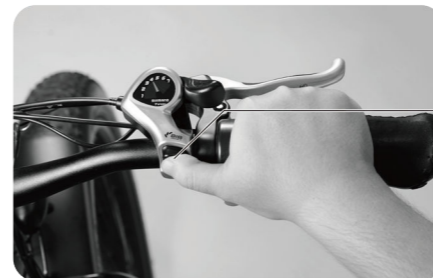



Derailleur button



Shift lever

**NOTE:** Only shift gears when pedaling. Do not change multiple gears in rapid succession. If you shift gears too fast, the chain may fall off the sprocket.

### Switching the Front and Rear Lights On/Off

- Hold down the  button for 3 seconds, and the front and rear lights will light up and the icon  will show on the LCD display.
- Press the brake levers, and the rear light will flash.
- Hold down the  button for 3 seconds to switch off the lights.

### Battery SOC Indicator

The battery strip represents the current battery capacity. When the battery is low, it needs to be recharged immediately.

### Driving Distance

The cruising range of the bicycle refers to the distance remaining in a single ride when the e-bike is fully charged. Some factors that affect this range include altitude, speed, payload, acceleration, temperature, tire pressure, and terrain. We recommend that you choose a lower assistance level when buying a bike from Favoto for the first time to learn about your e-bike and travel routes.

## Bicycle Load

The weight limit of this e-bike is 264 lb (120 kg). Do not exceed this value.

Bicycle loading involves additional risks and requires your special care, as loads will affect braking, steering, acceleration, and balancing. Once the bicycle is loaded, riding can become challenging and dangerous. For your safety, you need to get used to the operation of braking, steering, acceleration, and balance when your bicycle is loaded. You should practice riding with loads on a flat and open field. Start with lighter loads before loading heavy goods.

### NOTES:

- You **must** hold onto this e-bike while riding it.
- The e-bike may fall over when it is loaded, even when the kickstand is engaged.
- Ensure that your load is properly secured, and check periodically to ensure that nothing loosens or risks interfering with any moving components, touching or dragging on the ground.
- Become proficient at controlling the e-bike with goods in a flat and open area before riding on roads or hills. Know your limits and plan routes accordingly.



We recommend using the rear brake first and then the front brake. Braking with only the front brake can put excessive pressure on components, damage the e-bike and components, and/or cause you to lose control.

It is always the user's responsibility to ensure that the goods loaded on the e-bike do not affect the user's ability to safely operate the electric bicycle. If the user's ability to safely operate the electric bicycle is affected by goods on the bike, it may cause serious personal injury or death.

## Parking, Storage, and Transportation

Follow these basic tips for parking, storage, and transportation to ensure that your bike is well kept both on and off the road.

- Turn off the power to avoid accidental acceleration of the motor when pushing or carrying the e-bike manually. Turn the power and any lights off to conserve battery life.
- Make sure that the battery is locked into the frame when the power is off or use the key to remove the battery and bring it with you for safety.
- Park indoors if possible. If you have to park outdoors in wet and rainy conditions, you should only leave it outside for a few hours, and then let it dry out indoors. E-bikes in humid environments require more frequent maintenance to prevent rust and corrosion.
- Do not park, store, or transport your e-bike on a rack not designed for the bike's size and weight.
- Remove the battery first when storing the bicycle or when placing it on a rack for transportation. This can reduce the weight of the bicycle and make lifting and loading easier.
- Avoid transporting e-bikes on a rack when it rains, as this can cause water damage to electronic components.
- It is advisable to lock up your bike to prevent theft.

## MAINTENANCE

Please follow these listed rules and contact a certified bicycle mechanic regularly to ensure that your e-bike is safe and comfortable to ride. For more detailed information, see "Recommended Service Intervals" and "Safety Checklist" in this manual.

- Keep the battery to approximately 75% charged when it has not been used for over 2 weeks. See more information in the "Long-Term Battery Storage" section.
- Do not immerse this e-bike or any other components in any liquid, as this may cause damage to the electrical system.
- Check wires and connectors regularly to ensure that the connectors are secured and undamaged.
- Clean this e-bike with a damp cloth and dry it with a clean dry cloth. If necessary, clean the frame by applying a mild, non-corrosive detergent mixture to a damp cloth.
- Do not expose this e-bike to rain or any other corrosive materials. Once exposed to rain, it should be dried. The chain and other unpainted steel surfaces should be treated with rust protection.
- Be careful when cycling on beaches or coastal areas, as salt can corrode your e-bike. Keep the unpainted parts clean and rust-proof.

- If the paint on the metal is scratched or chipped, use a patch to prevent it from rusting. Clear nail polish can also be used as a backup.
- Clean and lubricate all moving components regularly, and tighten and adjust them as required. Check all hardware periodically to make sure they are securely connected and working well.

#### Recommended Service Intervals

Interval	Inspect	Service	Replace
Weekly 62.5-187.5 Miles (150-300 km)	<ul style="list-style-type: none"> <li>• Check that hardware is installed correctly.</li> <li>• Check that the drivetrain is in position and working properly (including chain, freewheel, chain link, and derailleur).</li> <li>• Check wheel alignment and quiet wheel operation (no spoke noise).</li> <li>• Check the frame for any damage.</li> </ul>	<ul style="list-style-type: none"> <li>• Clean the frame with a damp cloth.</li> <li>• Use a wrench to tighten the transmission/brake cable if needed.</li> </ul>	<ul style="list-style-type: none"> <li>• Replace any components confirmed by favoto.</li> </ul>
Monthly 220-750 Miles (350-1200 km)	<ul style="list-style-type: none"> <li>• Check brake pad alignment and brake cable tension.</li> <li>• Check for proper bike shifting and derailleur cable tension.</li> <li>• Check chain tension.</li> <li>• Check brake and shift cables for corrosion or fraying.</li> <li>• Check spoke tension.</li> <li>• Check accessory mounting (fender hardware).</li> </ul>	<ul style="list-style-type: none"> <li>• Clean and lubricate the drivetrain.</li> <li>• Check the crank set and pedals.</li> <li>• Clean brake and shift cables.</li> <li>• Align and tension wheels if any loose spokes are discovered.</li> </ul>	<ul style="list-style-type: none"> <li>• Replace brake and shift cables if necessary.</li> <li>• Replace brake pads if necessary.</li> </ul>
Every 6 Months 750-1300 Miles (1200-2080 km)	<ul style="list-style-type: none"> <li>• Inspect the drivetrain (chain, chainring, freewheel, and derailleur).</li> <li>• Inspect all cables and housings.</li> </ul>	<ul style="list-style-type: none"> <li>• Tune-up by a certified bike mechanic.</li> <li>• Lubricate the bottom bracket.</li> </ul>	<ul style="list-style-type: none"> <li>• Replace brake pads.</li> <li>• Replace tires if necessary.</li> <li>• Replace cables and housings if necessary.</li> </ul>

#### Safety Checklist

We recommend you follow this safety checklist before each ride or after every 20-50 miles (32-80 km).

Safety Check	Steps
Brakes	<ul style="list-style-type: none"> <li>• Ensure the front and rear brakes work properly. Check brake pads for wear.</li> <li>• Ensure the brake pads are correctly positioned and aligned with the brake rotor.</li> <li>• Ensure brake cables are lubricated and properly adjusted without wear.</li> <li>• Ensure that brake levers are lubricated and tightly secured to the handlebar.</li> <li>• Ensure the brake levers are firm and that the brake and the brake light are properly functioning.</li> </ul>
Tires and Wheels	<ul style="list-style-type: none"> <li>• Ensure that tires are inflated within the recommended limits posted on the tire sidewalls.</li> <li>• Ensure that tires have no bulging, excessive wear, or any other damage.</li> <li>• Ensure that rims run well without any obvious wobbles, dents, or kinks.</li> <li>• Ensure that wheel spokes are tight and not broken.</li> <li>• Check axle nuts and the quick release lever of the front wheel to ensure that they are tight.</li> <li>• Ensure that the quick release lever is fully closed and secured.</li> </ul>
Steering	<ul style="list-style-type: none"> <li>• Ensure that the handlebar and stem allow proper steering and are correctly adjusted and tightened.</li> <li>• Ensure that the handlebar is set correctly in relation to the front fork and the riding direction.</li> </ul>
Chain	<ul style="list-style-type: none"> <li>• Ensure that the chain is clean, oiled, and runs smoothly.</li> <li>• Extra care is required in wet, salty, corrosive, or dusty conditions.</li> </ul>
Bearings	<ul style="list-style-type: none"> <li>• Ensure that all bearings are lubricated, run freely, and display no excess movement, grinding, or rattling.</li> <li>• Check headset, wheel bearings, pedal bearings, and bottom bracket bearings.</li> </ul>
Cranks and Pedals	<ul style="list-style-type: none"> <li>• Ensure that pedals are securely tightened to the cranks and the cranks are securely tightened, not bent.</li> </ul>

Derailleur and Mechanical Cables	<ul style="list-style-type: none"> <li>• Check to make sure that the derailleur is adjusted and functioning properly.</li> <li>• Ensure shifter and brake levers are attached to the handlebar securely.</li> <li>• Ensure that all shifter and brake cables are properly lubricated.</li> </ul>
Frame, Fork, and Seat	<ul style="list-style-type: none"> <li>• Check to make sure that the frame and fork are not bent or broken. If the frame or fork is bent or broken, it should be replaced.</li> <li>• Check that the seat is adjusted properly and the quick release lever of the seat post is securely tightened.</li> </ul>
Motor Drive Assembly and Twist Power Assistance	<ul style="list-style-type: none"> <li>• Ensure that the hub motor is spinning smoothly and the motor bearings are in good working condition.</li> <li>• Ensure that all power cables running to the hub motor are secured and undamaged.</li> <li>• Make sure that the hub motor axle bolts are secured with the torque arm and torque washers in place.</li> </ul>
Battery	<ul style="list-style-type: none"> <li>• Ensure that the battery is charged and without damage before each ride.</li> <li>• Lock the battery into the frame and ensure that it is secured.</li> <li>• Charge and store the bike in a dry location with a temperature between 50 °F-77 °F (10 °C-25 °C).</li> <li>• If wet, let the bike dry completely before using it again.</li> </ul>
Electrical Cables	<ul style="list-style-type: none"> <li>• Look over connectors to make sure they are fully seated and free from debris or moisture.</li> <li>• Check cables and cable housings for obvious signs of damage.</li> <li>• Ensure that the headlight is functioning, adjusted properly, and not obstructed.</li> </ul>
Accessories	<ul style="list-style-type: none"> <li>• Ensure that all other fittings on the e-bike are properly secured and functioning.</li> <li>• Wear a helmet and other required riding safety gear. Inspect your helmet and other safety gears for signs of damage.</li> <li>• Ensure that the mounting hardware is secured when fitted with a front rack, a rear rack, the basket, etc.</li> <li>• Ensure that the taillight and taillight power wires are properly secured when fitted with the rear rack.</li> <li>• Ensure that the fender mounting hardware is properly secured with no cracks or holes in the fenders.</li> </ul>

### Tire Inflation and Replacement

This e-bike uses 26" x 4.0" rubber tires, which are safe for regular riding. Check their inflation level before each ride. Correct inflation, maintenance, and timely replacement can ensure that your electric bicycle functions properly. We recommend 20-30 PSI/1.4-2.1 BAR for both front and rear tires.

It is essential to maintain proper air pressure in the tire at all times. Do not underinflate or overinflate tires. Low pressure can cause losing control, and over-inflated tires can burst. Failure to always maintain the air pressure level indicated on the tire sidewall may cause tire and/or wheel failure. Inflating a tire from an unregulated air source can overinflate the tire, which can cause the tire to burst.

Even tires equipped with built-in flat-preventative tire liners can get flats from punctures, pinches, or other causes. When tire wear becomes evident or a flat tire is discovered, you must replace the tires and/or tubes before operating this bike, or injury to operators and/or damage to your bike may occur.

When changing a tire or tube, ensure that all air has been removed from the inner tube before removing the tire from the rim. Failure to remove all air pressure from the inner tube could result in serious injury, unsafe riding conditions, or damage to your bike.

### TROUBLESHOOTING

Please follow these listed rules and contact a certified bicycle mechanic regularly to ensure that your e-bike is safe and comfortable to ride. For more detailed information, see "Recommended Service Intervals" and "Safety Checklist" in this manual.

Problems	Possible Causes	Common Solutions
The e-bike does not work	<ul style="list-style-type: none"> <li>① Insufficient battery power</li> <li>② Faulty connection</li> <li>③ Battery not fully seated in the frame</li> <li>④ Improper turn-on sequence</li> <li>⑤ Blown 40a discharge fuse</li> </ul>	<ul style="list-style-type: none"> <li>① Charge the battery</li> <li>② Clean and repair connectors</li> <li>③ Install battery correctly</li> <li>④ Turn on the e-bike in proper sequence</li> <li>⑤ Replace 40a discharge fuse</li> </ul>

Irregular acceleration and/or reduced top speed	<ul style="list-style-type: none"> <li>① Insufficient battery power</li> <li>② Loose or damaged twist power assistance</li> <li>③ Misaligned or damaged magnet ring</li> </ul>	<ul style="list-style-type: none"> <li>① Charge or replace the battery</li> <li>② Replace twist power assistance</li> <li>③ Align or replace magnet ring</li> </ul>
The motor does not respond when the e-bike is powered on	<ul style="list-style-type: none"> <li>① Loose wiring</li> <li>② Loose or damaged twist power assistance</li> <li>③ Loose or damaged motor plug wire</li> <li>④ Damaged motor</li> </ul>	<ul style="list-style-type: none"> <li>① Repair and/or reconnect</li> <li>② Tighten or replace</li> <li>③ Secure or replace</li> <li>④ Repair or replace</li> </ul>
Reduced range	<ul style="list-style-type: none"> <li>① Low tire pressure</li> <li>② Low or faulty battery</li> <li>③ Riding up steep hills, into the headwind, and/or with a heavy payload</li> <li>④ Battery discharged for a long period of time without regular charges, aged, damaged, or unbalanced</li> <li>⑤ Brakes rubbing</li> </ul>	<ul style="list-style-type: none"> <li>① Adjust tire pressure</li> <li>② Check connections or charge battery</li> <li>③ Assistance with pedals or adjust the route</li> <li>④ Balance the battery; contact Technical Support if range decline persists</li> <li>⑤ Adjust the brakes</li> </ul>
The battery cannot be charged	<ul style="list-style-type: none"> <li>① Charger not fully connected</li> <li>② Charger damaged</li> <li>③ Battery damaged</li> <li>④ Wiring damaged</li> <li>⑤ Blown charge fuse</li> </ul>	<ul style="list-style-type: none"> <li>① Adjust the connections</li> <li>② Replace</li> <li>③ Replace</li> <li>④ Repair or replace</li> <li>⑤ Replace charge fuse</li> </ul>
Wheel or motor makes strange noises	<ul style="list-style-type: none"> <li>① Loose or damaged wheel spokes or rim</li> <li>② Loose or damaged motor wiring</li> </ul>	<ul style="list-style-type: none"> <li>① Tighten, repair, or replace</li> <li>② Reconnect or replace the motor</li> </ul>

### Error Code Detection

Your e-bike is equipped with an error detection system integrated into the display and controller. It displays the corresponding error code when an electric system fault appears. The following error codes are the most common errors and can aid in troubleshooting. If your bike displays an error code at any time, it is recommended that you cease operation and contact Favoto immediately.

Error Code	Definition
21	Current Abnormal
22	Throttle Abnormal
23	Motor Abnormal
24	Motor Hall Signal Abnormal
25	Brake Abnormal
30	Communication Abnormal