

Lilitab Counter Pro Fixed Mount

Assembly Instructions

v1.0

TABLE OF CONTENTS

Packing List.....	2
Assembly Instructions.....	3
Kensington Lock.....	4
Bolt Down Installation.....	5

FOR BASE PLATE INSTALLATION, YOU'LL NEED:

- ✓ Phillips screwdriver

FOR BOLT DOWN INSTALLATION, YOU'LL NEED:

- ✓ Powered drill/driver, preferably with impact action
- ✓ 4 x bolts or wood screws (m5, no.10, no.11, 3/16" or 13/64 diameter)

TO SECURE YOUR LILITAB YOU WILL NEED:

- ✓ Kensington compatible cable lock
- ✓ Kensington Desk Mount Anchor
- ✓ Loradar Anchor Plate



← Scan to watch
assembly video on
our YouTube Channel!

PACKING LIST

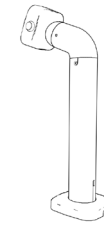

1 x Counter Pro Fixed Mount

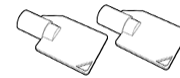

2 x MagDOCK Keys

INCLUDED IF YOU ORDERED COMPACT BASE



1 x Compact Base



4 x Compact Base Screws

GOT QUESTIONS? WE'RE HERE TO HELP!

EMAIL support@lilitab.com **PHONE** 888.705.0190

ASSEMBLY INSTRUCTIONS

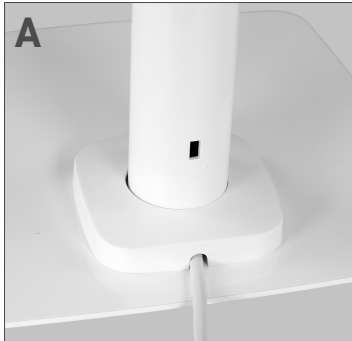

1. Cable routing. Choose your method of how you thread your charge cable that came with your kiosk:

A: Exit out the back of the foot cover (either with base, or securely mounted to substrate—see page 5).

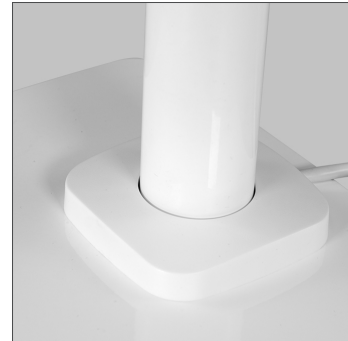

3. Foot Cover. Slide the foot cover down the pole to cover the screws. Velcro will hold it in place once positioned.

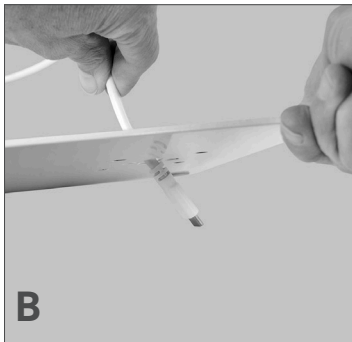

B: Exit through the compact base or substrate (no wire showing). This will require cable routing through your substrate—see page 5.



4. Place your Head Unit onto the MagDOCK mount in either landscape or portrait orientation. **Turn the key** to lock it in place.

WARNING: Not locking the MagDOCK will result in the unit falling off, possibly damaging the unit and/or the tablet. The Lilitab Pro is designed to be operated with the lock closed.

Refer to your Lilitab Head Unit owner's manual for tablet installation instructions.



2. Attach Compact Base. Line up the bottom of the mount pole with the four (4) screw holes in the compact base. Attach using the **four (4) Compact Base Screws.**

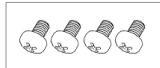

NOTE: You will need to hold the foot cover up and out of your way while bolting. If not using the compact base, attach to surface using template on page 5, and thread the cable through your substrate.

KENSINGTON LOCK



You can use a Kensington Desk Mount Anchor and the Loradar Anchor Plate with a Kensington Lockhead to secure your kiosk on a counter.

PURCHASE OPTIONS FROM AMAZON

Kensington Slim Lockhead:

<https://amzn.to/3lWAAod>

Kensington Desk Mount Anchor:

<https://amzn.to/3njssNU>

Loradar Anchor Plate:

<https://amzn.to/3Ga1wcc>

BOLT DOWN INSTALLATION

The Lilitab Counter Pro Fixed can be permanently mounted to any hard surface.



Power supply cable can run under or on top of surface. In this example, the cables exit through the substrate.

BOLT DOWN INSTRUCTIONS

Use two (2) bolts, wood screws or other fastener suitable for your surface's substrate (m6, no.14 or 1/4" diameter). Use the mounting pattern to the right for proper alignment.

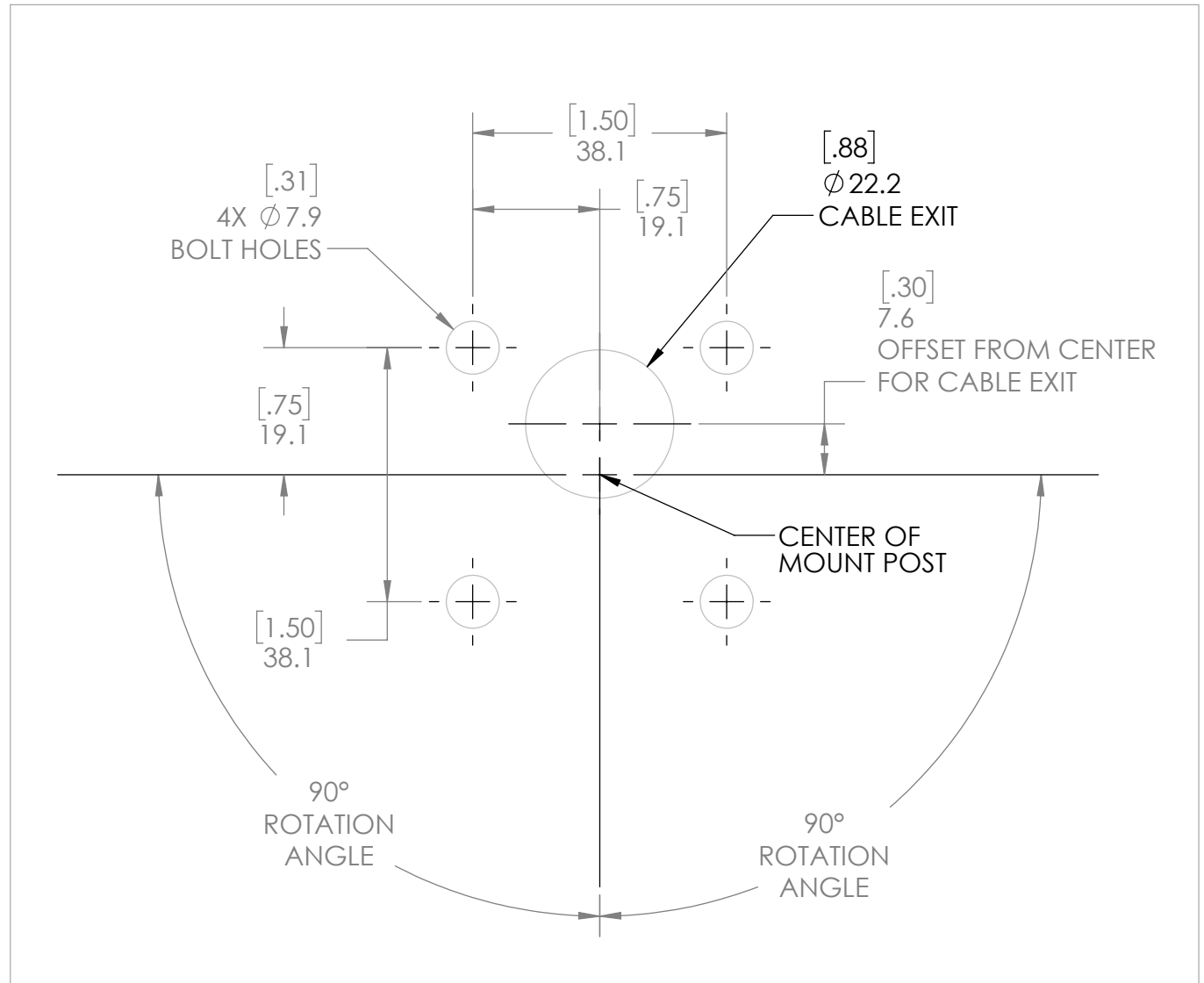

Mounting pattern 1:1 scale