

**HIDEAWAY INCORPORATED**  
 Edmonton, Alberta

**RE: EVALUATION OF HIDEAWAY SCREEN PRODUCTS BY QAI TO THE 2012 ONTARIO BUILDING CODE (2012 OBC) INCLUDING 2022 AMENDMENTS REQUIREMENTS**

QAI Laboratories Ltd. (QAI) has evaluated Hideaway Inc. Privacy Screen products listed below to the requirements of the 2012 OBC including 2022 Amendments:

Table 1: Hideaway Screen Assemblies Evaluated by QAI

1. Branch	2. River Rock	3. Dash	4. Maui	5. Breeze
6. Moderna	7. Hexx	8. Horizon	9. Solid	

Results of the evaluation by QAI to the requirements of the 2012 OBC including 2022 Amendments are outlined in QAI report T1353-8bR1 dated August 22, 2022 and QAI report T1353-8cR1 dated August 22, 2022 and re-issued June 19, 2024.

The conclusions of the above noted QAI reports are summarized below:

Hideaway Inc. **Branch, River Rock, Dash, Maui, Breeze, Moderna, Hexx, Horizon and Solid** privacy screen systems were found to comply with *Loads on Guards and Handrails* requirements of Section 4.1.5.14 of the 2012 OBC (including 2022 Amendments).

Hideaway Inc. **Branch, River Rock, Dash, Maui, Breeze, Moderna, Hexx, Horizon and Solid** privacy screen systems when installed with panels having clearance between bottom of panel and substrate at < 100 mm, comply with *Guards* Sections 3.3.1.17 and 9.8.8.5 *Openings in Guards* requirements of the 2012 OBC (including 2022 Amendments).

Hideaway Inc. **Branch, River Rock, Breeze, Maui and Moderna** privacy screen assemblies were found to have openings that do not restrict climbability and do not comply with *Design of Guards to Not Facilitate Climbing* Section 9.8.8.6 requirements of the 2012 OBC (including 2022 Amendments). These products shall not be installed in buildings or areas of residential occupancy where guards are required.

For additional details of QAI's evaluations, please see QAI report T1353-8bR1 dated August 22, 2022 and QAI report T1353-8cR1 dated August 22, 2022.

**Disclaimer:** This report outlines evaluation of the above-described systems for compliance to the service and factored loads and material specifications as outlined by the above building codes. This report does not constitute site design. Details including but not limited to wind load resistance, anchorage connections and other areas as required by the specific site per the applicable code are to be specified by the engineer of record and authority having jurisdiction.

**Prepared By:**



James R. Scott, P. Eng.  
 Project Manager

**Signed for and on behalf of  
 QAI Laboratories Ltd.**



Matt Lansdowne  
 VP of Operations

**\*\*This report supersedes prior reports issued for Hideaway Inc. Privacy Screens per project T1353-8.**

**Attachments:** Hideaway Screen Product Drawings

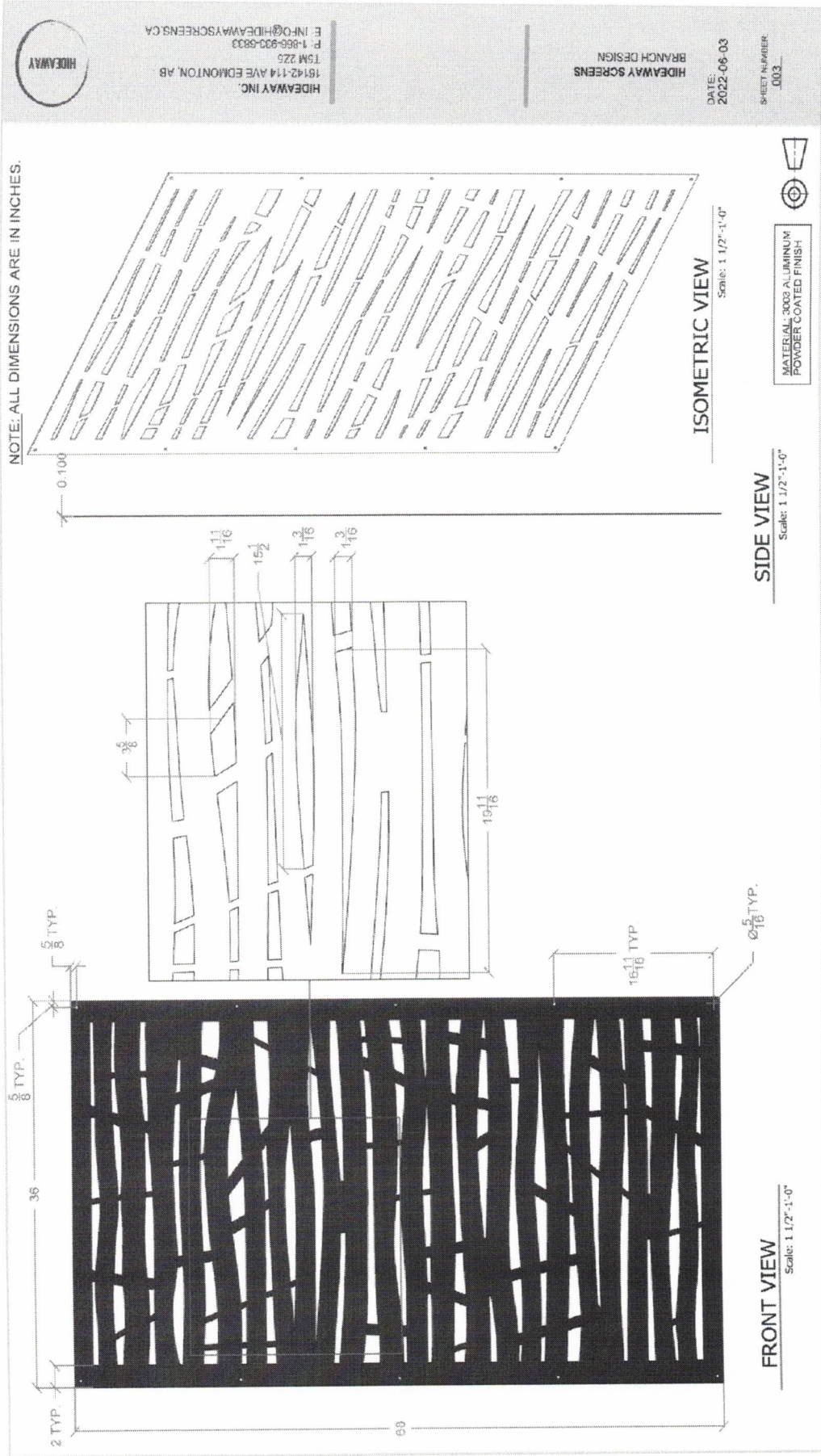

THIS REPORT IS THE CONFIDENTIAL PROPERTY OF THE CLIENT ADDRESSED. THE REPORT MAY ONLY BE REPRODUCED IN FULL. PUBLICATION OF EXTRACTS FROM THIS REPORT IS NOT PERMITTED WITHOUT WRITTEN APPROVAL FROM QAI. ANY LIABILITY ATTACHED THERETO IS LIMITED TO THE FEE CHARGED FOR THE INDIVIDUAL PROJECT FILE REFERENCED. THE RESULTS OF THIS REPORT PERTAIN ONLY TO THE SPECIFIC SAMPLE(S) EVALUATED.

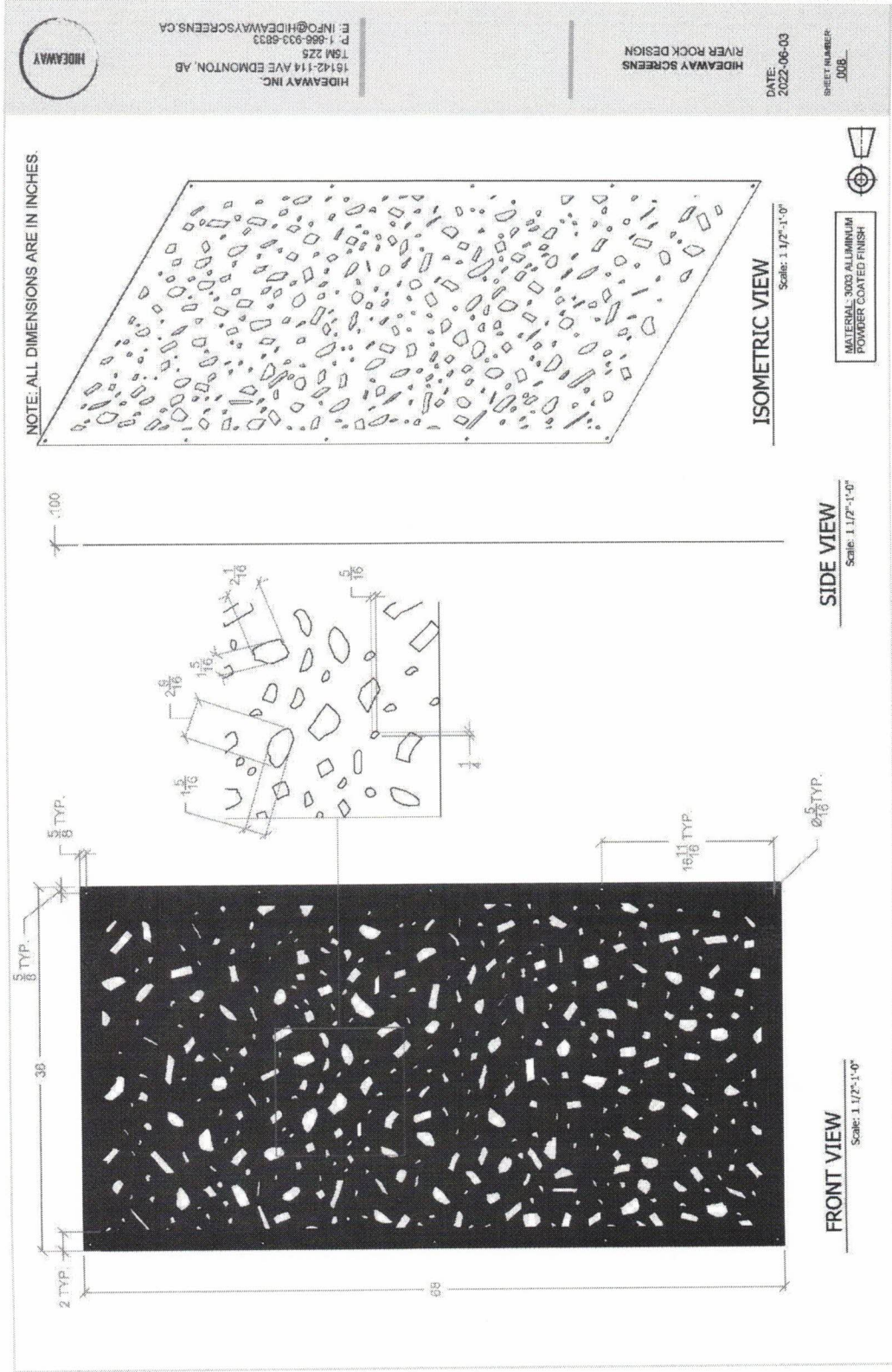

THIS REPORT IS THE CONFIDENTIAL PROPERTY OF THE CLIENT ADDRESSED. THE REPORT MAY ONLY BE REPRODUCED IN FULL. PUBLICATION OF EXTRACTS FROM THIS REPORT IS NOT PERMITTED WITHOUT WRITTEN APPROVAL FROM QAI. ANY LIABILITY ATTACHED THERETO IS LIMITED TO THE FEE CHARGED FOR THE INDIVIDUAL PROJECT FILE REFERENCED. THE RESULTS OF THIS REPORT PERTAIN ONLY TO THE SPECIFIC SAMPLE(S) EVALUATED.

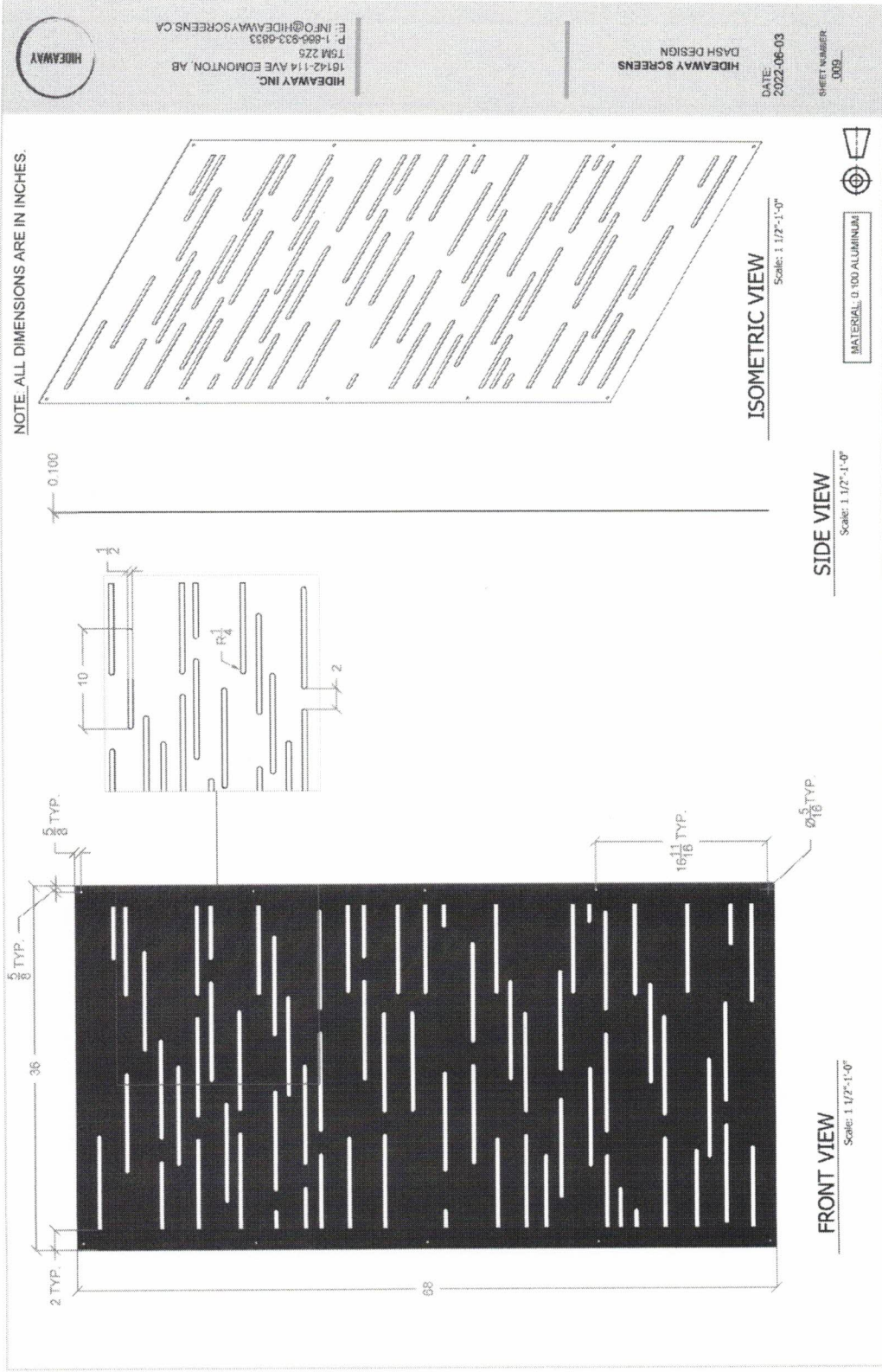

THIS REPORT IS THE CONFIDENTIAL PROPERTY OF THE CLIENT. ADDRESSING, THE REPORT MAY ONLY BE REPRODUCED IN FULL. PUBLICATION OF EXTRACTS FROM THIS REPORT IS NOT PERMITTED WITHOUT WRITTEN APPROVAL FROM QAI. ANY LIABILITY ATTACHED THERETO IS LIMITED TO THE INDIVIDUAL PROJECT FILE REFERENCED. THE RESULTS OF THIS REPORT PERTAIN ONLY TO THE SPECIFIC SAMPLE(S) EVALUATED.

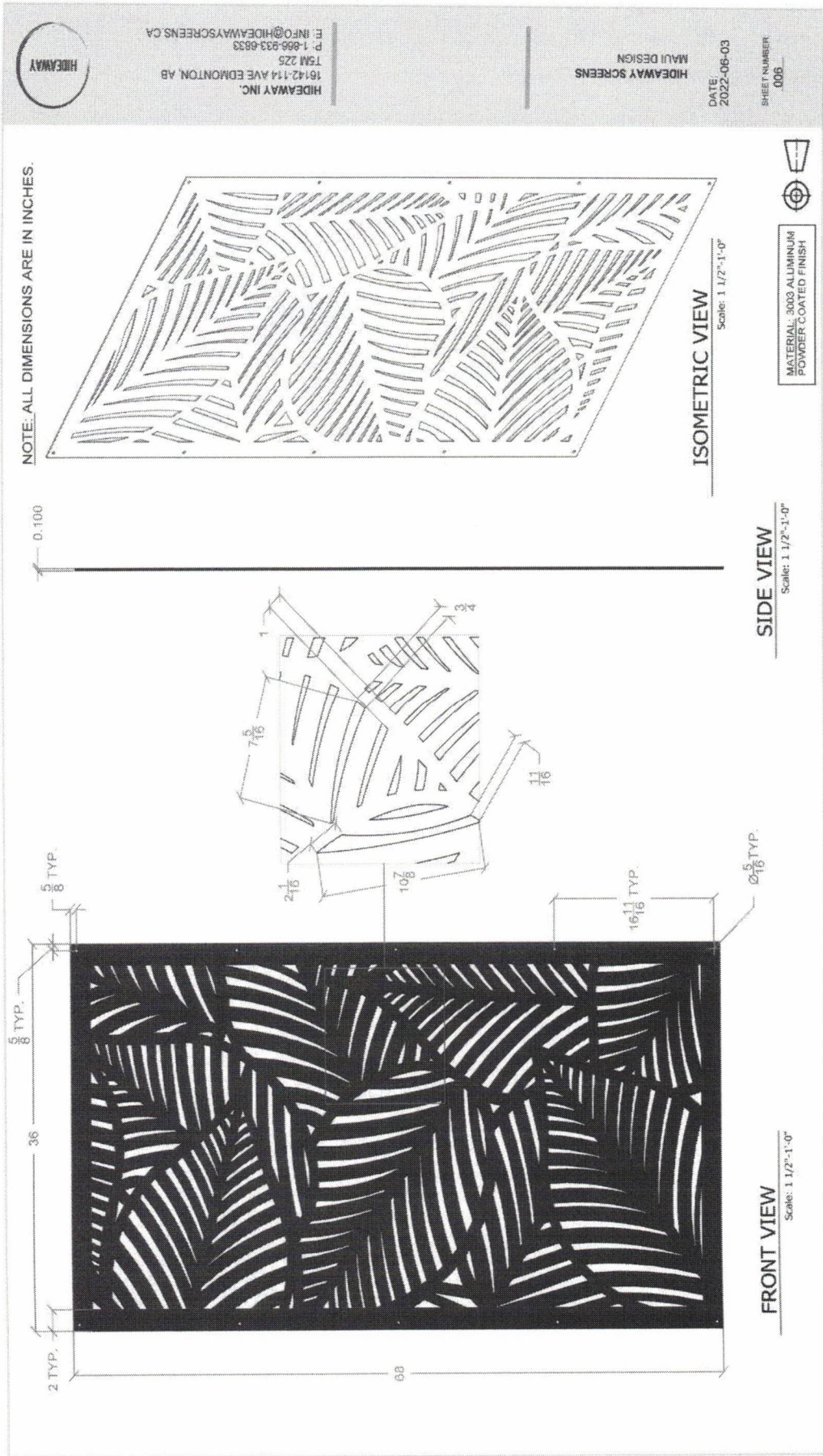

THIS REPORT IS THE CONFIDENTIAL PROPERTY OF THE CLIENT ADDRESSED. THE REPORT MAY ONLY BE REPRODUCED IN FULL. PUBLICATION OF EXTRACTS FROM THIS REPORT IS NOT PERMITTED WITHOUT WRITTEN APPROVAL FROM QAI. ANY LIABILITY ATTACHED THERETO IS LIMITED TO THE FEE CHARGED FOR THE INDIVIDUAL PROJECT FILE REFERENCED. THE RESULTS OF THIS REPORT PERTAIN ONLY TO THE SPECIFIC SAMPLE(S) EVALUATED.

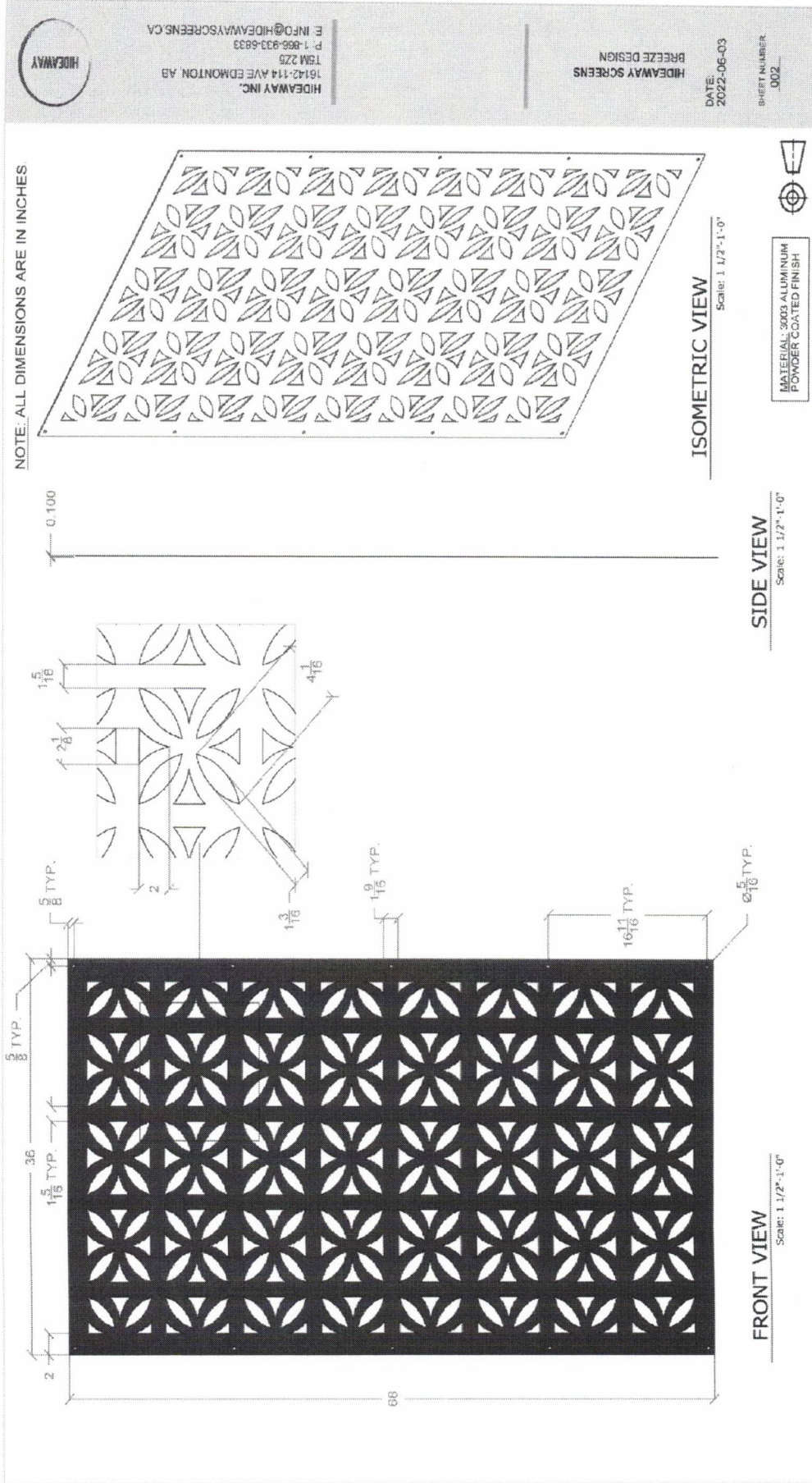

THIS REPORT IS THE CONFIDENTIAL PROPERTY OF THE CLIENT ADDRESSED. THE REPORT MAY ONLY BE REPRODUCED IN FULL. PUBLICATION OF EXTRACTS FROM THIS REPORT IS NOT PERMITTED WITHOUT WRITTEN APPROVAL FROM QAI. ANY LIABILITY ATTACHED THERETO IS LIMITED TO THE FEE CHARGED FOR THE INDIVIDUAL PROJECT FILE REFERENCED. THE RESULTS OF THIS REPORT PERTAIN ONLY TO THE SPECIFIC SAMPLE(S) EVALUATED.

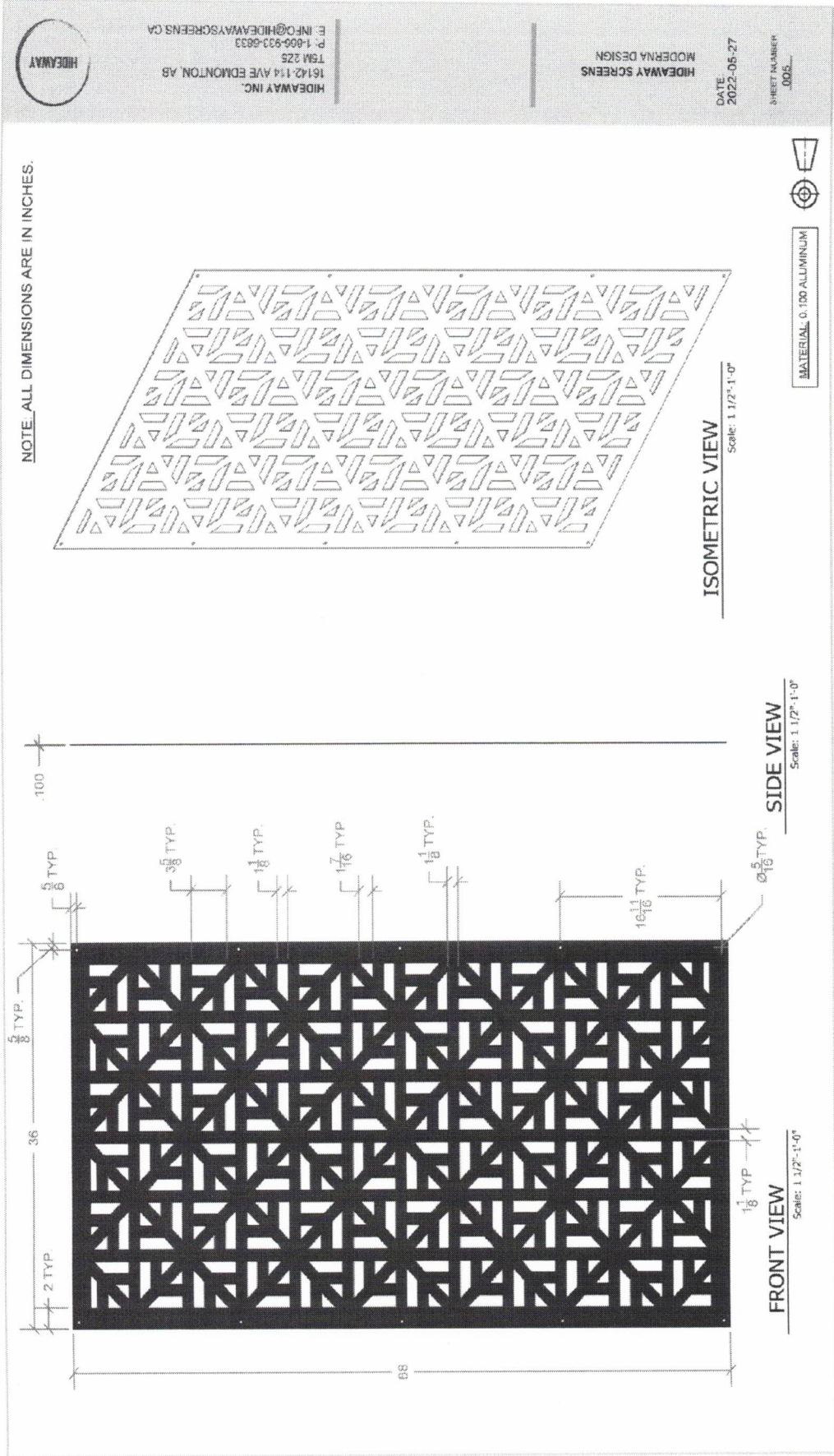

THIS REPORT IS THE CONFIDENTIAL PROPERTY OF THE CLIENT ADDRESSED. THE REPORT MAY ONLY BE REPRODUCED IN FULL. PUBLICATION OF EXTRACTS FROM THIS REPORT IS NOT PERMITTED WITHOUT WRITTEN APPROVAL FROM QAI. ANY LIABILITY ATTACHED THERETO IS LIMITED TO THE FEE CHARGED FOR THE INDIVIDUAL PROJECT FILE REFERENCED. THE RESULTS OF THIS REPORT PERTAIN ONLY TO THE SPECIFIC SAMPLE(S) EVALUATED.

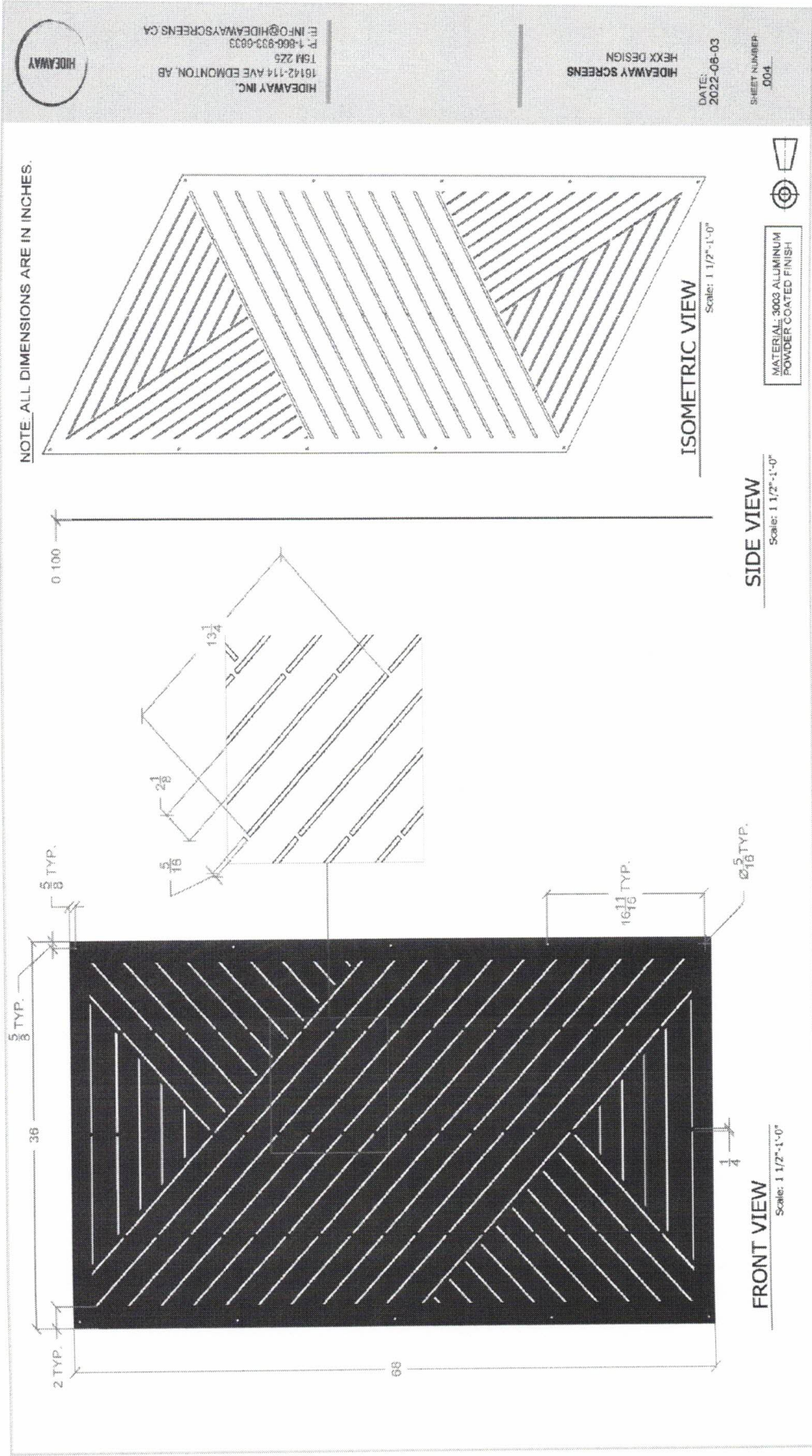

THIS REPORT IS THE CONFIDENTIAL PROPERTY OF THE CLIENT ADDRESSED. THE REPORT MAY ONLY BE REPRODUCED IN FULL. PUBLICATION OF EXTRACTS FROM THIS REPORT IS NOT PERMITTED WITHOUT WRITTEN APPROVAL FROM QAI. ANY LIABILITY ATTACHED THERETO IS LIMITED TO THE FEE CHARGED FOR THE INDIVIDUAL PROJECT FILE REFERENCED. THE RESULTS OF THIS REPORT PERTAIN ONLY TO THE SPECIFIC SAMPLE(S) EVALUATED.



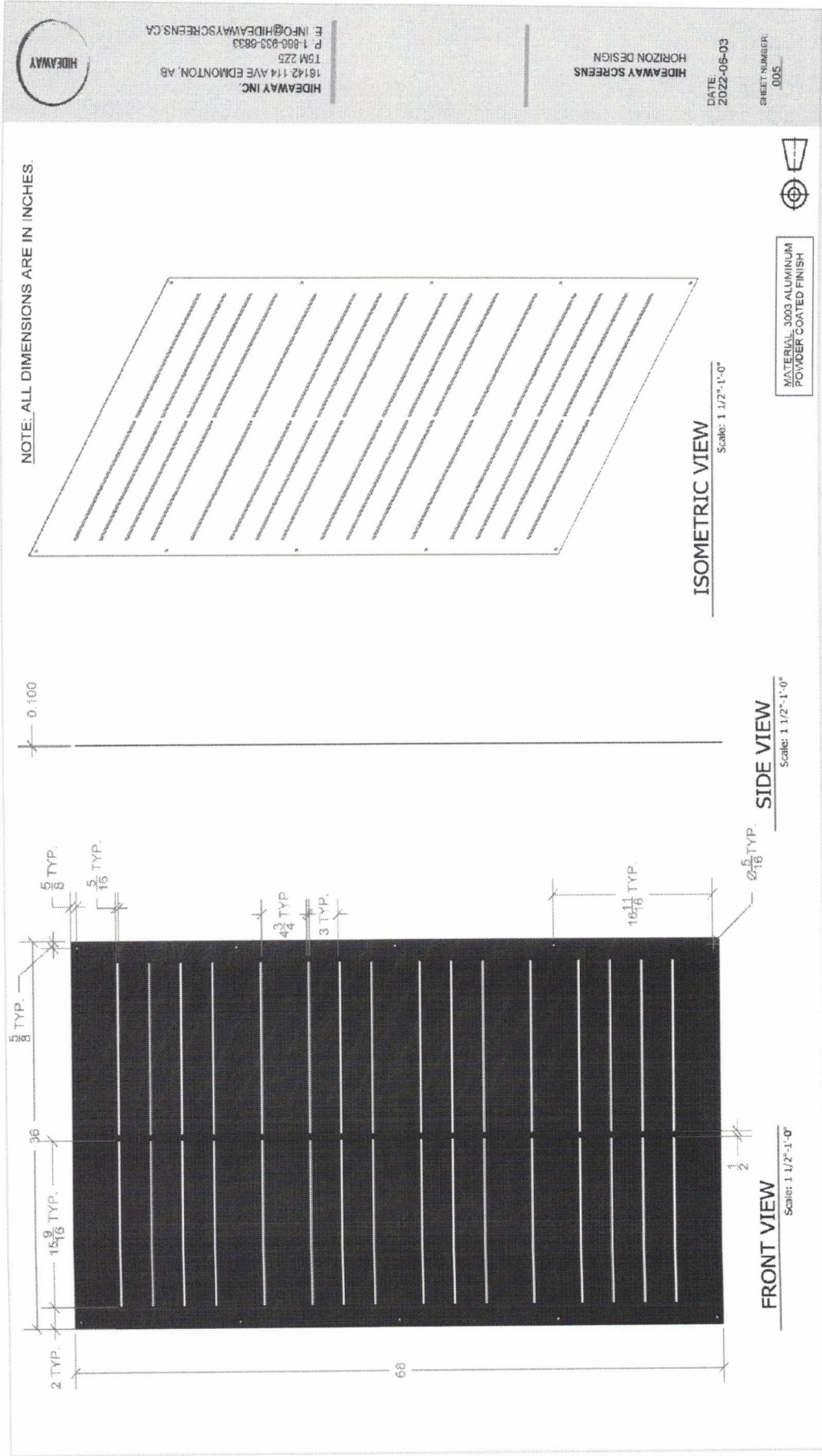

THIS REPORT IS THE CONFIDENTIAL PROPERTY OF THE CLIENT ADDRESSED. THE REPORT MAY ONLY BE REPRODUCED IN FULL. PUBLICATION OF EXTRACTS FROM THIS REPORT IS NOT PERMITTED WITHOUT WRITTEN APPROVAL FROM QAI. ANY LIABILITY ATTACHED THERETO IS LIMITED TO THE FEE CHARGED FOR THE INDIVIDUAL PROJECT FILE REFERENCED. THE RESULTS OF THIS REPORT PERTAIN ONLY TO THE SPECIFIC SAMPLE(S) EVALUATED.

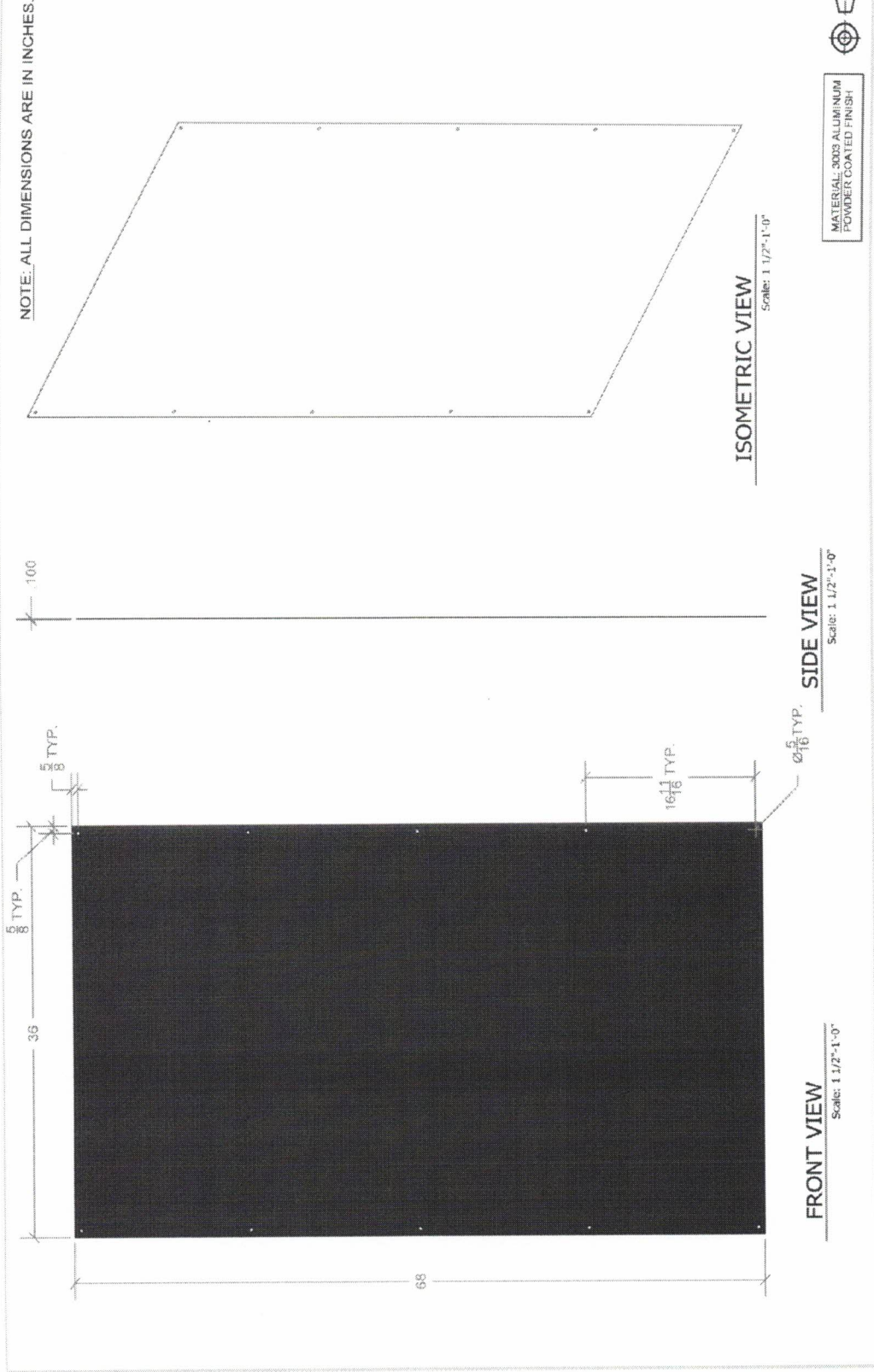

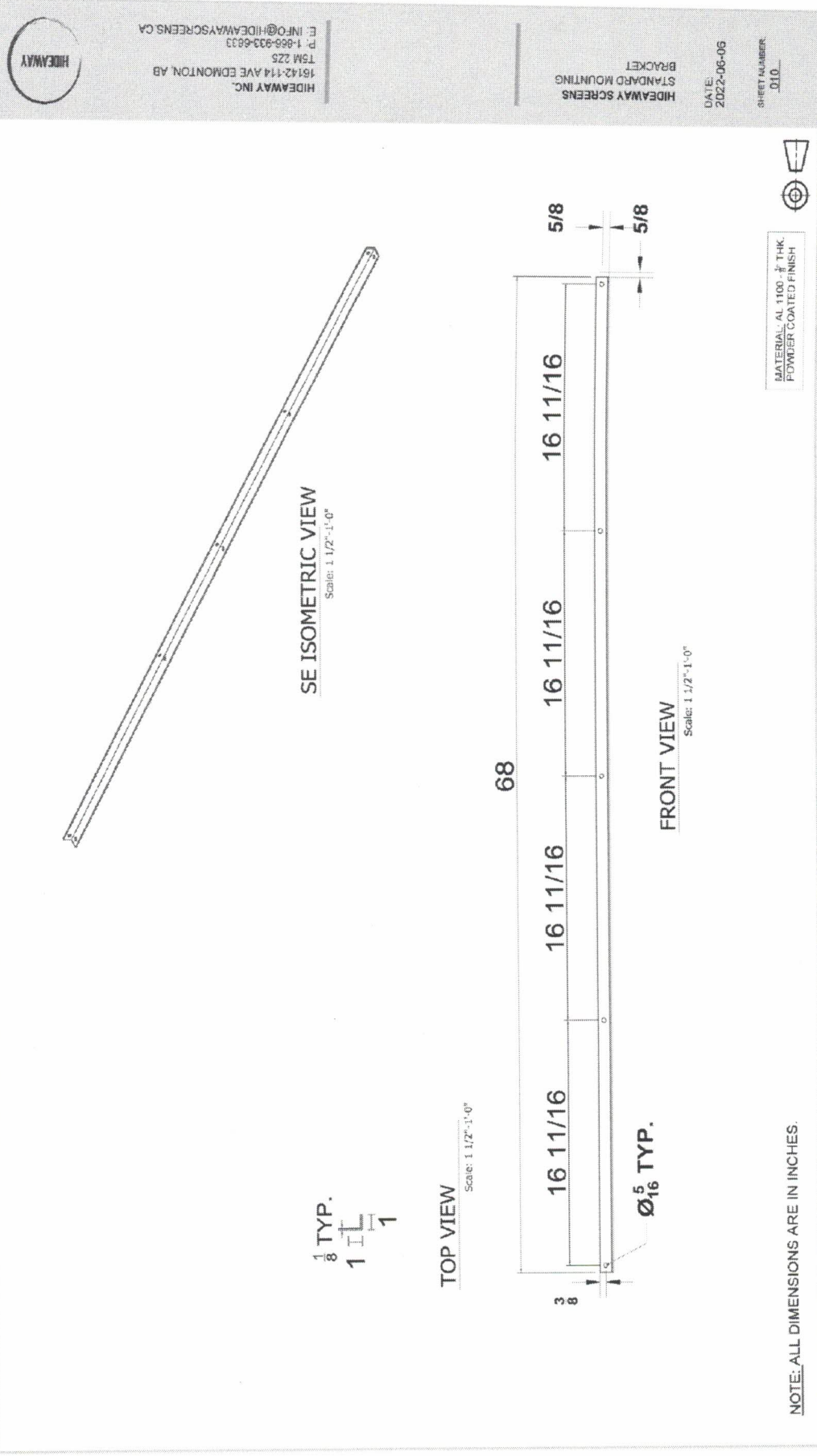

THIS REPORT IS THE CONFIDENTIAL PROPERTY OF THE CLIENT ADDRESSED. THE REPORT MAY ONLY BE REPRODUCED IN FULL. PUBLICATION OF EXTRACTS FROM THIS REPORT IS NOT PERMITTED WITHOUT WRITTEN APPROVAL FROM QAI. ANY LIABILITY ATTACHED THERETO IS LIMITED TO THE FEE CHARGED FOR THE INDIVIDUAL PROJECT FILE REFERENCED. THE RESULTS OF THIS REPORT PERTAIN ONLY TO THE SPECIFIC SAMPLE(S) EVALUATED.

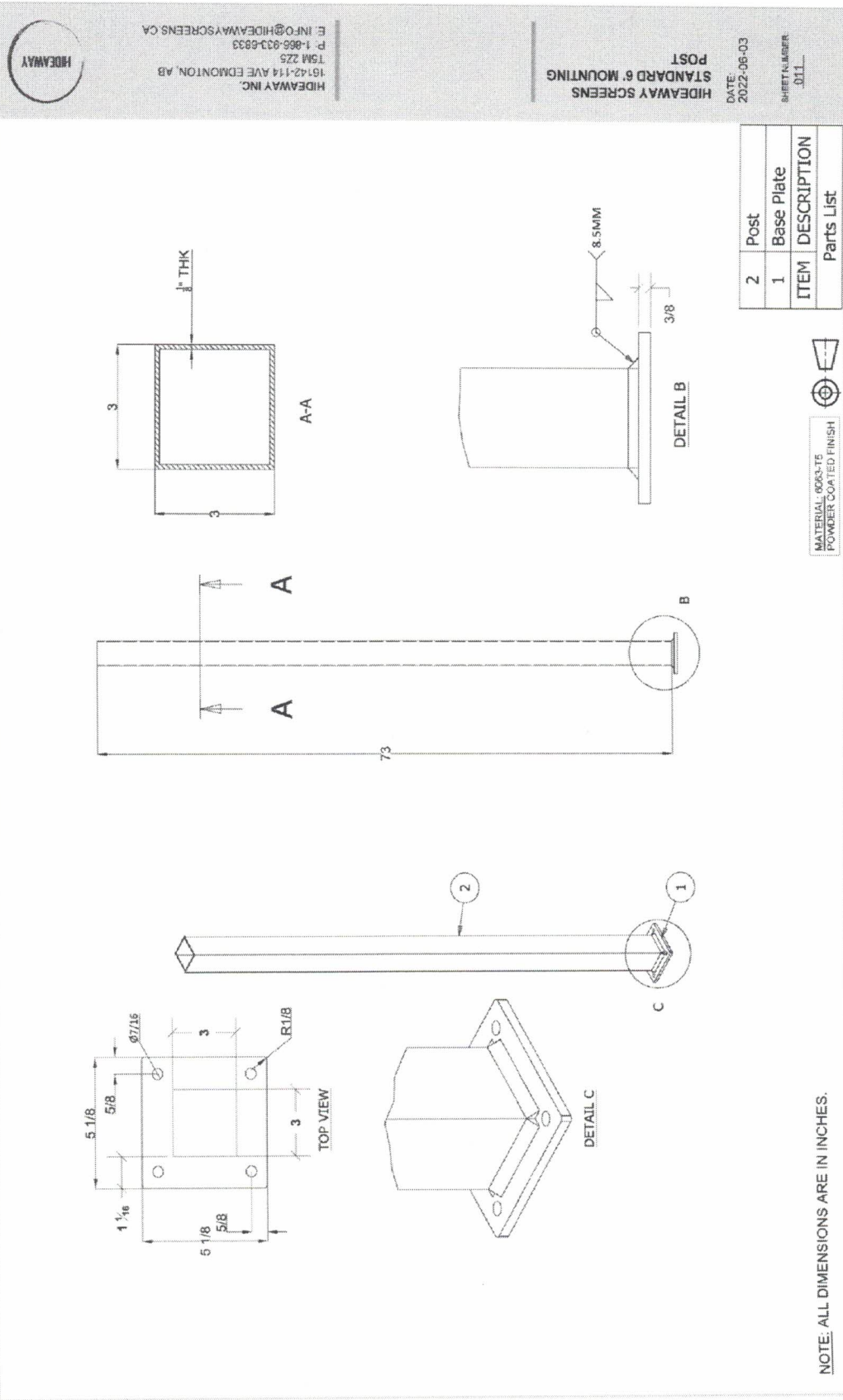

HIDEAWAY INC.  
 131M 225  
 16142-114 AVE EDMONTON, AB  
 P: 1-866-933-8933  
 E: INFO@HIDEAWAYSCREENS.CA

HIDEAWAY SCREENS  
 STANDARD 6 MOUNTING  
 POST

DATE: 2022-06-03  
 SHEET NUMBER: .011

MATERIAL: 6063-T5  
 POWDER COATED FINISH



ITEM	DESCRIPTION	Parts List
2	Post	
1	Base Plate	

NOTE: ALL DIMENSIONS ARE IN INCHES.

THIS REPORT IS THE CONFIDENTIAL PROPERTY OF THE CLIENT ADDRESSED. THE REPORT MAY ONLY BE REPRODUCED IN FULL. PUBLICATION OF EXTRACTS FROM THIS REPORT IS NOT PERMITTED WITHOUT WRITTEN APPROVAL FROM QAI. ANY LIABILITY ATTACHED THERETO IS LIMITED TO THE FEE CHARGED FOR THE INDIVIDUAL PROJECT FILE REFERENCED. THE RESULTS OF THIS REPORT PERTAIN ONLY TO THE SPECIFIC SAMPLE(S) EVALUATED.



**EXPLODED VIEW**  
Scale: 1"-1'-0"

**ISOMETRIC VIEW**  
Scale: 1/2"=1'-0"

**4 ACORN NUT**  
Scale: 1:1  
Part: 0.4675

**5 MACHINE SCREW**  
Scale: 1:1  
Part: 0.8805

**7 SELF DRILLING SCREW**  
Scale: 1:1  
Part: 0.4675

ITEM	DESCRIPTION	QTY
9	Post Cap	2
8	Base Skirt	2
7	Self Drilling Screw	10
6	Mounting Bracket	2
5	Machine Screw	10
4	Acorn Nut	10
3	Privacy Screen	1
2	Post	2
1	Base Plate	2

**Parts List**

**HIDEAWAY INC.**  
 16142-114 AVE EDMONTON, AB  
 T5M 2Z5  
 P 1-866-933-6828  
 E INFO@HIDEAWAYSCREENS.CA

**HIDEAWAY SCREENS**  
 STANDARD ASSEMBLY

DATE: 2022-06-05  
 SHEET NUMBER: 011

**REVISION SUMMARY:**

Summary report re-issued and re-sealed by a practicing Professional Engineer. June 19, 2024

THIS REPORT IS THE CONFIDENTIAL PROPERTY OF THE CLIENT ADDRESSED. THE REPORT MAY ONLY BE REPRODUCED IN FULL. PUBLICATION OF EXTRACTS FROM THIS REPORT IS NOT PERMITTED WITHOUT WRITTEN APPROVAL FROM QAI. ANY LIABILITY ATTACHED THERETO IS LIMITED TO THE FEE CHARGED FOR THE INDIVIDUAL PROJECT FILE REFERENCED. THE RESULTS OF THIS REPORT PERTAIN ONLY TO THE SPECIFIC SAMPLE(S) EVALUATED.