

HIDEAWAY

HIDEAWAY PRIVACY SCREENS

Assembly Manual



Scan to play Setup Video

English

HIDEAWAY

INTRODUCTION

Introducing the Hideaway Privacy Screen assembly manual. In this Manual we are showing the installation of the Hideaway Screens with the Hideaway Mounting Posts, and Mounting Brackets into a wood or composite deck surface.



MOUNTING OPTIONS

If you are installing your posts into concrete, or are not using the mounting brackets for the face mount option, please refer to the respective section in the manual for that application.

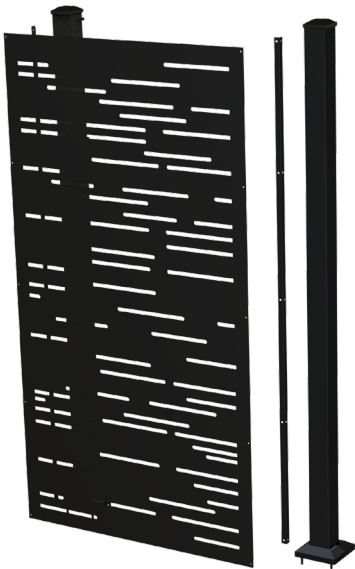

MOUNTING BRACKETS

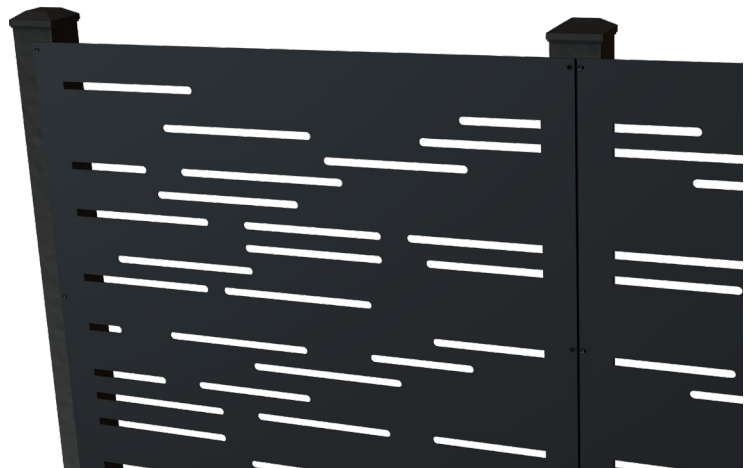

FACE-MOUNT INSTALLATION



WARNING

Some steps might require the assistance of two people.

PARTS & TOOLS CHECK LIST

The following Parts are included with your Assembly. The following tools are recommended for this assembly.

PARTS LIST

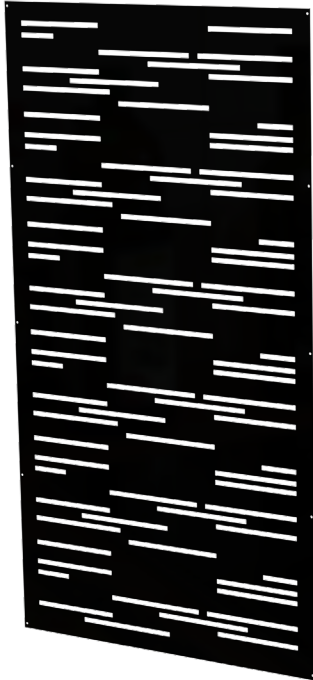

**STANDARD HIDEAWAY
PRIVACY SCREEN**
(36" W x 68" H)



**MOUNTING
POST**
(3" x 3" x 73" H)



**MOUNTING
BRACKET**
(1" x 1" x 68" H)

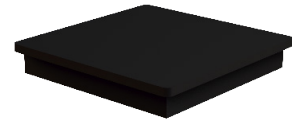

POST CAPS

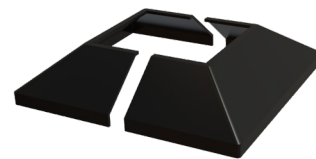

**BASE PLATE
SKIRTS**

OPTIONAL HARDWARE



**(SOLD SEPARATELY)
CONCRETE WEDGE ANCHORS**
(MOUNT PLANTER BASE
INTO CONCRETE) (D)



**(SOLD SEPARATELY)
GRK RSS WOOD SCREWS**
(C)

INCLUDED HARDWARE



MACHINE SCREWS
(QTY: 10)
(A)



SELF DRILLING SCREWS
(QTY: 10)
(B)



ACORN NUTS
(QTY: 10)
(A)

RECOMMENDED TOOLS



HAND LEVEL



POWER DRILL
w/ #3 ROBERTSON BIT



**MEASURING
TAPE**



SCREWDRIVER

INSTRUCTIONS

Step 1 - Post Installation into Wood, and Composite

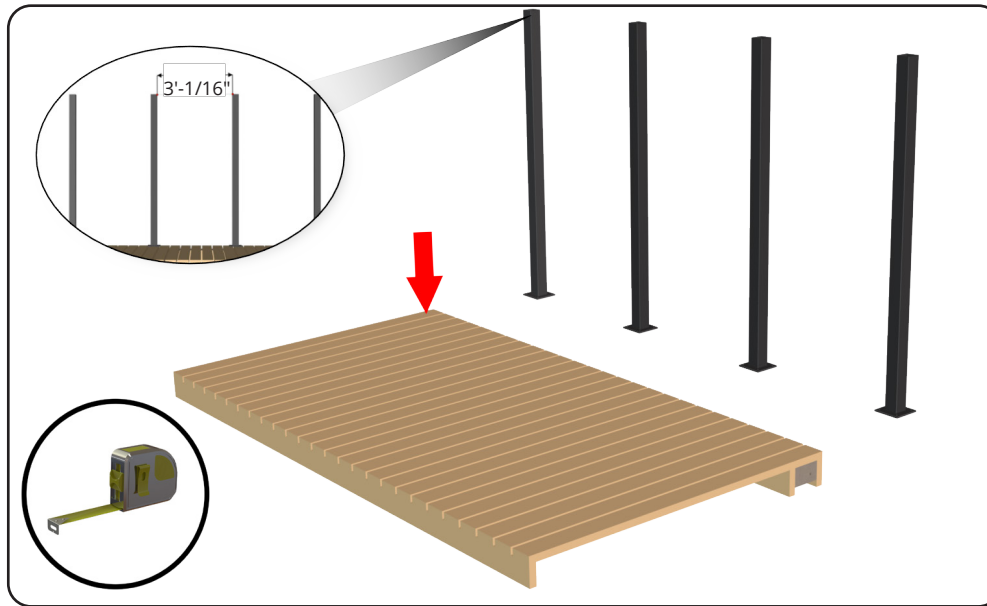

1. Place the Posts

Begin step one by placing the posts in the desired location, and measure the distance between them so that they are 3'-1/16" apart.

Ensure necessary backing is provided for stability, and safety. See the engineering drawings for the recommended backing details.

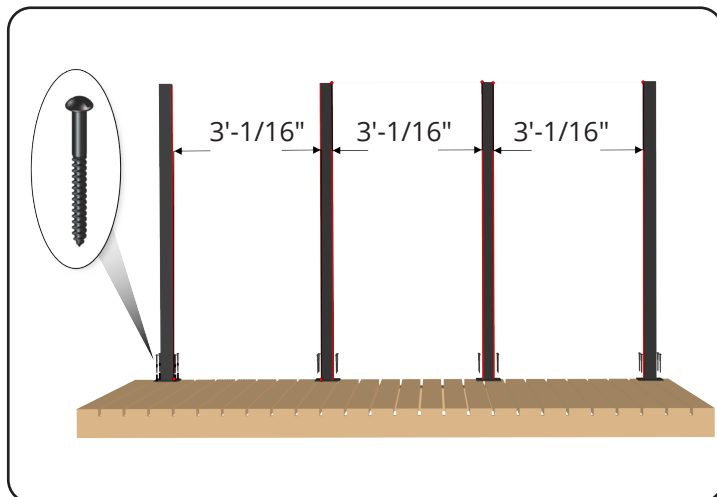

2. Fasten the Posts

After confirming your measurements, fasten the posts through the predrilled holes on the base plate into your deck surface using the GRK Structural Screws.

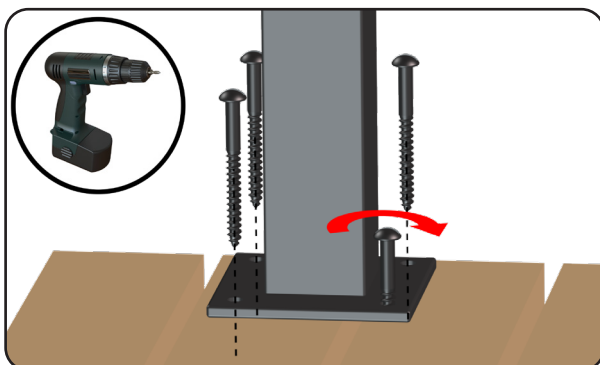

3. Secure the Base

The Lag bolts are sold separately. Choose the appropriate anchoring bolts, based on your application.

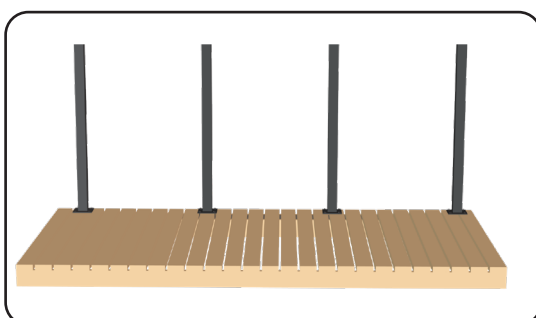

4. Secure the Posts

Double check your installation with a level on both side of the post. Fully fasten, and secure the posts.

After securing all posts, step 1 is now complete.

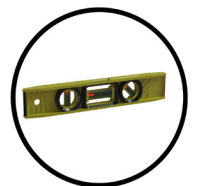

INSTRUCTIONS

Step 2 - Installing the Mounting Brackets

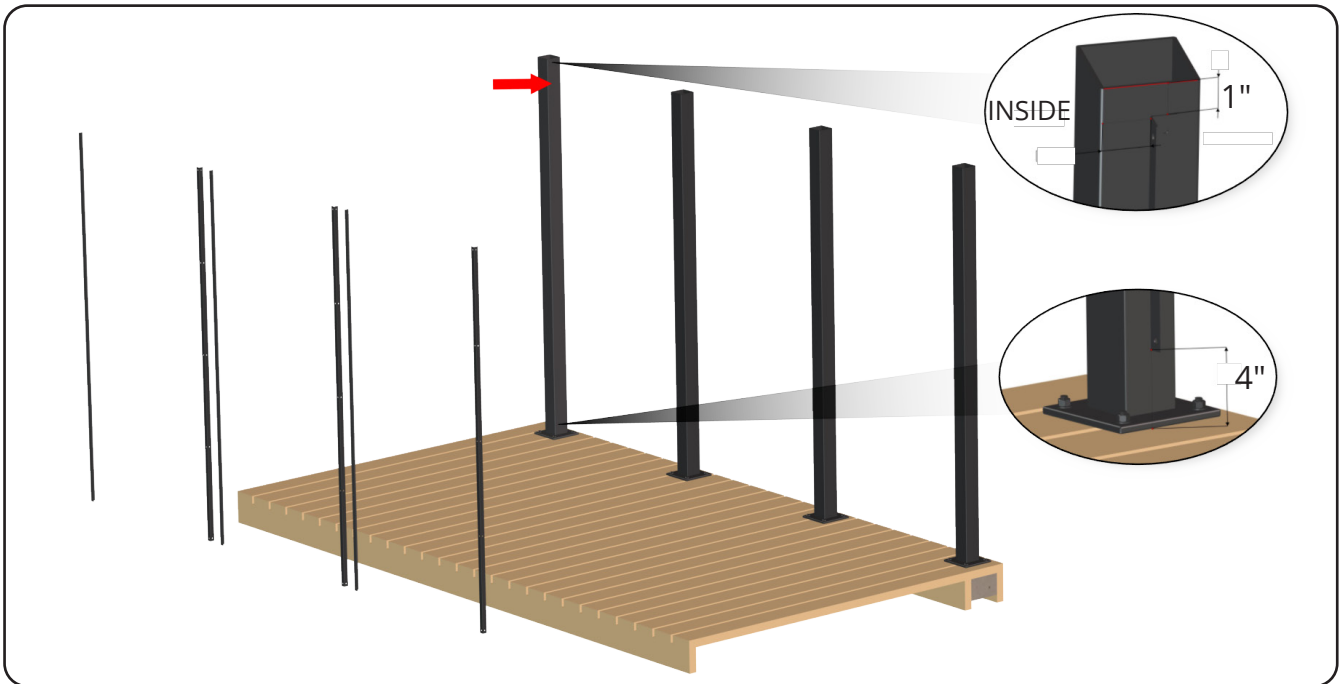

1. Place the Brackets

Begin Step Two by placing the mounting brackets such that the face of the “L”, is on the centerline of the post. Measure the desired height of the screen.

It is recommended that the mounting bracket sits 4 inches from the ground surface, and 1 inch below the top of the post. This is also the recommended spacing under most building code requirements, however please ensure you comply with your local municipalities building codes.

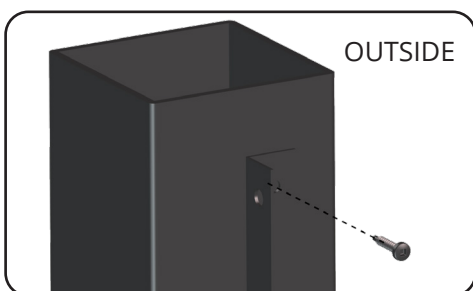

3. Affix the Mounting Brackets

Ensure the Bracket is facing towards the outside, and the flat face is facing towards the inside.

Set the brackets on the inside of the post, right on the center. Affix the mounting bracket to the post using the self-tapping screws.

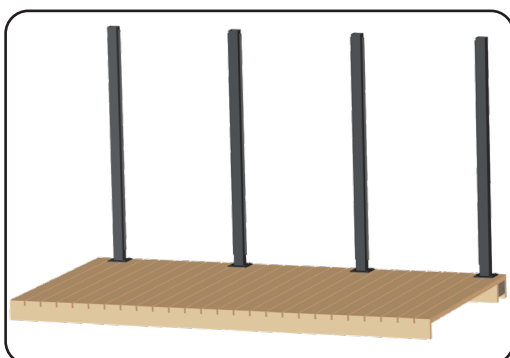

4. Tighten the Screws

Fully tighten all screws.
Repeat these steps, and fully secure all brackets.

Step two is now complete.



Please note: Another option is installing the first post, then mounting the brackets and screen to the post before installing the second post, third, and so forth.

INSTRUCTIONS

Step 3 - Installing the Privacy Screens

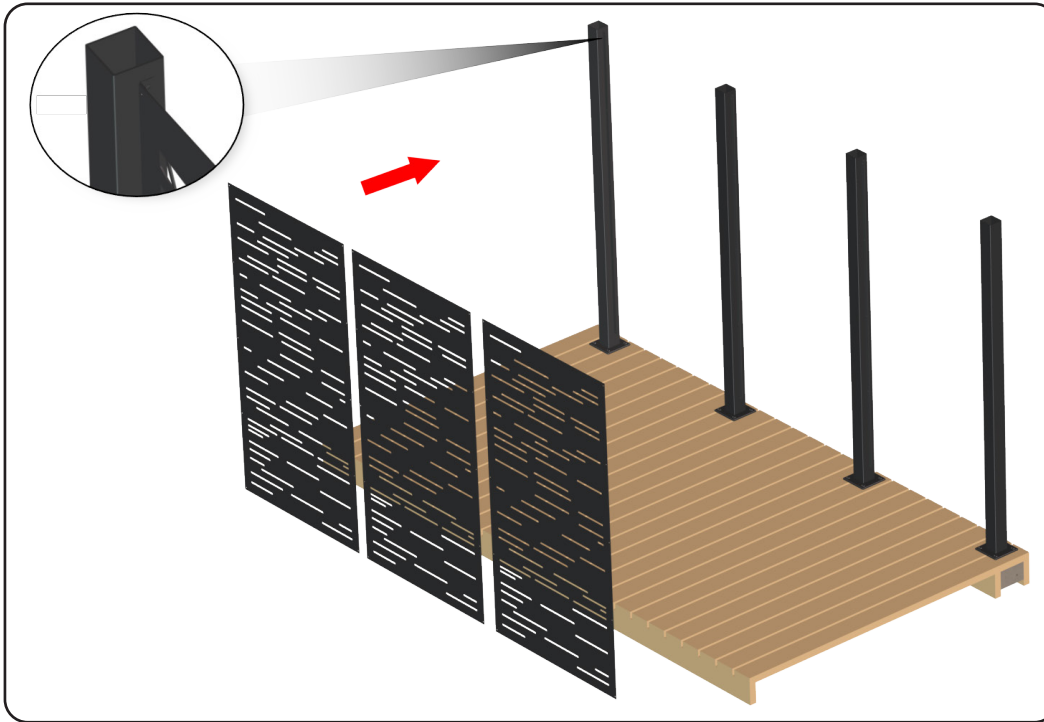

1. Place Privacy Screens on the Mounting Brackets

After securing the mounting brackets, you may install the Privacy Screens.

Please Note: For proper fitment, the bracket is to be completely behind the screen.

With some assistance, place the screen up against the brackets and align with the pre-drilled holes on the bracket.

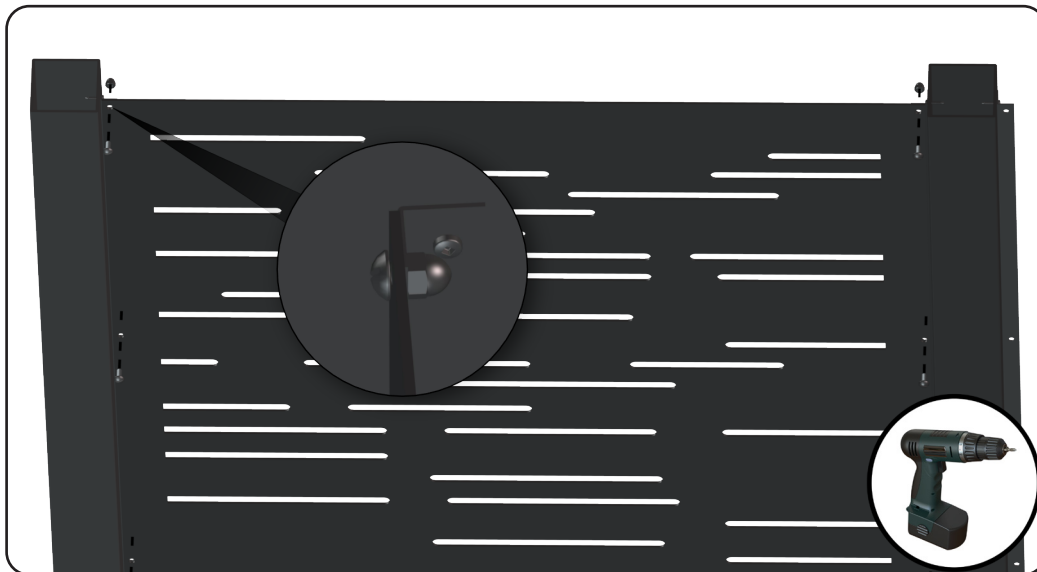

2. Install the Screen

Mount the screen to the face of the installed brackets using the provided machine screws, and acorn nuts.

Fully tighten the screws using a Flathead Screwdriver or drill.

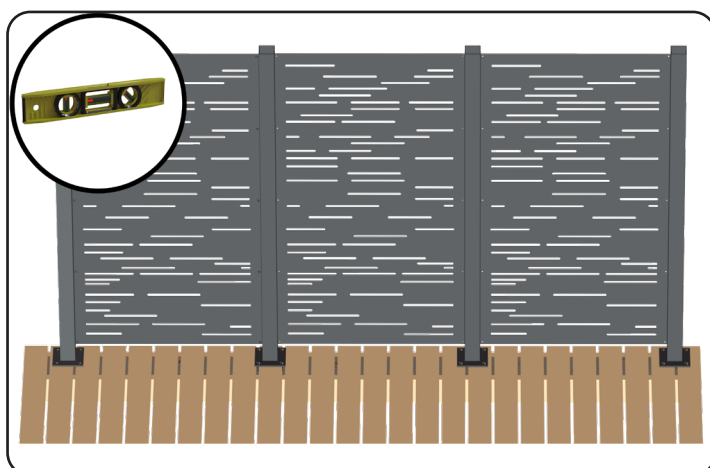

3. Secure all Screens

Secure all screws to fully secure the Privacy Screen on to the mounting brackets.

Repeat these steps, for all remaining screens for your project.

Once all screens have been tightly secured, step 3 is now complete.

INSTRUCTIONS

Step 4 - Post Cap and Base Plate Skirt Installation

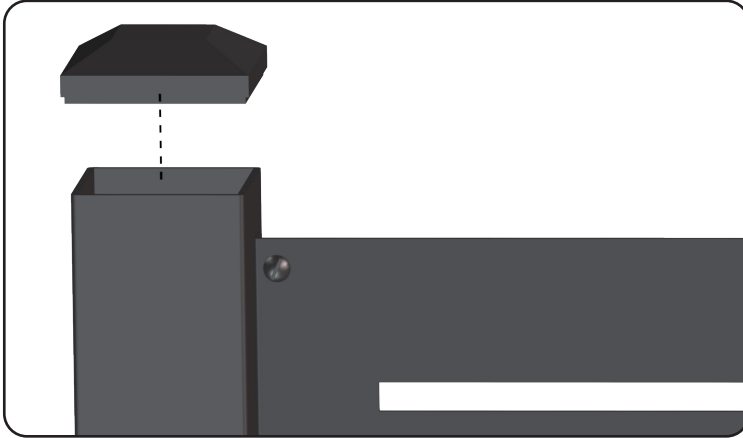
**1. Place the Post Caps**

After all screens have been fully secured, you may install the top Post Caps.

Place the Post Caps on top of each post, and slide it in place.

You may tap the caps by hand for a tighter fit.

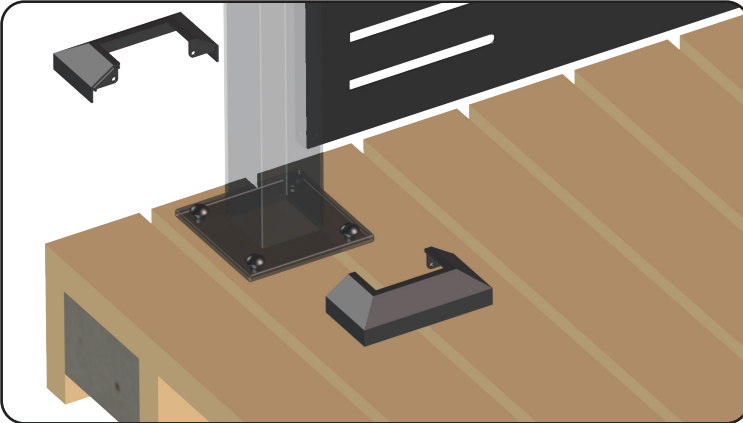
**2. Align the Base Plate Skirts**

Next, locate the bottom of the posts.

Align the Base Plate Skirts on top of the base plates.

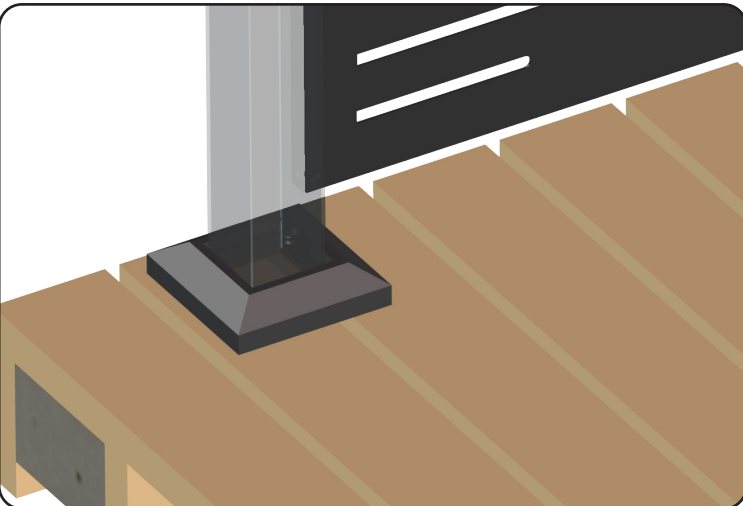
**3. Secure the Skirts**

Fasten the skirt parts together with the included screws, and fully cover the base plates.

Repeat these steps for all remaining posts.

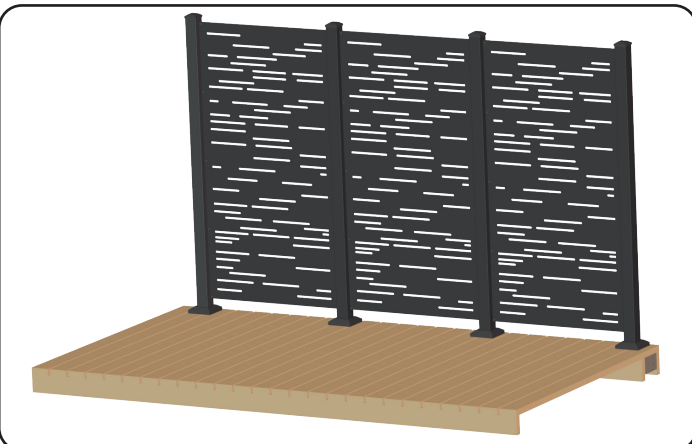
**4. Ensure all part are properly assembled**

Congratulations! Assembly of your Hideaway Privacy Screens, is now complete.

Check to ensure all components are tight, and properly assembled in accordance with the assembly manual.

Enjoy your new, Hideaway Privacy Screens!

OPTION 2

The Face Mounting option, is when you are looking to create a monolithic look, without breaking up the design with posts. This is also a great option when our standard sizing with posts is longer than the space allows.

Face-Mount Installation

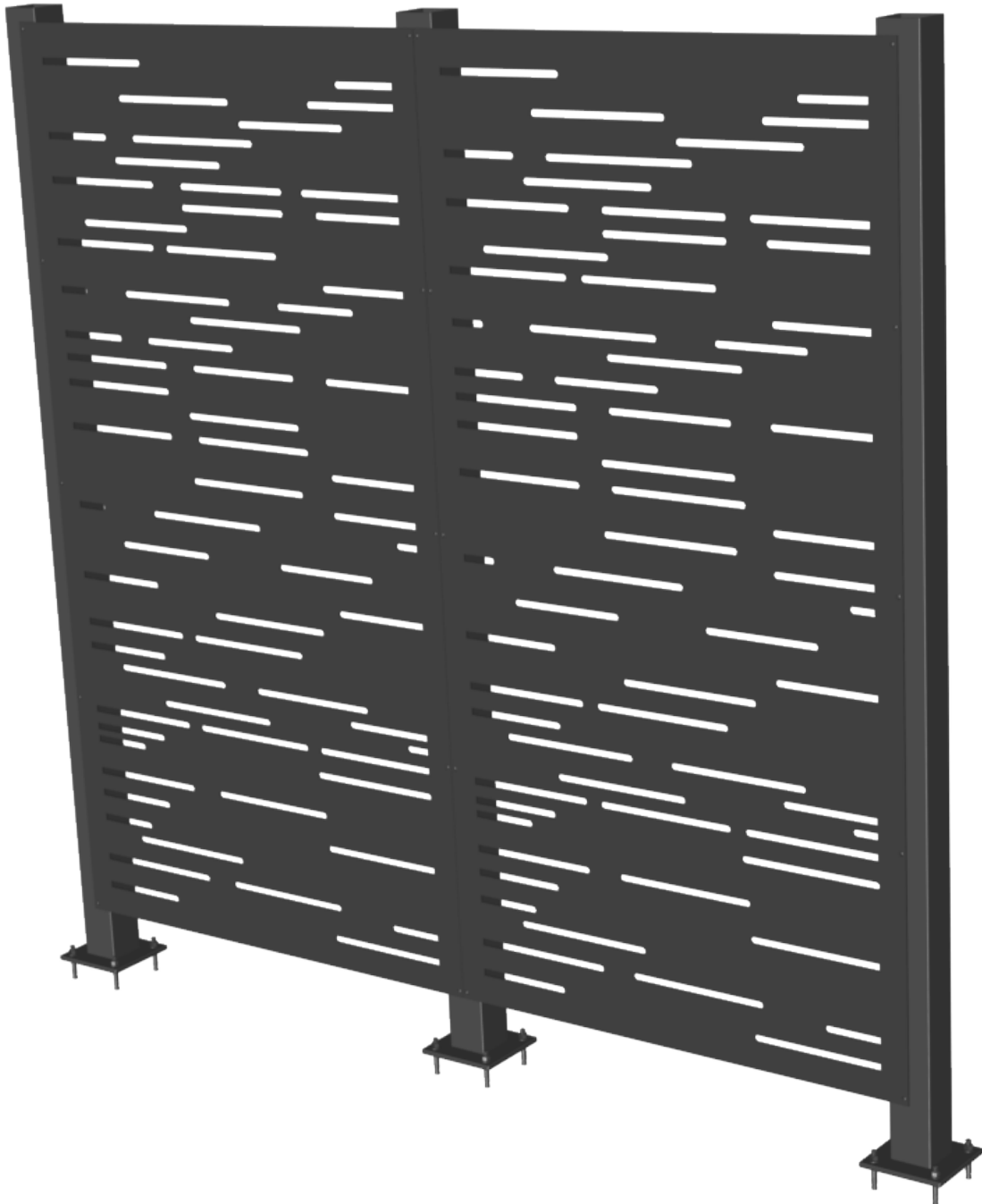

INSTRUCTIONS

Step 1 - Post Installation into Wood and Composite Surfaces

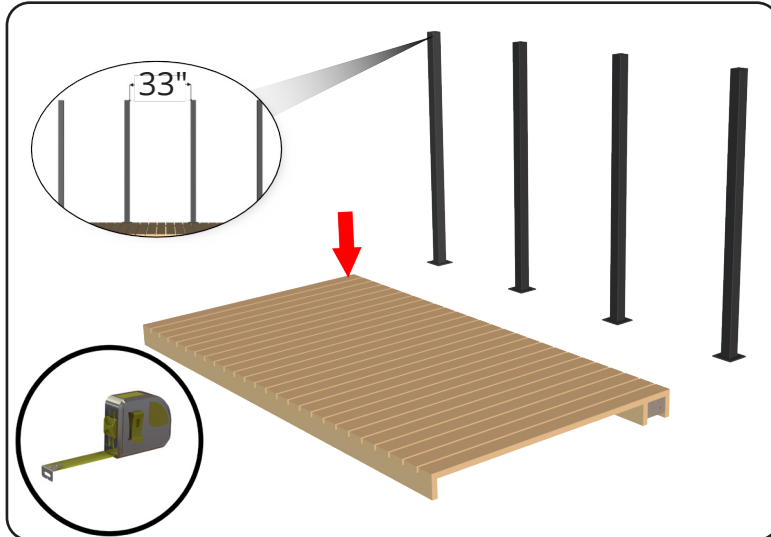

1. Place the Posts

Begin step one by placing the posts in the desired location, and measure the distance between them so that they are 33 inches apart. This will set the screens on the centerline on the face of the post.

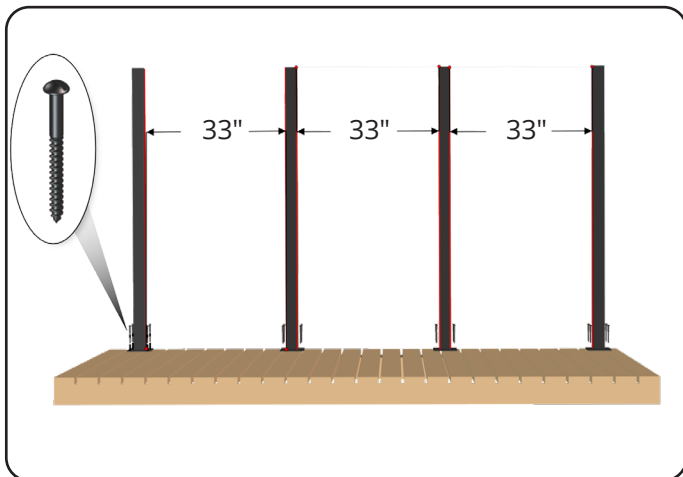

2. Fasten Posts using the GRK Sctructural Screws

After confirming your measurements, fasten the posts through the predrilled holes on the base plate into your deck surface using the GRK Structural Screws. The Lag bolts are sold separately. Choose the appropriate anchoring bolts, based on your application.

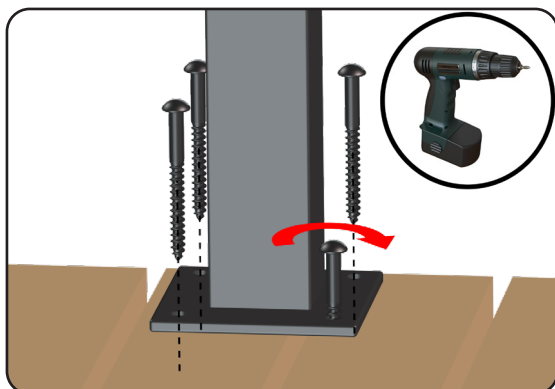

3. Secure the posts

Ensure necessary backing is provided for stability, and safety. See the engineering drawings for the recommended backing details.

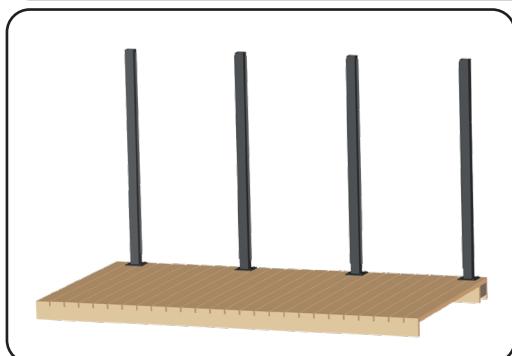

4. Level the Posts

Double check your installation is level on both side of the post. Fully fasten, and secure the posts.

After securing all posts, step 1 is now complete.

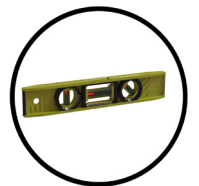

INSTRUCTIONS

Step 2 - Installing the Privacy Screen

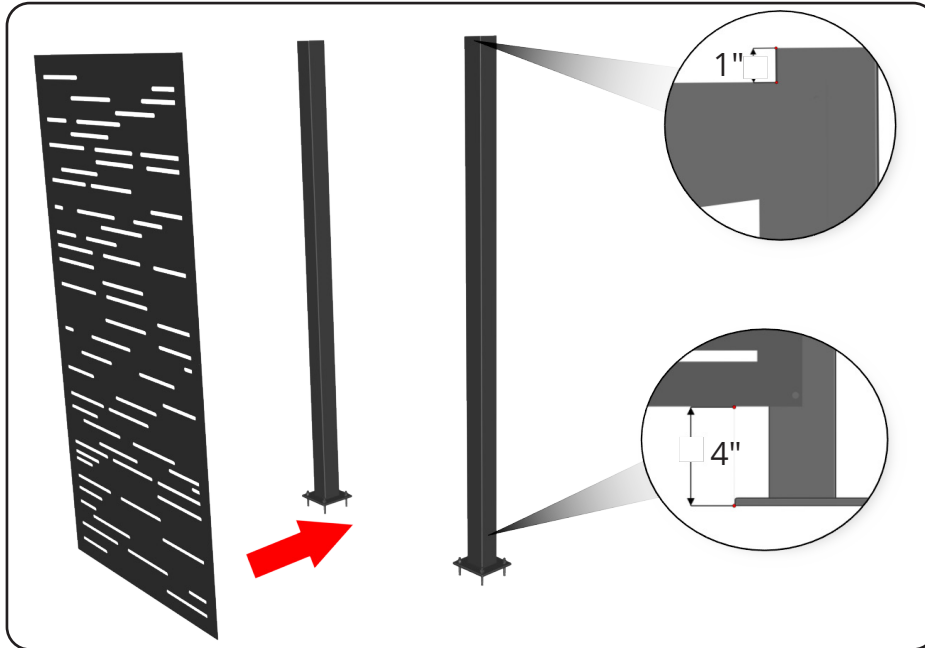

1. Install the Screens

After securing the posts, install the Hideaway Privacy Screens. With some assistance, place the screen so that it is halfway on the post, or the edge is on the centerline of the post at the desired height.

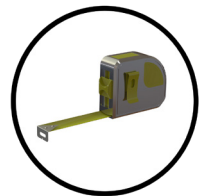

Our standard assembly sets the mounting bracket 4 inches from the ground surface, and 1 inch below the top of the post. This is also the recommended height under most building code requirements however, please ensure you comply with your local municipalities building code.

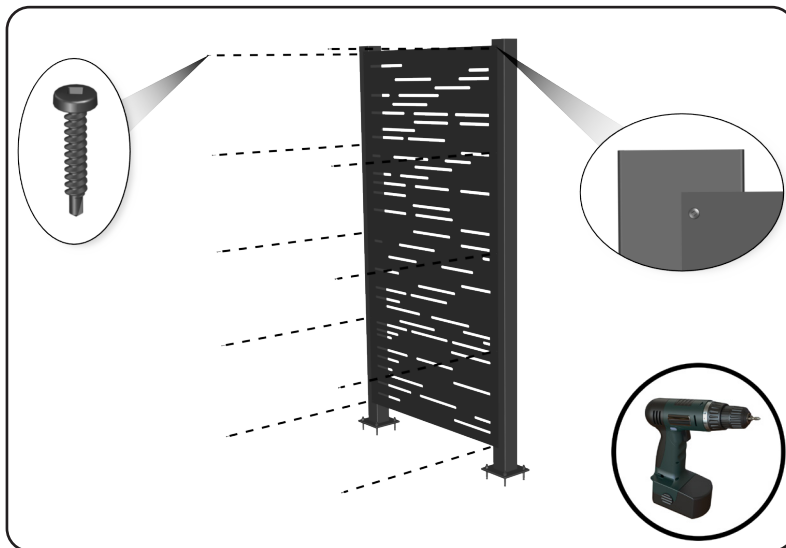

2. Secure the Screens

Ensure screens are level on installation, and affix the screen using the self-tapping screws. Fully tighten all screws.

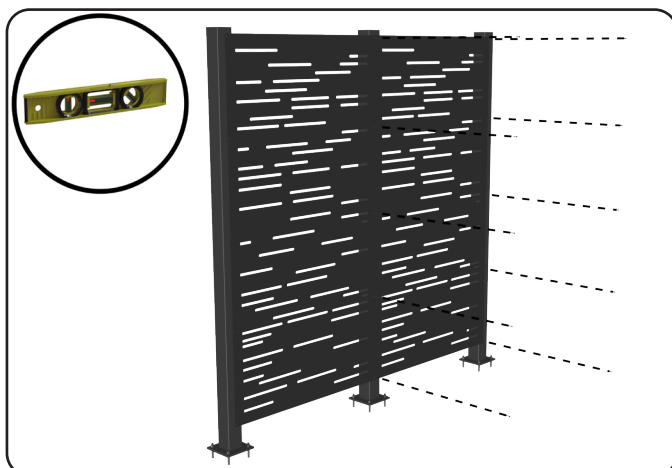

3. Install and secure all Screens

Repeat these steps, on additional screens as required per your project. After all screens are attached, you may continue to the Post Cap and Base Skirt Installation.

INSTRUCTIONS

Post Installation into Concrete Surface using Concrete Wedge Anchors

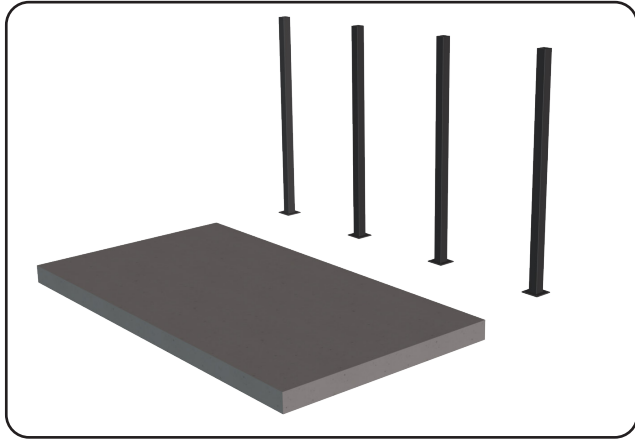

1. Place the Posts

These steps cover the installation of the Hideaway Mounting Posts into a concrete deck or patio. Please refer to the respective Installation options to determine the proper spacing between the posts.

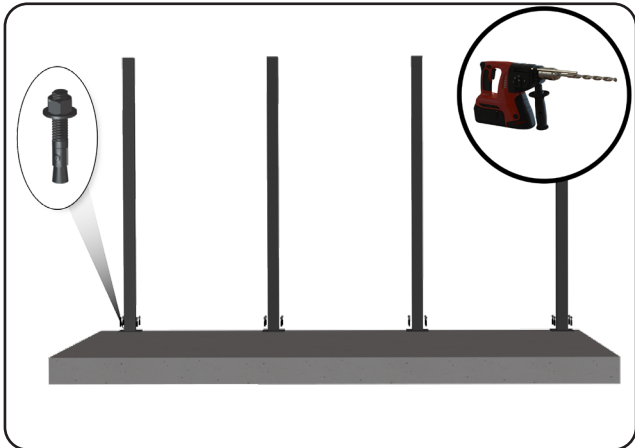

2. Drill Holes for the Wedge Anchors

After confirming your measurements, mark baseplate holes on concrete and drill holes in accordance to wedge anchor specifications. Ensure your holes are precise as incorrect placement can cause mounting issues.

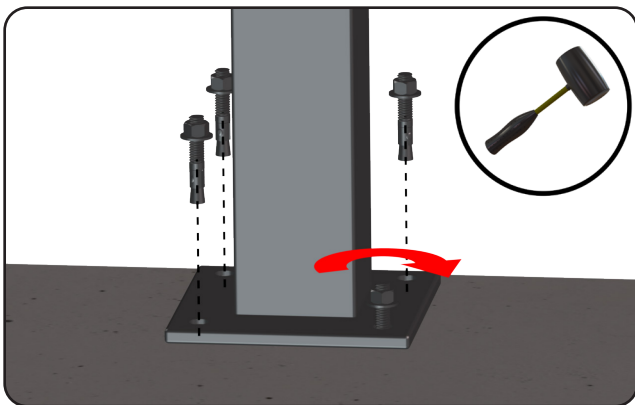

3. Place the Wedge Anchors

Once holes are drilled, place wedge anchors into holes and hammer down into place.

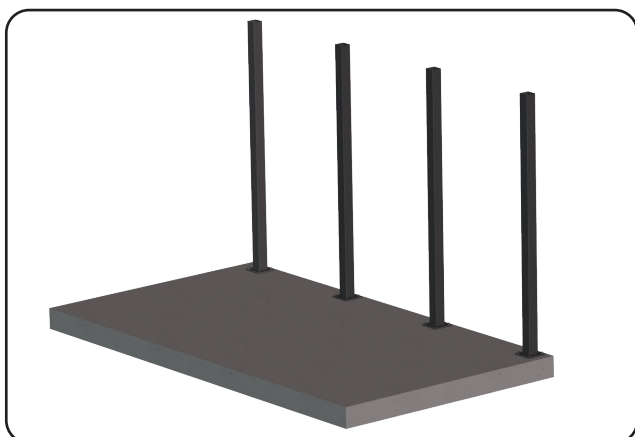

4. Secure the Posts

Fasten and secure the post to the concrete. Double check your installation with a level on both side of the post.

Refer to the respective screen installation tutorial for remainder of the assembly.

HIDEAWAY

Technical support

Get in touch with us and we'd love to answer all your questions or comments.
We have our team ready to help with anything you need.



<https://hideawayscreens.ca>



Call or Text: 1-866-933-6833



info@hideawayscreens.ca