

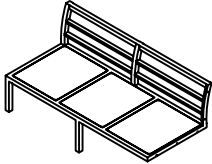

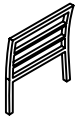

# ASSEMBLY INSTRUCTION

## BLAKES LOUNGE/DINING SET 4 PIECES

NUM	PARTS LIST	Q'TY	DESCRIPTION
A		1	3-seat open bench
B		1	Armrest for 3-seat open bench
C	 M6*30	2	Screw
D	 M6*50	2	Screw
E		4	Spacer
F		1	Alley key

**!** **Let op:** Bij het monteren van het meubel eerst alle schroeven half indraaien. Pas als alle schroeven op de plek zitten alles vast draaien.

**Note:** When assembling the furniture, first screw all screws halfway. When all the screws are in place, tighten everything.

**Achtung!** Um die Montage des Möbelstückes zu vereinfachen, erst alle Schrauben handfest andrehen und am Ende erst alle Schrauben fest anziehen.

**Attention:** Avec votre meuble, tous les visser par rapidement monter. Ci tout sur son place, vous pouvez les monter.

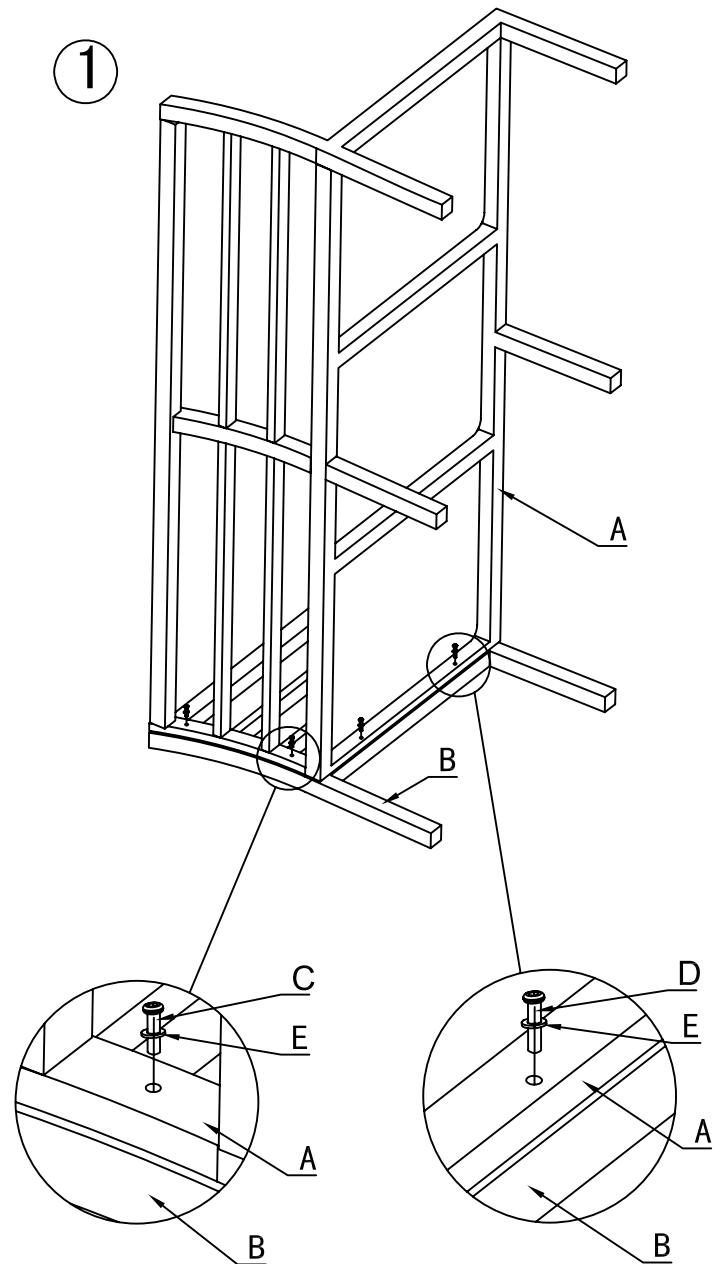

②

