

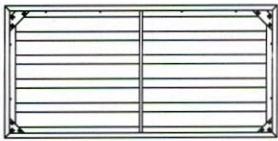

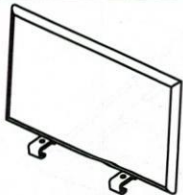

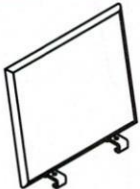









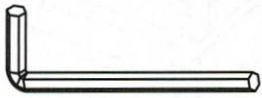

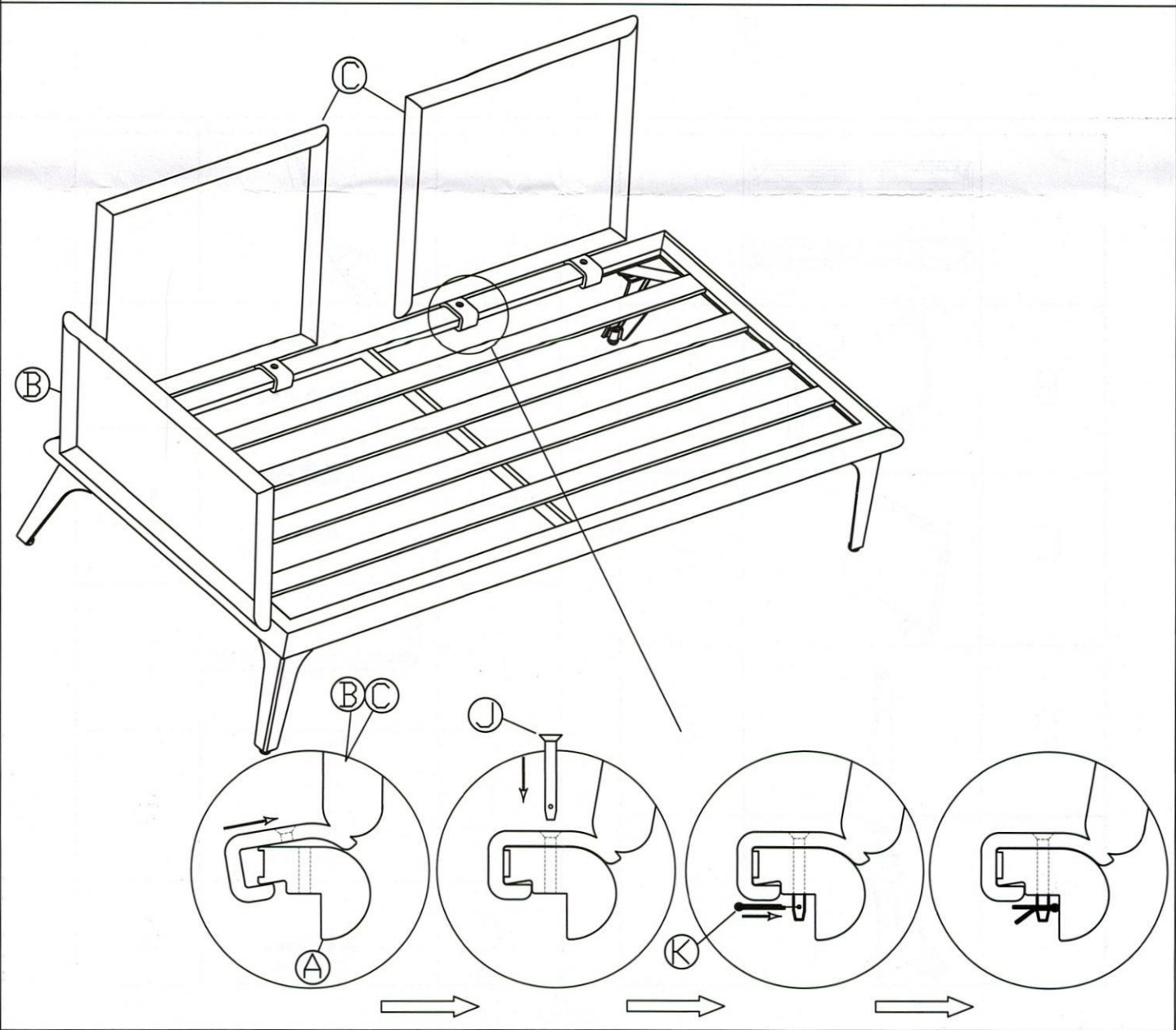
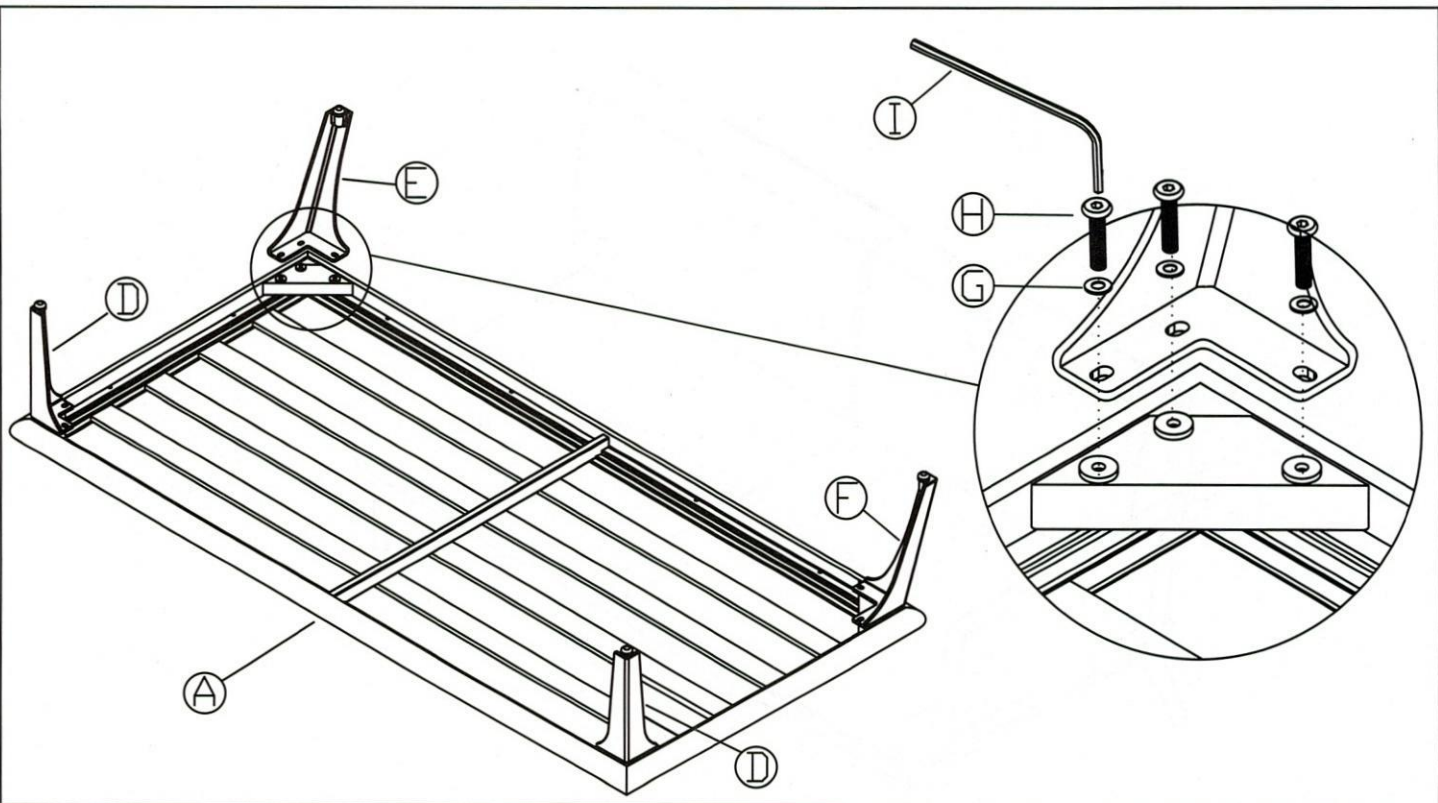
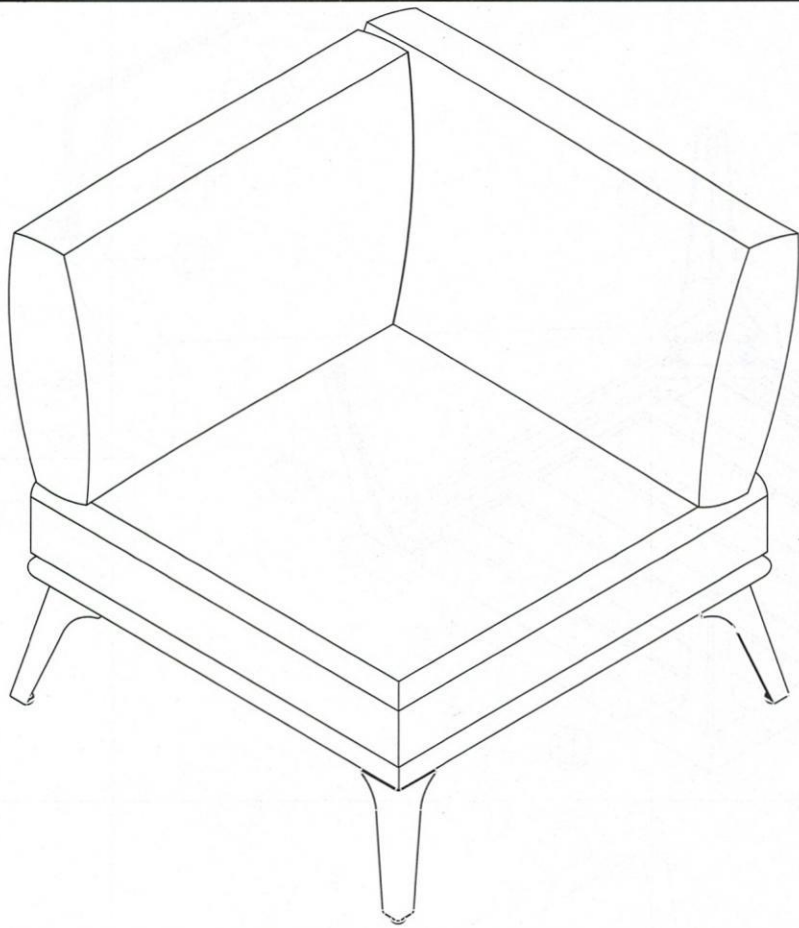

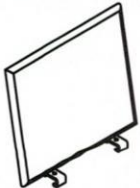

A		1
B		1
C		2
D		2
E		1

F		1
G	 Ø12*Ø6.2*1	12
H	 M6*25	12
I		1
J		6
K		6





A		1
B		2
C		1
D		1
E		1

F		1
G	 ø12*ø6.2*1	12
H	 M6*25	12
I		1
J		4
K		4

