

Rio 2.0

ADJUSTABLE BASE | OWNER'S MANUAL

Customer Service : 1-888-550-3746

Table of contents

- Safety Precautions and Usage Statements 1-3
- Parts List 4
- Base and Remote Overview 5
- Quick Reference Guide 6
- Installation Guide 7-8
- Remote Control 9
- Pairing the Remote 10
- Connecting Strap 11
- Syncing Two Bases 12
- Headboard Brackets 13
- Emergency Battery Backup Strap 14
- Troubleshooting 15

Safety precautions and usage statements

Attention: Important Safety Disclaimers

Read the following information before using this product. Failure to use a surge protection device could compromise safety or cause product malfunction and could void the electrical portion of your warranty.

TO REDUCE THE RISK OF SHOCK, BURNS, FIRE OR INJURY:

For optimal safety and operation, plug bed base into a surge protector (not included). The bed base should only be plugged directly into a wall outlet or surge protector (strongly recommended). Always unplug the base from the electrical outlet before servicing any part of the base. To reduce risk of electric shock, unplug the base before cleaning. To safely disconnect, ensure the base is in a flat position with all motors off, and unplug from power source. Keep the power cord away from heated surfaces. Never operate the base when the air openings are blocked. Keep air openings free of lint, hair and the like. Do not drop or insert any object into any opening. Discontinue use of the bed base and contact a qualified service center if: it has a damaged cord or plug, if it is not working properly, or it has been dropped into water. Only use this bed base for its intended use as described in this manual. Do not use accessories/ attachments that are not recommended by the manufacturer. Close supervision is required when the bed base is used by or near children, convalescents, disabled persons or pets. Improper connection of the equipment can result in the risk of electrical shock, electrical fire or faulty operation of this bed base. If the plug does not fit your outlet, contact a qualified electrician to install a suitable outlet. Unauthorized modification or failure to use a wall outlet or surge protector could void the electrical portion of your warranty.

SAFETY FEATURES:

Manual operation – If something gets caught in the platform when flattened, you can manually raise the platform up by lifting at both the head and foot to relieve pressure and allow for release.

Child-lockout – This remote control is programmed with a child-lock safety feature. Information on activation and deactivation of this feature can be found on the Remote Control page(s) and on the back of your remote control.

Emergency stop – Stop the motion of the platform by pressing any button on the remote control.

Power outage – Use the “Emergency Battery Backup Strap” as a temporary power source to get the base to a desired position. Instructions on how to

operate the Battery Backup Box are on the Emergency Battery Backup page(s).

CHILDREN AND PETS:

Immediately dispose of all packing materials as it may pose a smothering risk to small children and pets. To avoid injury, it is not advised to allow children and small pets to play on or under the bed. Children should not operate the bed base without adult supervision.

PACEMAKERS:

Some products contain Neodymium MAGNETS which may interfere with devices such as pacemakers, ICD’s and any other device sensitive to magnetic fields. It is STRONGLY recommended that owners of such medical devices consult their physician prior to using products that contain Neodymium MAGNETS. It is also possible that some pacemakers may falsely interpret the optional massage feature vibrations as movement/exercise. This is a common occurrence with any product that creates a vibrating movement and may affect the pacemaker. Please consult your physician before using the massage feature.

IN-HOME USE AND HOSPITAL STANDARDS:

Ergo adjustable bed bases are designed solely for in-home use. This base was not designed as a hospital bed and is not designed to meet hospital standards. Do not use this base with TENT TYPE oxygen therapy equipment or near explosive gases.

ADDITIONAL SAFETY FEATURES

Casters (optional leg accessory) are equipped with locking wheels to prevent unwanted movement. Even when locked and unable to roll, it is possible for the casters to slide. Free release head and foot motors are designed to lower the mattress by retracting only with gravity, never pulling downwards, which minimizes pinch points

LIFTING/LOWERING MECHANISMS

The lift/lower feature will emit a minimal humming sound during operation.

Safety precautions and usage statements

This is normal. During operation, the lift arm wheels make contact with the platform support of the base. This contact may result in metal on metal or metal on plastic contact. This applies slight tension on the moving components and resonance is reduced to a minimum level. If excessive noise or vibration is experienced, reverse the movement action (up or down) of the base with the remote control. This should realign the base's activating mechanisms to the proper operational position. In normal base operation, the wheels, which allow the bed to maintain its distance from the wall, will make contact with the steel platform supports of the base creating a contact noise. When entering, exiting or shifting weight on the base, this contact noise may be audible as the wheels make contact. This is normal.

MATERIALS

Ergo adjustable bases are constructed from various materials including woods, metals, plastics and fabrics. Tension, pressure or movement applied to the frame, platform or shroud through general use may create an audible sound.

TOLERANCE

All Ergo adjustable foundations, depending on make and model, are designed and manufactured to perform and function within designated quality control parameters. Bases are subject to meticulous and rigorous inspections during the quality control process to ensure bases will operate within these standards during normal operating use. Normal operating use is defined as the following: Adjustable foundation is to be operated with a mattress and load. Testing procedures require lifetime cycle tests with up to 120kg distributed load. The angle (designated " α " in figure 1) between the back section and the flat section for various configurations of the mattress support platform shall be $\pm 3^\circ$, which translates to a tolerance of up to $1 \frac{1}{2}''$.

The angle (designated " β " in figure 1) between the flat section and foot section for various configurations of the mattress support platform shall be $\pm 3^\circ$, which translates to a tolerance of up to $\frac{3}{4}''$.

Any adjustable foundation deemed to be within these allocated tolerances is considered to have met the manufacturer's quality control standards.

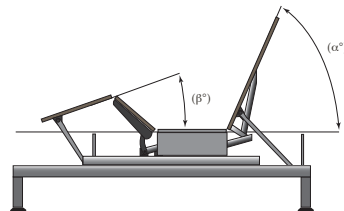

THAT "NEW PRODUCT" SMELL:

Some people notice a slight odor to their new adjustable base—this can come from our material manufacturing process. This smell is normal and usually disappears before the product reaches you. Sometimes, however, this smell may still be noticeable. It usually disappears after a few weeks, providing adequate ventilation of the product and the environment.

BREAK IN PERIOD:

You can speed up the break-in period by simply spending time in the adjustable bed through activities such as reading, watching TV or playing with the kids or grandkids. The extra movement will help the adjustable base respond to weight and temperature changes. Some of the materials in our adjustable bases such as the woods, metals and plastics used in the platform, frame and components are sensitive to moisture content and temperature and may make sounds in colder environments.

PAIRED OPERATION:

When operating a "paired" split base setup there may be a time latency up to 1.5 seconds between each bases articulation.

WEAR AND TEAR:

Wear and tear is damage that naturally and inevitably occurs as a result of normal use or aging.

FABRIC CARE:

To prolong the life of your fabric, protect from direct sunlight whenever possible. For spot cleaning, wipe area with a light damp sponge or vacuum with a soft brush attachment to remove particles. Keep at a minimum of 30cm (12 inches) away from direct heat sources. For a deeper cleaning, blot liquid spills with a clean dry cloth. Wipe with a clean cloth dampened with warm water. Do not wet excessively. A soft bristle brush may be used to remove ingrained soil. Avoid scratching by gentle brushing. Wipe with a clean cloth dampened with warm water to remove residues. Dry in shade away from direct heat. If persistent marks remain visible after cleaning, seek professional advice.

PRODUCT RATINGS:

The lift motors are not designed to operate continuously for more than [2] minutes in an [18] minute time period or approximately 10% duty cycle.

Safety precautions and usage statements

Attempting to circumvent or exceed this rating will shorten the life expectancy of the product and may void the warranty. The massage motors are not designed to operate continuously for more than 30 minutes at a time. Please allow the massaging system to rest for 30 minutes after automatic massage shut off before restarting.

WEIGHT LIMITS:

This product is not rated to support weights in excess of 750 pounds. The base will structurally support this weight, provided it is evenly distributed across the bed base. The adjustable base is not designed to support or lift this amount in the head or foot sections alone. Exceeding this weight restriction could damage the bed and/or cause injury and will void the warranty.

SAVE THESE INSTRUCTIONS.

FCC Compliance:

NOTE: This equipment has been tested and found to comply with the limits for a Class B digital device, pursuant to part 15 of the FCC Rules. These limits are designed to provide reasonable protection against harmful interference in a residential installation. This equipment generates, uses and can radiate radio frequency energy and, if not installed and used in accordance with the instructions, may cause harmful interference to radio communications. However, there is no guarantee that interference will not occur in a particular installation. If this equipment does cause harmful interference to radio or television reception, which can be determined by turning the equipment off and on, the user is encouraged to try to correct the interference by one or more of the following measures:

- Reorient or relocate the receiving antenna.
- Increase the separation between the equipment and receiver.
- Connect the equipment into an outlet on a circuit different from that to which the receiver is connected.
- Consult the dealer or an experienced radio/TV technician for help.

Parts list

Before discarding the packing materials - ensure all the parts are accounted for.

All electronics and components that need to be installed are located in boxes under the base or attached to the frame.

- A) Wireless Remote Control (1)
- B) Mattress Retainer Bar (1)*
- C) Legs (6)
- D) Power Cord (1)
- E) Power Supply (1)
- F) Sync Cord ‡
- G) Battery Backup Strap (1)
(2) 9V Alkaline Batteries (not included)
- H) Connecting Strap‡

Misc Parts (not included):

- I) Surge Protector







Headboard Bracket Components (Optional):



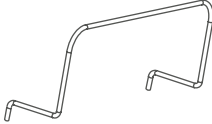

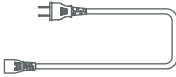
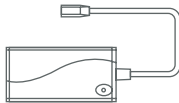
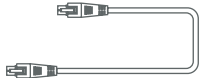

- J) Headboard Bracket (2)†
- K) T-Bracket (2)†
- L) Long Bolts (8)†
- M) Short Bolts (6)†
- N) Wingnuts (2)†
- O) Washers (2)†
- P) Hex Key (1)†

* These items are attached to the base for shipping purposes. Carefully remove from base and set aside.

‡ Only included in Twin Long and Cal King Split bases.

† This is an optional item and can be purchased (1-888-550-3746)

A) 	B)* 	C) 
D) 	E) 	F) ‡ 
G) 	H) ‡ 	I) 

HEADBOARD BRACKET COMPONENTS (Optional)			
J)† 	K)† 	L)† 	
M)† 	N)† 	O)† 	P)† 

Base and remote overview

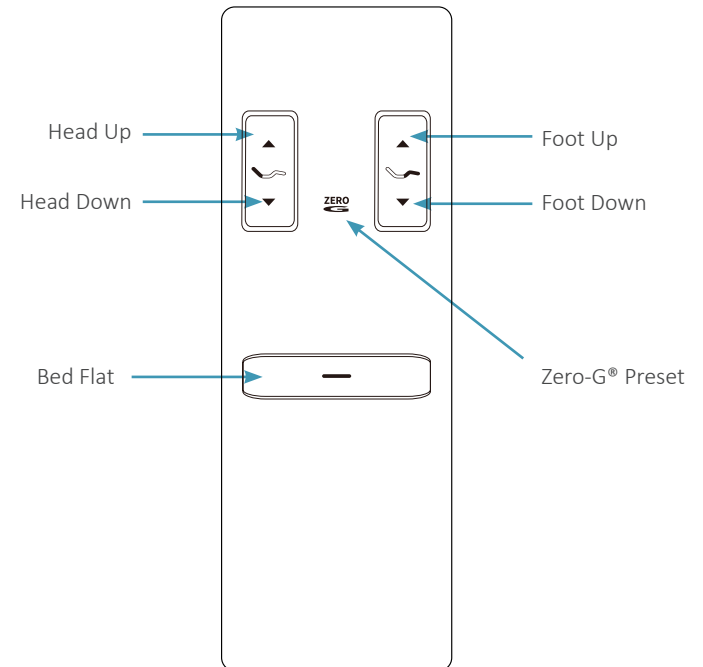
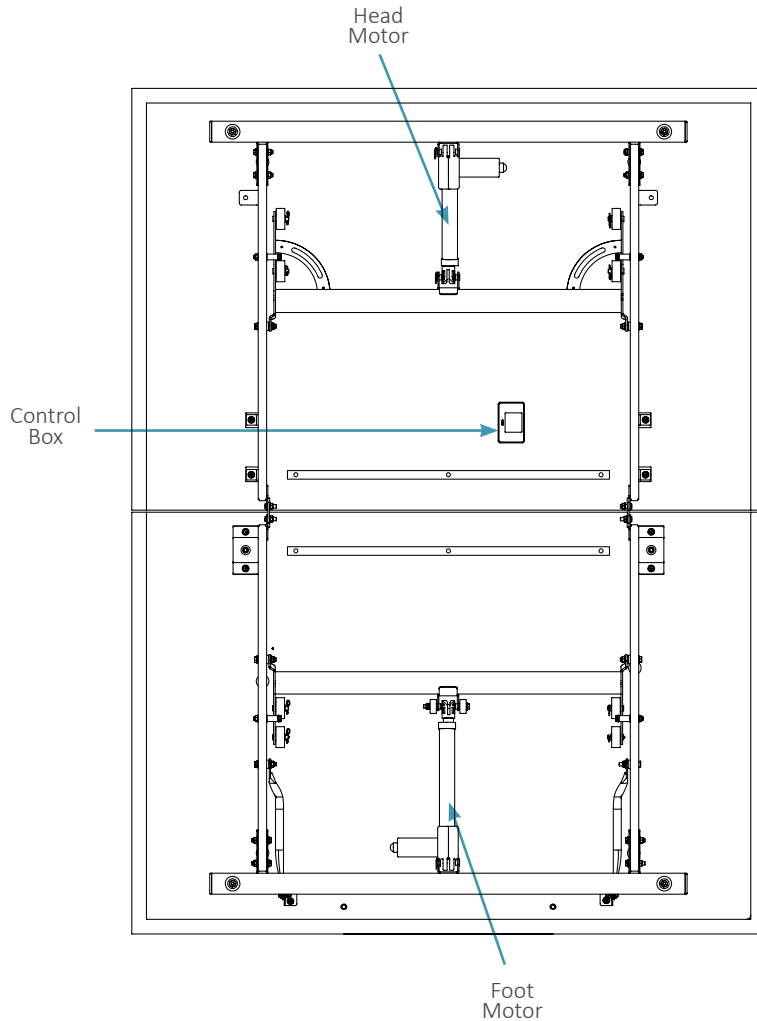

Quick reference guide

Not to scale. For illustration purposes only. Read all instructions before beginning installation.

ELECTRONICS OVERVIEW

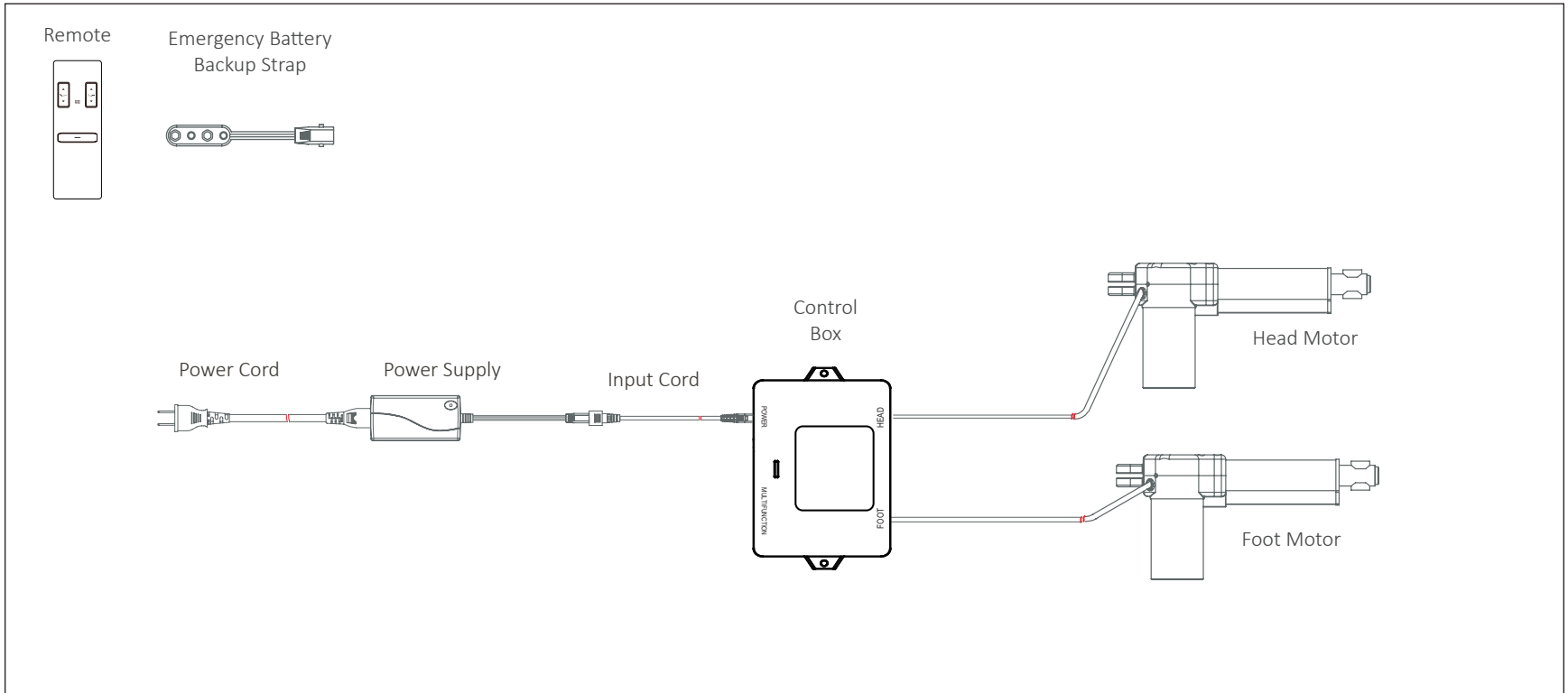

If installing a split unit, see pages 11-12.

Installation guide

Always use two people when setting up the base.

STEP 1

Place the bed base box in a desired location with the bottom of the box facing up.

Remove the binding straps and packing materials, making sure not to puncture the box with any sharp objects.

STEP 2

Remove the bed base from the box. Unfold the bed making sure to keep the bottom of the bed facing upwards.

STEP 3

To install headboard brackets (sold separately), see instructions on page 13.

Legs are shipped fully assembled. Alternative heights in 3" increments can be achieved by removing leg segments.

To install the legs, thread the leg into frame, and tighten by hand. **Do not over tighten.**

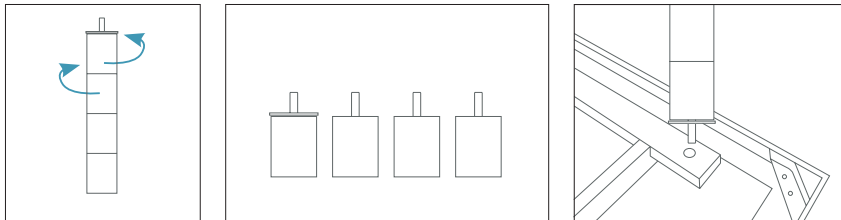

STEP 4

If installing a split unit, see pages 11-12.

Locate the battery backup strap and install (2) 9V Alkaline batteries (not included). Store the strap in a convenient location in case of an emergency power outage.

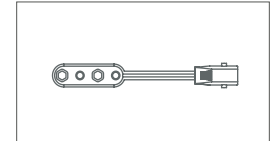

(For operating instructions see page 14).

STEP 5

Uncoil input power cord (connected to control box's power port) and plug into power supply.

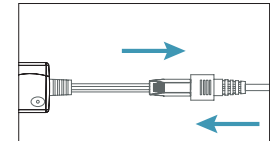

STEP 6

Uncoil the power cord and connect to the power supply. Place power supply on the ground and extend from the base. Ensure that the power supply and all attached cords are directed toward the desired surge protector.

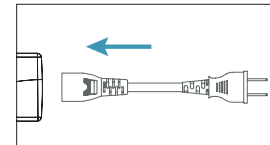

Installation guide

STEP 7

Carefully flip the base over on to its legs. Important: Two people are required to move the bed base. Do not drag across the floor. Do not rest frame on its side, excessive pressure may damage the legs.

STEP 8

Plug the power cord into a power source. **A surge protector is recommended.**

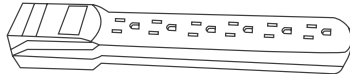

STEP 9

Ensure batteries are correctly installed in the back of the remote.

Quickly test functions to verify proper setup before placing mattress on base. Return the base to a flat position before placing the mattress on top.

STEP 10

Insert the ends of the mattress retainer bar into the holes at the foot of the platform.

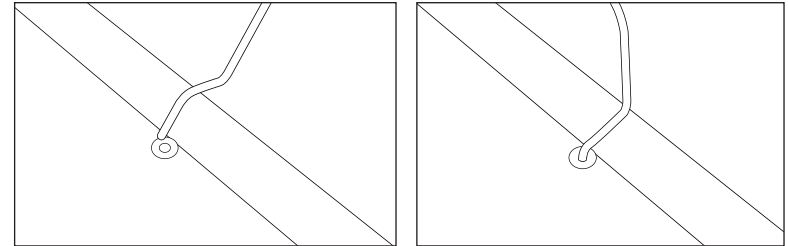

Setup is now complete! Test all functions on remote.

Remote control

Remote Control arrives paired to the adjustable base.

Three (3) AAA batteries are required to operate the remote.

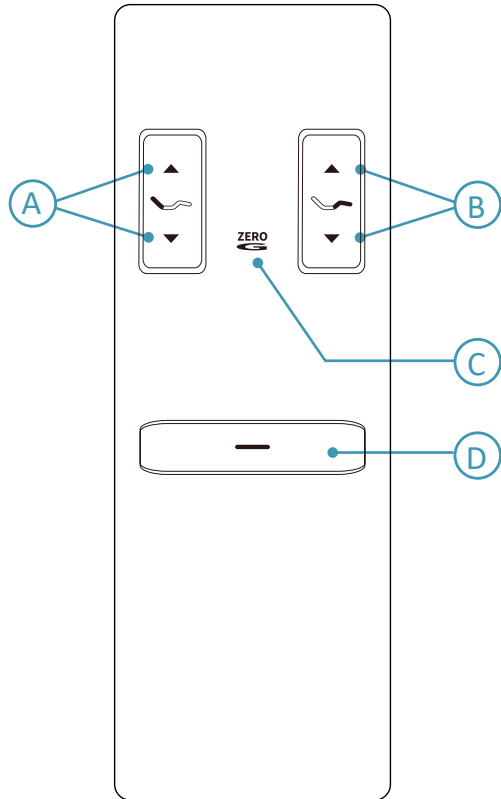

BUTTON FUNCTIONS

- A. Head Articulation: Raises and lowers the head end of the adjustable base.
- B. Foot Articulation: Raises and lowers the foot end of the adjustable base.
- C. Zero-G®: Preset position that adjusts your legs to a higher level than your heart helping to relieve pressure off the lower back and promote circulation.
- D. Flat: Return the adjustable base to a flat position.

Remote control pairing & child lock

REMOTE PAIRING

Note: The original remote that comes in the box is already paired to the adjustable base. No further action is required. In the event that the remote is not paired with the base, follow the steps below.

STEP 1

Unplug the Power Cord from your power outlet. Wait 1 minute, then plug it back in to your power outlet. Perform Step 2 within 10 seconds, while the control box light is flashing.

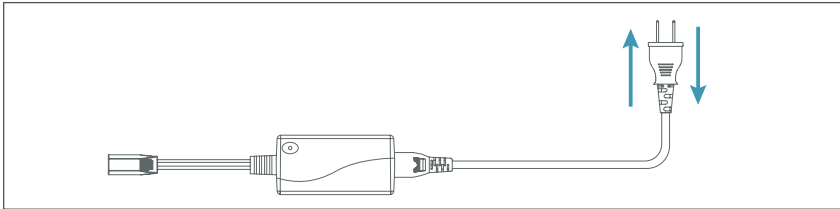

STEP 2

Remove the cover on the back of the remote and hold the PAIR button. The PAIR button will illuminate and start to flash. When the PAIR button stops flashing, the pairing LED light on the control box will stop illuminating. Release the PAIR button on the remote.

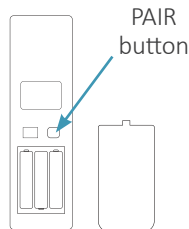

STEP 3

Test all remote functions. If the remote buttons do not impact the adjustable base movements, please repeat the process again or call Ergomotion customer service: 1-888-550-3746

CHILD LOCK

ACTIVATE CHILD LOCK:

Press and hold FLAT and HEAD UP buttons for 3 seconds. When the backlight on the remote flashes 2 times, that means the lock is completed.

When a button is pressed in Child Lock mode, the backlight on the remote will flash twice.

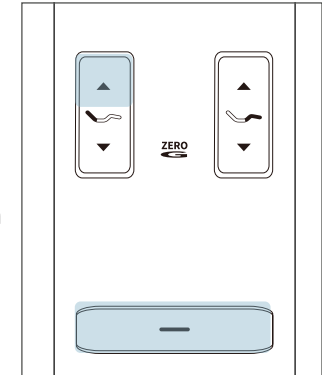

DEACTIVATE CHILD LOCK:

Press and hold FLAT and FOOT UP buttons for 3 seconds. When the backlight on the remote flashes 2 times, that means the unlock is completed.

The remote will now operate normally.

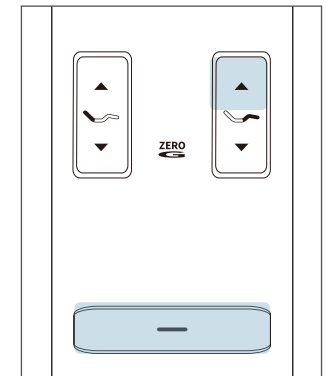

Connecting strap (optional)

If a split setup is being installed, optional plastic connecting straps can be used to help secure the bases together. To purchase optional accessories, please call 1-888-550-3746.

STEP 1

With the bases in their desired location, slightly loosen both legs to allow the strap to fit on the leg bolt, between the leg washer and frame.

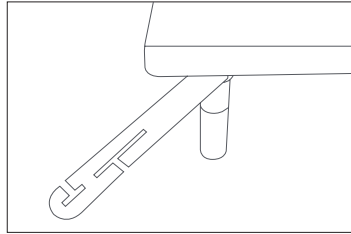

STEP 3

Re-tighten legs. Do not over tighten. Use the remaining strap and repeat on other end of the base.

STEP 2

Slide side (a) of the connecting strap onto leg bolt. Swing the strap and connect side (b) to the leg bolt. Secure the strap by shifting to the left.

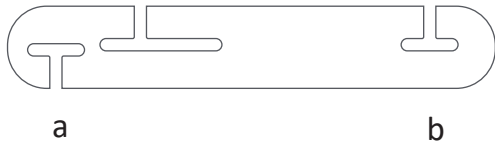

Syncing two bases (optional)

A Sync Cord is included with the base. Not available on Queen, Full or Full-Long size bases.

The Sync Cord connects the two control boxes to a single remote for the synchronization of two bases.

This process is most commonly used for syncing two connected TXL bases.

STEP 1

Unplug the base(s) from power source.

STEP 2

Connect the Sync Cord to the Multifunction port of each Control Box.

STEP 3

Plug bases back into the power source.

STEP 4

Check to ensure all cords are securely attached. Both remotes will now operate both bases simultaneously.

The system is now linked. Pressed buttons on either remote will control the two bases simultaneously.

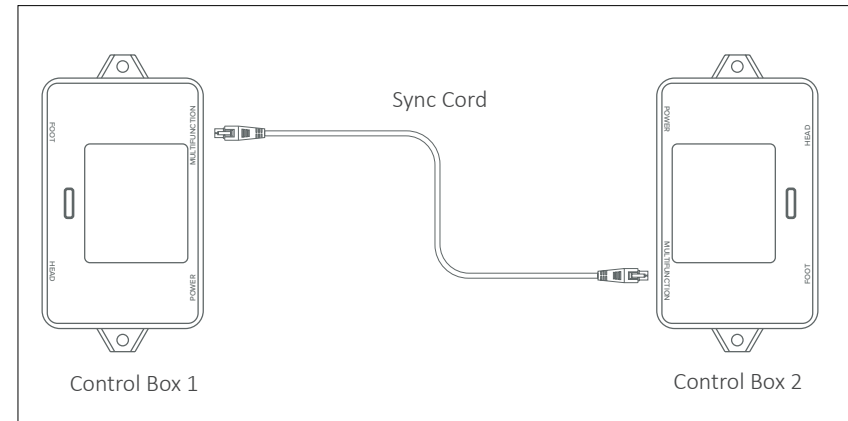

PERFORMANCE NOTES

If bases become mismatched, returning the bases to the flat positions will re-sync the mechanical positions.

Headboard bracket installation guide (optional)

Headboard Brackets are an optional accessory and are not included.
A hex key is included with the accessory kit to complete installation.

STEP 1

- Align the hole in the bracket to the brass sleeve into which the leg threads. Hold the bracket in place and screw the leg into the base until it is snug. **DO NOT OVERTIGHTEN.** Too much force may cause the leg to spin freely.
- Align the tab with the hole in the frame (located towards the foot of the base) and use a short bolt, washer and wingnut to secure the bracket. Make sure the bolt is tight.

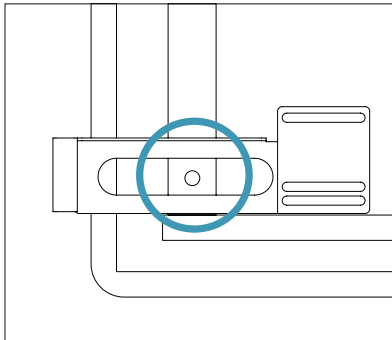

STEP 2

- Measure the distance between the mounting holes on the headboard and install the T-Bracket to accommodate the headboard.
- To install the T-Bracket, slide the T-Bracket through the end of the headboard bracket. Align the flat side of the T-Bracket plate to the mounting holes on the headboard.
- Secure T-Bracket in place by inserting two short screws through top of bracket. Use hex key to tighten screws.

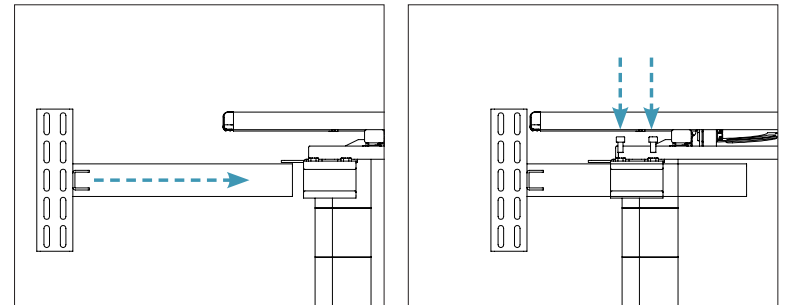

STEP 3

Connect your headboard to the attachment plate using the remaining long screws or hardware that came with your headboard. The heads of the bolts will face outward. Use hex key to tighten bolts.

Battery backup strap (optional)

For emergency use only, in case of a power outage.

Batteries are not to be used for normal operation of the bed.

STEP 1

Disconnect the Power Supply from the input power cord.

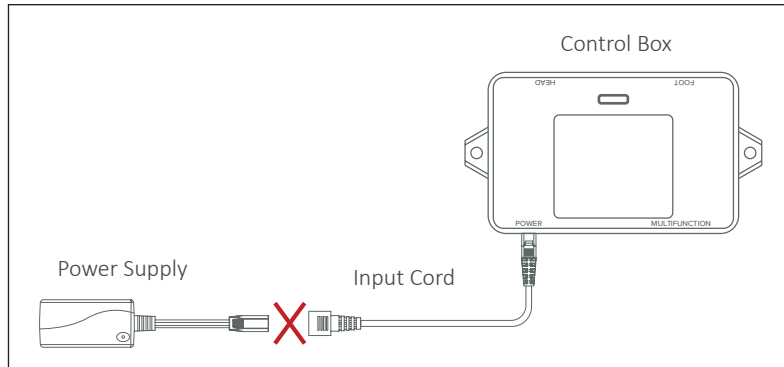

STEP 3

Connect the Battery Backup Strap to the (2) Alkaline 9 Volt batteries. Do not mix brand name Batteries.

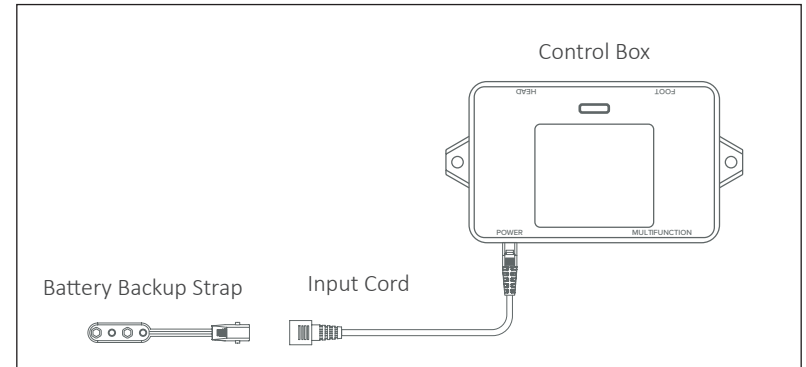

STEP 2

Connect the Battery Backup Strap to the (2) Alkaline 9 Volt batteries. Do not mix brand name Batteries.

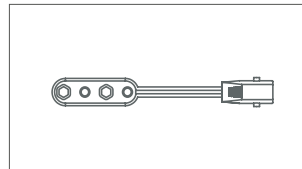

STEP 4

Use the remote to return the base to a flat position.

Note: Detach the Battery Backup Strap and reconnect the power supply after the emergency is over, as the system will continue to draw power from the batteries even if not in use.

Troubleshooting

If one or more functions on the bed base have stopped operating:

- Check under the bed base to verify that the wired connections are secure and that there are no cords or bedding obstructing the movement of the base.
- Check to ensure the green LED light is illuminated on the power supply. If there is no light, verify that the input and power cords are properly connected.
- Unplug the base for 1 minute to reset the electronic components.
- Ensure Child Lock feature is not enabled. See page 10 for more information.
- Plug bed base into a different electrical outlet, or test current outlet with another working appliance (a grounded, electrical surge protector is recommended).

If issue is not resolved by following the instructions above, locate serial number on warranty card or back of remote and call

[Ergomotion Customer Service: US 1-888-550-3746](tel:1-888-550-3746)

Nationwide Customer Service

Phone 1.888.550.3746
Email info@ergomotion.com
Web www.ergomotion.com

Serial Number:

+ +
+ +