

ADJUSTABLE BASE QUICK ASSEMBLY GUIDE

NO TOOLS REQUIRED FOR ASSEMBLY

Use caution at pinch points while unfolding the base as parts may have shifted during shipping.

Unpack components for assembly:

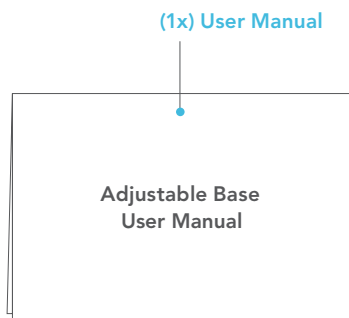

(6x) 12" Legs



(1x) Mattress Retainer Bar
with (2x) Wing Nuts

(1x) AC/DC Power
Adapter per Base

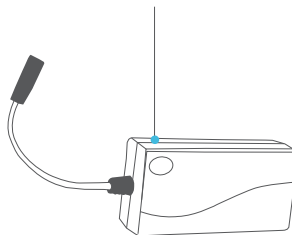

(1x) Power Cord
Input voltage 100-240V per base

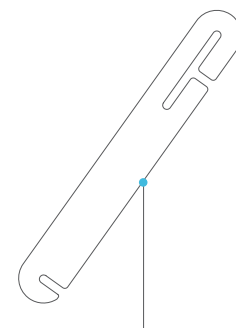
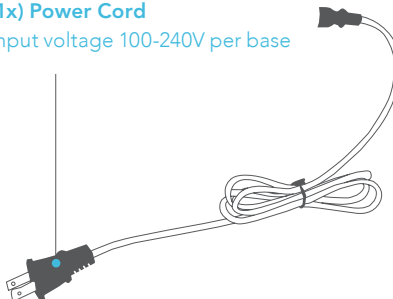

(1x) Connecting Straps
(TXL & CKS sizes only)

ADJUSTABLE BASE QUICK ASSEMBLY GUIDE

STEP 1: POWER CORD SETUP

CAREFULLY open the adjustable bed base into an L position on its side or lay flat with the bottom facing up. This step may require two adults for safety.

Ensure power cord connection circled is completely plugged-in.

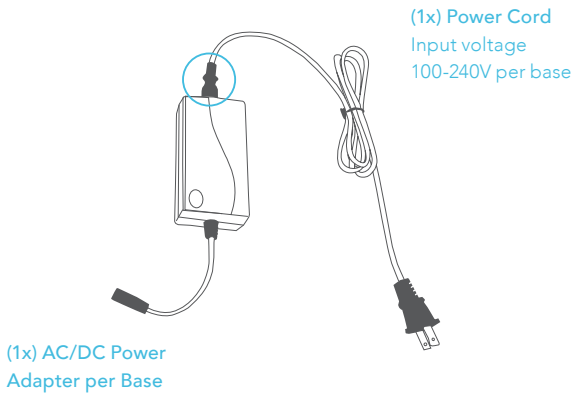

STEP 3: INSTALL MATTRESS RETAINER BAR

Slide the retainer bar into the opening at the foot of the bed. Secure the retainer base (Figure 1) with the included wing-nuts (Figure 2).

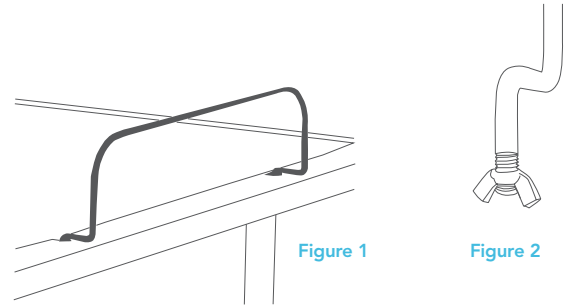

STEP 2: ASSEMBLE LEGS

Make sure the leg with the solid end is touching the floor. Screw six legs into the pre-drilled holes by hand. All legs must be installed and resting evenly on the floor. The base will not operate properly without the legs.

Violating safety guidelines may result in damage or injury, void the warranty for improper use and may cause damage to the floor.

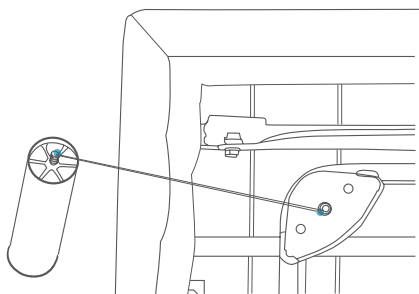

STEP 4: RETURN TO UPRIGHT POSITION

CAREFULLY place the adjustable bed base onto all six legs and plug the power cord into a power outlet. Place a mattress on the adjustable base once the bed is plugged in and functioning correctly. Use a memory foam, latex or acceptable hybrid mattress at least 8" in height.

See manual for Connecting Strap instructions for Split King/Cal King Bases.