



KitchenAid

Food Processor
5KFP1318*
5KFP1319*



EN	Use & Care manual	2	FI	Käyttö- ja huolto-opas	167
DE	Gebrauchs- und Pflegeanleitung	19	DA	Vejledning til anvendelse og vedligehold	183
FR	Manuel d'utilisation et d'entretien	36	IS	Notenda & Meðhöndlunar handbók	199
IT	Manuale d'uso e manutenzione	55	RU	Руководство по эксплуатации и уходу	215
NL	Gebruiks- en onderhoudshandleiding	71	PL	Instrukcja obsługi i konserwacji	231
ES	Manual de uso y cuidado	87	CS	Návod k použití a údržbě	247
PT	Manual de utilização e manutenção	103	TR	Kullanım ve Bakım kılavuzu	263
EL	Εγχειρίδιο Χρήσης και Φροντίδας	119	UK	Посібник із використання й догляду	279
SV	Handbok för skötsel och användning	135	AR	دليل الاستخدام والعناية	1
NO	Håndbok for bruk og vedlikehold	151			





PARTS AND FEATURES

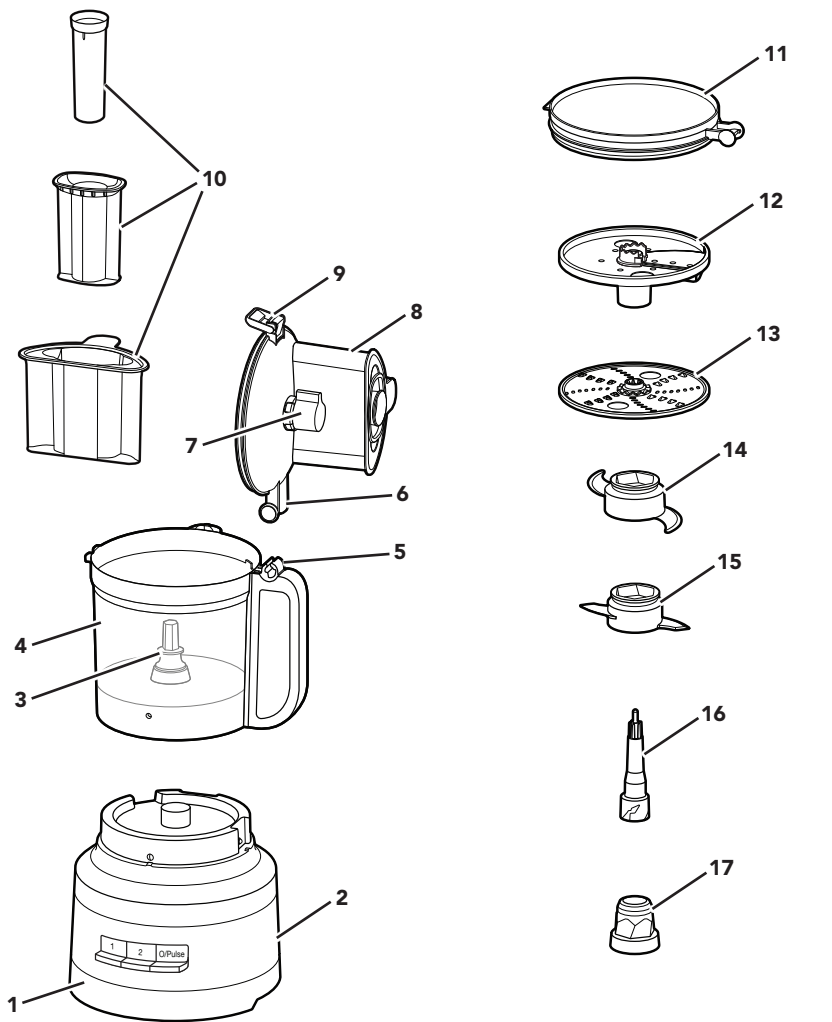

- | | | | |
|---|---|----|--|
| 1 | Heavy-Duty Base | 10 | 3-in-1 Food Pusher |
| 2 | Power Cord and Cord Storage (not shown) | 11 | Refrigerator Lid |
| 3 | Drive Pin | 12 | Externally Adjustable Slicing Disc (thin to thick) |
| 4 | 13-Cup (3.1 L) Work Bowl | 13 | Reversible Fine/Medium Shredding Disc |
| 5 | Handle Hinge | 14 | Multipurpose Stainless Steel Blade |
| 6 | Lid Hinge | 15 | Dough Blade |
| 7 | Slicing Knob | 16 | Drive Adapter (Upper) |
| 8 | Work Bowl Cover with 3-in-1 Feed Tube | 17 | Drive Adapter (Lower) |
| 9 | Lid Latch | | |





PARTS AND FEATURES

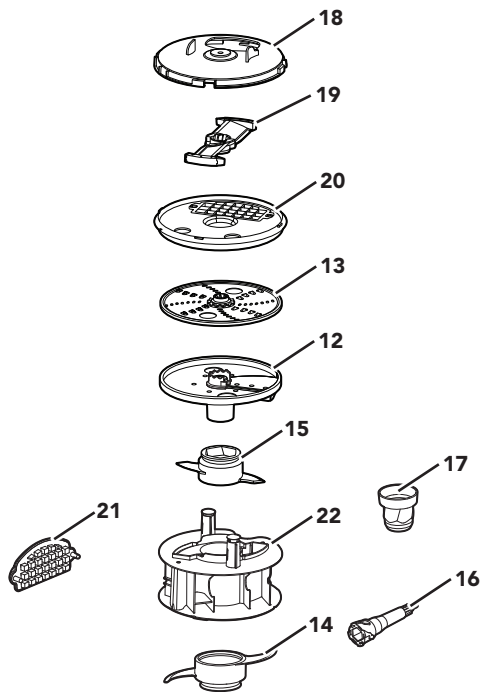

- 18** Dicing Kit Cover
- 19** Dicing Blade
- 20** Dicing Kit Base
- 21** Dicing Kit Clean Out Tool
- 22** Storage Caddy

ACCESSORY GUIDE

Accessory	Included with Model	
	5KFP1319*	5KFP1318*
External Adjustable Slice	•	•
Storage Caddy	•	•
Wide Mouth Opening	•	•
3-in-1 Feed Tube	•	•
Multipurpose Blade	•	•
Dough Blade	•	•
Thin and Medium Shred	•	•
Storage Lid	•	
Dicing Kit	•	





PRODUCT SAFETY

Your safety and the safety of others are very important.

We have provided many important safety messages in this manual and on your appliance. Always read and obey all safety messages.



This is the safety alert symbol.

This symbol alerts you to potential hazards that can kill or hurt you and others.

All safety messages will follow the safety alert symbol and either the word "DANGER" or "WARNING." These words mean:

 **DANGER**

You can be killed or seriously injured if you don't immediately follow instructions.

 **WARNING**

You can be killed or seriously injured if you don't follow instructions.

All safety messages will tell you what the potential hazard is, tell you how to reduce the chance of injury, and tell you what can happen if the instructions are not followed.

IMPORTANT SAFEGUARDS

When using electrical appliances, basic safety precautions should always be followed, including the following:

1. Read all instructions. Misuse of appliance may result in personal injury.
2. To protect against risk of electrical shock, do not put Food Processor in water or other liquid.
3. This appliance is not intended for use by persons (including children) with reduced physical, sensory or mental capabilities, or lack of experience and knowledge, unless they are closely supervised and instructed concerning use of the appliance by a person responsible for their safety. Close supervision is necessary when any appliance is used by or near children.
4. Turn the appliance OFF, then unplug from the outlet when not in use, before assembling or disassembling parts and before cleaning. To unplug, grasp the plug and pull from the outlet. Never pull from the Power Cord.
5. Avoid contacting moving parts.
6. Do not operate any appliance with a damaged cord or plug or after the appliance malfunctions, or is dropped or damaged in any manner. Return appliance to the nearest Authorised Service Centre for examination, repair, or electrical or mechanical adjustment.
7. The use of attachments not recommended or sold by KitchenAid may cause fire, electric shock, or injury.
8. Do not use outdoors.
9. Do not let cord hang over edge of table or counter.
10. Keep hands and utensils away from moving Blades or discs while processing food to reduce the risk of severe injury to persons or damage to the Food Processor. A scraper may be used but must be used only when the Food Processor is not running.
11. Blades are sharp. Handle Carefully. Care should be taken when handling the sharp cutting blades, emptying the bowl and during cleaning.





PRODUCT SAFETY

12. To reduce the risk of injury, never place cutting Blade or discs on Base without first putting bowl properly in place.
13. Be certain Cover is securely locked in place before operating the Food Processor.
14. Never feed food by hand. Always use the Food Pusher.
15. Do not attempt to defeat the Cover interlock mechanism.
16. Do not fill the bowl above the marked maximum fill line to avoid risk of injury due to damage to the Cover or bowl.
17. Children should be supervised to ensure that they do not play with the appliance
18. Never leave the appliance unattended while it is in operation.
19. European Union Only: This appliance shall not be used by children. Keep the appliance and its cord out of reach of children.
20. European Union only: Appliances can be used by persons with reduced physical, sensory or mental capabilities or lack of experience and knowledge if they have been given supervision or instruction concerning use of the appliance in a safe way and if they understand the hazards involved. Children shall not play with the appliance.
21. If the supply cord is damaged, it must be replaced by the manufacturer, its service agent or similarly qualified persons in order to avoid a hazard.
22. Be careful if hot liquid is poured into the Food Processor as it can be ejected out of the appliance due to a sudden steaming.
23. Refer to the "Care and Cleaning" section for instructions on cleaning the surfaces in contact with food.
24. This appliance is intended to be used in household and similar applications such as:
 - staff kitchen areas in shops, offices, or other working environments;
 - farmhouses;
 - by clients in hotels, motels and other residential type environments;
 - bed and breakfast type environments.

SAVE THESE INSTRUCTIONS

Instructions are also available online, visit our website at:
www.KitchenAid.co.uk or www.KitchenAid.eu



PRODUCT SAFETY

ELECTRICAL REQUIREMENTS

Voltage: 220-240 V~

Frequency: 50-60 Hz

NOTE: This Food Processor is equipped with a polarized plug (one Blade is wider than the other). To reduce the risk of electrical shock, this plug will fit in a polarized outlet only one way. If the plug does not fit fully in the outlet, reverse the plug. If it still does not fit, contact a qualified electrician. Do not modify the plug in any way.

DISPOSAL OF PACKING MATERIAL

The packing material is recyclable and is marked with the recycle symbol . The various parts of the packing must therefore be disposed of responsibly and in full compliance with local authority regulations governing waste disposal.

ELECTRICAL EQUIPMENT WASTE DISPOSAL

Recycling the product

- This appliance is marked in compliance with law in the EU and UK covering, Waste Electrical and Electronic Equipment (WEEE).

- By ensuring this product is disposed of correctly, you will help prevent potential negative consequences for the environment and human health, which could otherwise be caused by inappropriate waste handling of this product.



- The symbol  on the product or on the accompanying documentation indicates that it should not be treated as domestic waste but must be taken to an appropriate collection centre for the recycling of electrical and electronic equipment.

For more detailed information about treatment, recovery and recycling of this product, please contact your local city office, your household waste disposal service or the shop where you purchased the product.

DECLARATION OF CONFORMITY (UK)

This appliance has been designed, constructed and distributed in compliance with the safety requirements of UK Legislation: Electrical Equipment (Safety) Regulations 2016, Electromagnetic Compatibility Regulations 2016. The Ecodesign for Energy-Related Products and Energy Information (Amendment) (EU Exit) Regulations 2019. The Restriction of the Use of Certain Hazardous Substances in Electrical and Electronic Equipment Regulations 2012.

DECLARATION OF CONFORMITY (EU)

This appliance has been designed, constructed, and distributed in compliance with the safety requirements of EC Directives: Low Voltage Directive 2014/35/EU, Electromagnetic Compatibility Directive 2014/30/EU, RoHS Directive 2011/65/EU and following amendments.





GETTING STARTED

ACCESSORIES SELECTION GUIDE

Action	Setting	Food	Accessory
Chop	1 or Pulse	Cheese* Chocolate* Fruits Fresh herbs	Multipurpose Stainless Steel Blade
Mince or Purée	2 or Pulse	Nuts* Tofu Vegetables Beef***	
Mix	1	Pasta Sauce Pesto Salsa Sauces Batters	
Slice (thin to thick)	1	Fruit (soft) Potatoes Tomatoes Vegetables (soft)	Externally Adjustable Slicing Disc
	2	Cheese Fruit (hard) Vegetables (hard)	
Shred (fine to medium)	1	Potatoes Vegetables (soft)	Reversible Fine/Medium Shredding Disc
	2	Cabbage Cheese Chocolate Fruits (hard) Vegetables (hard)	
Dice	1	Potatoes Vegetables Fruit Cheese	Dicing Kit
Knead	1	Yeast** Dough**	Dough Blade

NOTE: Do not operate the appliance exceeding a maximum of 3 minutes. After 3 minutes the appliance needs to cool down to avoid overheating.

*For these ingredients it is not recommended to process quantities larger than 500g (¼ of work bowl) with the Multipurpose Stainless Steel Blade.

**For these ingredients it is not recommended to process quantities larger than 384g.

***Do not process more than 225g, chop beef into 1cm cubes prior to adding to bowl.





PRODUCT ASSEMBLY

Before first use

Before using your Food Processor for the first time, wash all parts and accessories either by hand or in the dishwasher (see "Care and Cleaning" section).

NOTE: Your Food Processor is designed so that all accessories may be stored inside the Work Bowl.

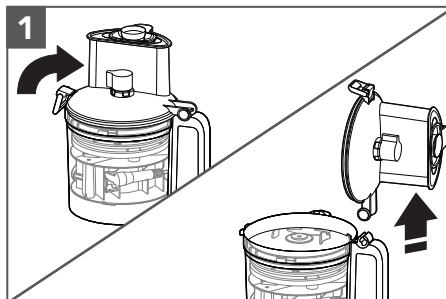

1 Lift up the Lid Latch to unlock the Cover. Tilt the Work Bowl Cover back and lift it straight up so that the Lid Hinge pulls out of the Handle Hinge.

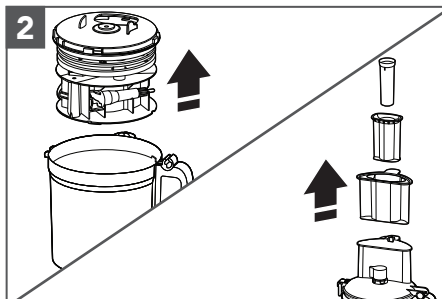

2 Remove all parts and accessories from the Work Bowl, and lift the Food Pusher out of the Feed Tube.

IMPORTANT: Place the Food Processor on a dry, level countertop with the controls facing forward. Do not plug in the Food Processor until it is completely assembled.

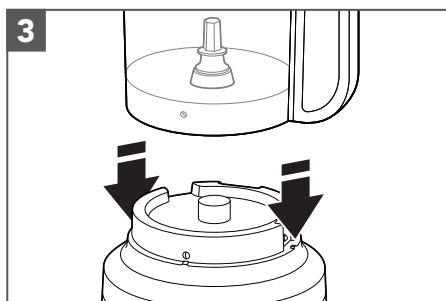

3 Place the Work Bowl on the Base, aligning the Handle with the raised button on the right side of the Base. The bowl will click into place and should be flush against the Base when properly aligned.

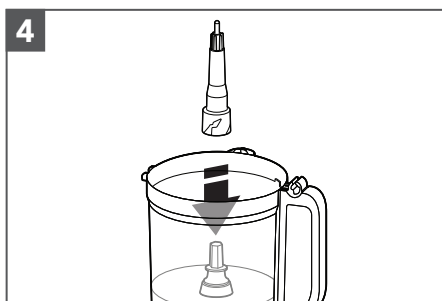

4 Place the Drive Adapter in the Work Bowl, lowering it onto the Drive Pin.





PRODUCT ASSEMBLY

NOTE: For ease of assembly, install the desired Blade or Disc before attaching the Work Bowl Cover.

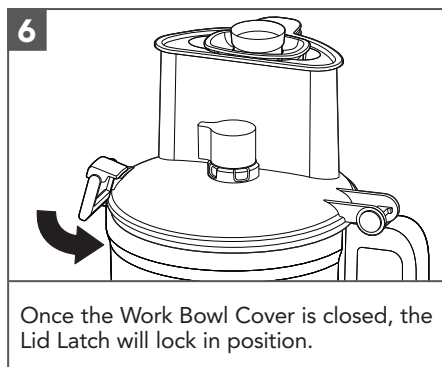
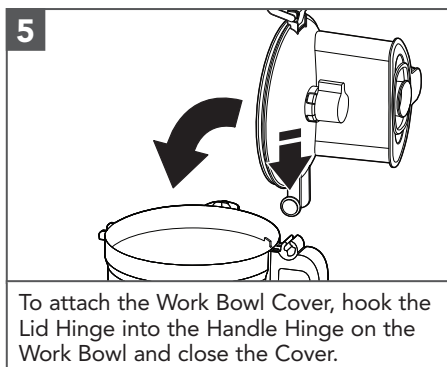

NOTE: Your Food Processor will not operate unless the Work Bowl Cover is fully closed, the large Food Pusher is in place, and the Work Bowl is properly seated on the Base.

INSTALLING THE MULTIPURPOSE BLADE OR DOUGH BLADE

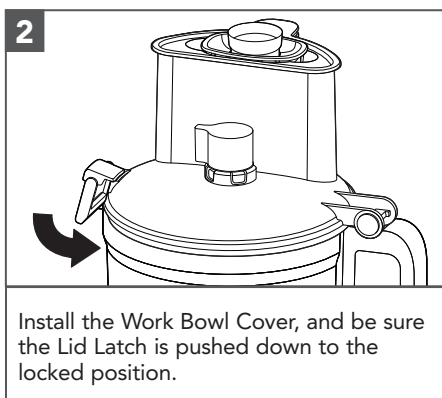
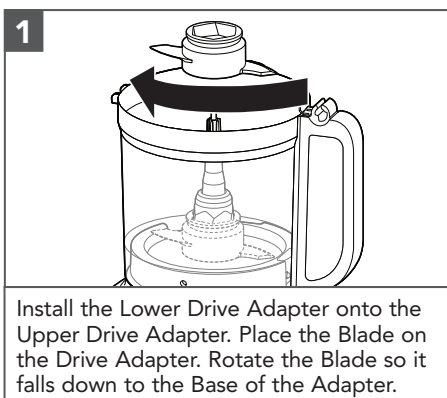



PRODUCT ASSEMBLY

INSTALLING THE EXTERNALLY ADJUSTABLE SLICING DISC

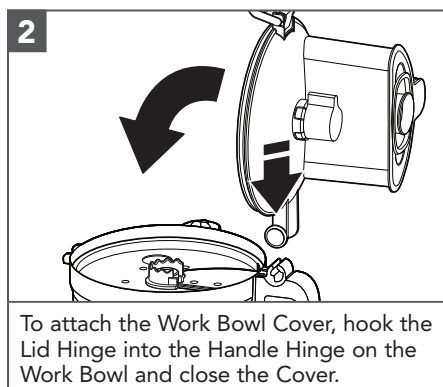
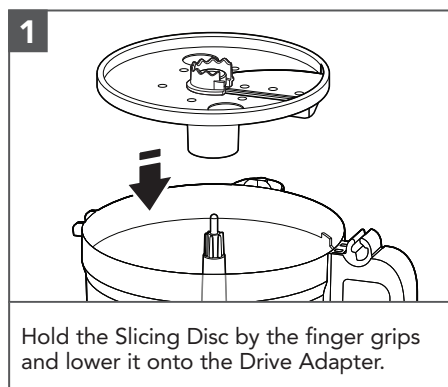

TIP: You may need to adjust the Drive Adapter with a slight turn on the power shaft until it drops into place. For easiest installation, make sure the Adjustment Knob is in the "0" position.

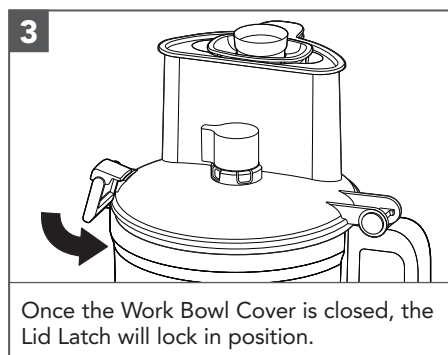

NOTE: Your Food Processor will not operate unless the Work Bowl Cover is fully closed and the Work Bowl is properly seated on the Base.

ADJUSTING THE SLICING THICKNESS

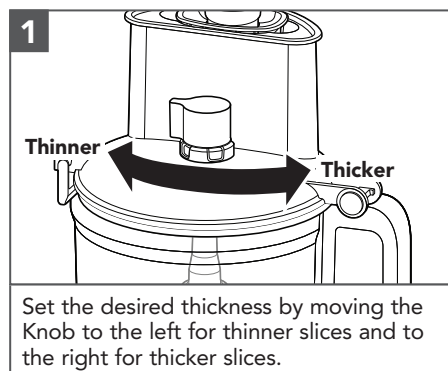

NOTE: The Knob only works with the Externally Adjustable Slicing Disc. Changing thickness settings with other discs or Blades installed will have no effect on operation.





PRODUCT ASSEMBLY

INSTALLING THE DICING KIT

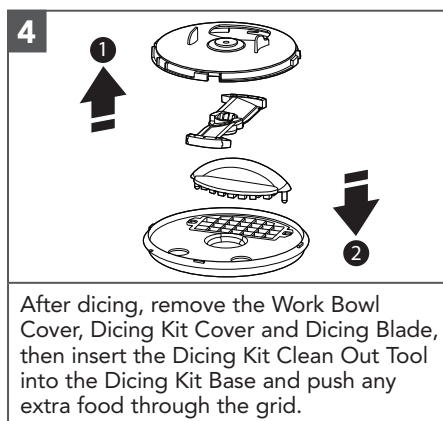
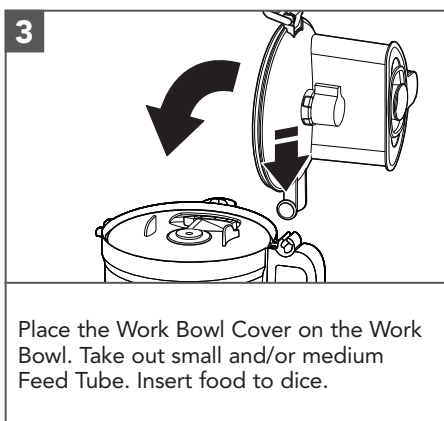
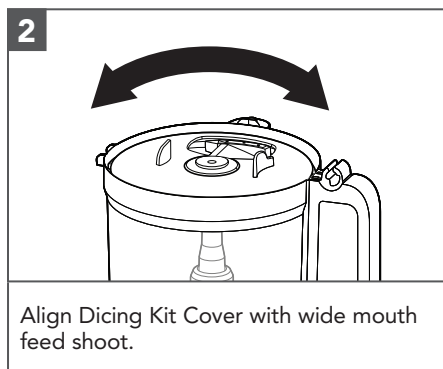
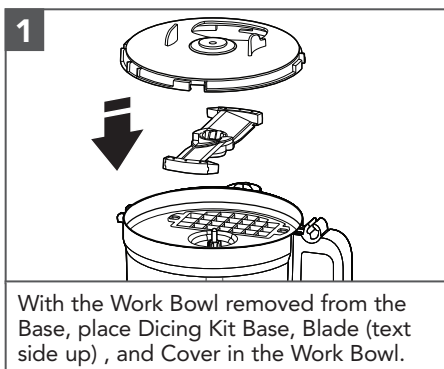

PRODUCT USAGE

⚠ WARNING



Rotating Blade Hazard

- Always use food pusher.
- Keep fingers out of openings.
- Keep away from children.
- Failure to do so can result in amputation or cuts.

Before operating the Food Processor, be sure the Work Bowl, Blades/Disc, and Work Bowl Cover are properly assembled on the Base (see the "Product Assembly" section).





PRODUCT USAGE

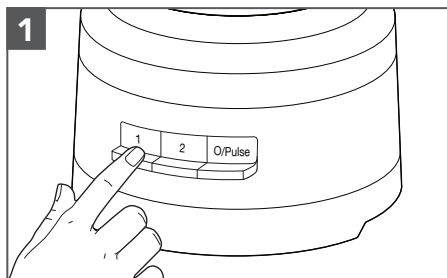

To turn on, press 1 or 2. The Food Processor will run continuously and the indicator light will glow.

To turn off, press 1 or 2 again, or press O/Pulse.

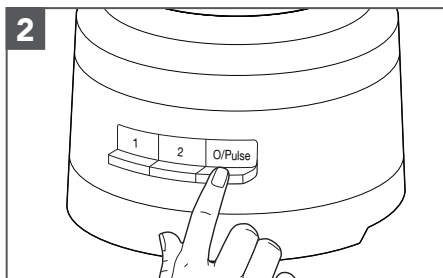

To use the Pulse function:

Press O/Pulse for short bursts, or press and hold for longer bursts. The Pulse function runs at speed 2 only. The Food Processor will turn off when the O/Pulse button is released.

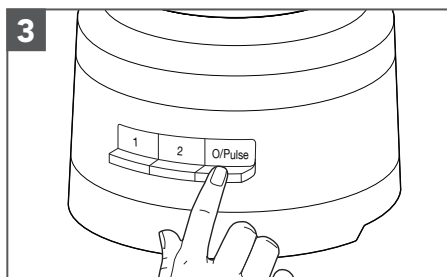

When finished, press the O/Pulse button. The indicator light will go out and the Blade or Disc will slow to a stop.

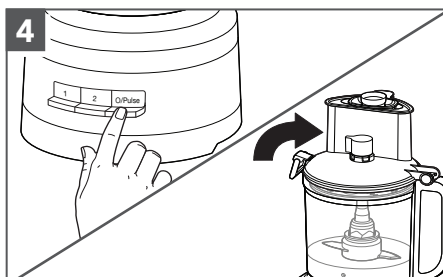

Wait until the Blade or disc comes to a complete stop before removing the Work Bowl Cover. Be sure to turn off the Food Processor before removing the Work Bowl Cover, or before unplugging the Food Processor.

USING THE 3-IN-1 FEED TUBE

The 3-in-1 Feed Tube features a 3-piece Food Pusher.

Use the entire Feed Tube and the large Food Pusher to process large items.

NOTE: The unit will not start if food is loaded in the large Feed Tube above the max fill line.

Use the medium Food Pusher in the Feed Tube to process smaller items.

Use the small Food Pusher to slice or shred the smallest, thinnest items.

Use the drizzle hole in the small Food Pusher to slowly drizzle oil or other liquid ingredients into the Work Bowl.



3-Piece Food Pusher





PRODUCT DISASSEMBLY

REMOVING PROCESSED FOODS

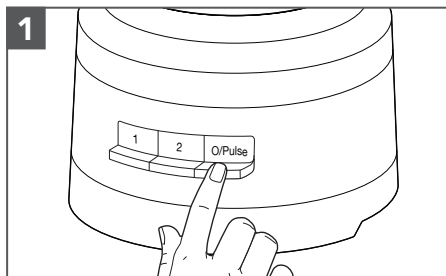

1 **Turn the Food Processor off:** Press the O/Pulse button and unplug the Food Processor before disassembling.

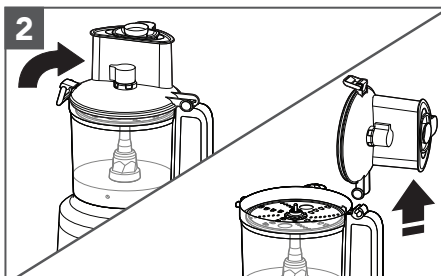

2 Lift the Lid Latch to unlock the Work Bowl Cover, then lift the Cover to remove.

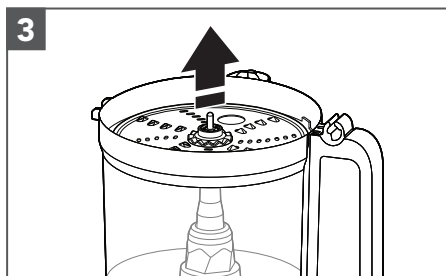

3 If using the disc, remove it before removing the bowl. Holding the disc by the finger holes, lift it straight up.

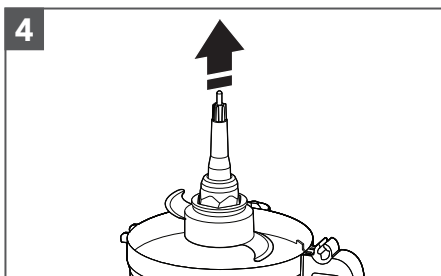

4 Remove the Drive Adapter and Multipurpose Blade, if using. The Blade will stay in place on the Drive Adapter when you remove the Adapter.

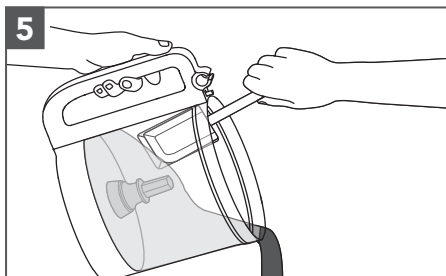

5 Lift the Work Bowl off of the Base to remove food from the bowl with a spatula.





CARE AND CLEANING

IMPORTANT: The BPA-free bowl requires special handling. If you choose to use a dishwasher instead of hand washing, please follow these guidelines.

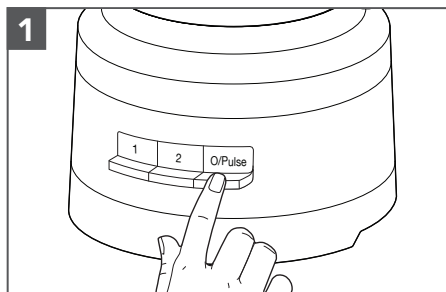

Press the O/Pulse button, then unplug the Food Processor before cleaning.

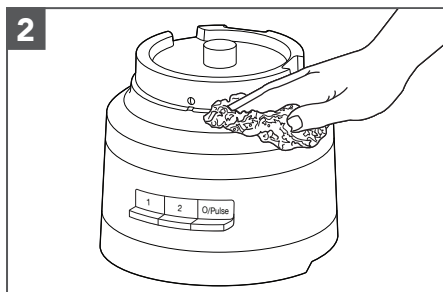

Wipe the Base and cord with a warm, damp cloth. Thoroughly dry with a soft cloth. Do not use abrasive cleaners or scouring pads. Do not immerse Base in water or other liquid.

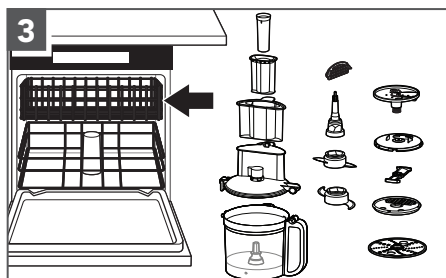

All parts are top rack dishwasher safe. Avoid laying the bowl on its side. Thoroughly dry all parts after washing. Use gentle dishwashing cycles such as normal. Avoid high-temperature cycles.

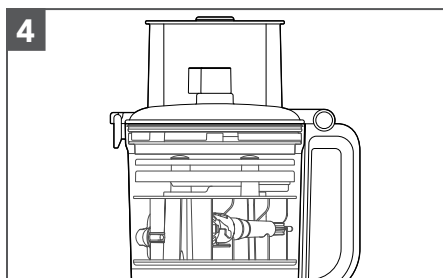

You can store up to two Blades and three discs as well as the Drive Adapter inside the Work Bowl by using the in bowl Storage Caddy when the Food Processor is not in use. Wrap the Power Cord around the Cord Storage on the bottom of the Base, then secure the plug by clipping it to the housing.

NOTE: If washing the Food Processor parts by hand, avoid the use of abrasive cleansers or scouring pads. They may scratch or cloud the Work Bowl and Cover.





TROUBLESHOOTING GUIDE

Problem	Solution
If your Food Processor should malfunction or fail to operate, check the following:	Check to see if the Food Processor is securely plugged into an earthed electrical outlet.
	Make sure that the Bowl and Lid are properly aligned and locked in place.
	Have you pressed more than one button at the same time?
	Unplug the Food Processor, then plug it back into the outlet.
Is the fuse in the circuit to the Food Processor in working order?	If you have a circuit breaker box, be sure the circuit is closed.
The Food Processor may need to cool to room temperature:	If the speed light turns off and the O/Pulse light flashes, wait until the O/Pulse light turns off and retry. The Food Processor may take from 5-15 minutes to cool completely.
The motor may be locked:	If the speed light stays on while the O/Pulse light flashes, press the O/Pulse button to reset the motor.
Food Processor not shredding or slicing properly:	Make sure the raised-Blade side of the disc is positioned face up on the Drive Adapter.
	Make sure ingredients are suitable for slicing or shredding.
	Make sure the disc is positioned in the process position (near the top of the bowl), and not the storage position (low and inside of the bowl).
If the Work Bowl Cover won't close when using the disc:	Make sure the disc is installed correctly, and is positioned properly on the Drive Adapter.
If the problem cannot be corrected:	See the "Terms of KitchenAid Guarantee("Guarantee")" sections. Do not return the Food Processor to the retailer. Retailers do not provide service.



TERMS OF KITCHENAID GUARANTEE ("GUARANTEE")

Covering U.K. - Ireland - South Africa - UAE

KitchenAid Europa, Inc., Nijverheidslaan 3, Box 5, 1853 Strombeek-Bever, Belgium ("Guarantor") grants the end-customer, who is a consumer, a Guarantee pursuant to the following terms.

FOR U.K.:

The Guarantee applies in addition to and does not limit or affect the statutory warranty rights of the end-customer against the seller of the product. In summary, the Consumer Rights Act 2015 says products must be as described, fit for purpose and of satisfactory quality. During the expected lifespan of your product your legal rights entitle you to the following:

- Up to 30 days: if your product is faulty, then you can get an immediate refund.
- Up to six months: if your product can't be repaired or replaced, then you're entitled to a full refund, in most cases.
- Up to six years: if your product does not last a reasonable length of time you may be entitled to some money back.

These rights are subject to certain exceptions. For detailed information please visit the Citizens Advice website www.adviceguide.org.uk or call **03454 04 05 06**.

FOR IRELAND:

The Guarantee applies in addition to and does not limit or affect the statutory warranty rights of the end-customer against the seller of the product under the European Communities (Certain Aspects of the Sale of Consumer Goods and Associated Guarantees Regulations 2003 (S.I. No. 11/2003)) and other enactments governing the sale of consumer goods.

FOR SOUTH AFRICA:

The Guarantee applies in addition to and does not limit or affect the statutory warranty rights of the end-customer against the seller of the product. In summary, the Consumer Protection Act, 2008 says that products must be: (i) reasonably suitable for the purpose for which they are intended; (ii) in good working order, of good quality and free of any defects; (iii) useable and durable for a reasonable period of time, having regard to the use to which they would normally be put and to all the surrounding circumstances; and (iv) in compliance with any applicable standards or any other public regulations.

During the expected lifespan of your product and where the products are not purchased online, your legal rights will entitle you to the following:

- You will be entitled to a full refund, if you did not have the opportunity to examine the product before delivery and if you rejected delivery of the product on the basis that the type and quality of the product was not as reasonably expected or did not reasonably conform to the material specifications.
- Within 5 business days after delivery: you may rescind your purchase and request a refund, if your purchase resulted from direct marketing.
- Within 10 business days after delivery: you will be entitled to a full refund, if it is found that the product was unsuitable for a particular purpose specifically communicated to you by the Guarantor.
- Within 15 business days after delivery: you will be entitled to a refund if: (i) the product was not delivered to you; or (ii) if you returned the product to the Guarantor.
- Within 6 months after delivery: you will be entitled to a refund or a replacement product, if the product is defective or fails to operate in terms of its specifications.





TERMS OF KITCHENAID GUARANTEE ("GUARANTEE")

Where you have purchased a product online your legal rights will be governed by the Electronic Communications and Transactions Act, 2002 and you will be entitled to the following:

- Within 7 days after conclusion of the transaction or after delivery: you may cancel your purchase without reason and without penalty.
- Within 30 days of the date of cancellation of the transaction: you will be entitled to receive a refund, if you have already made payment.
- You will only be liable for the direct costs of returning the product to the Guarantor.

FOR UAE:

The Guarantee applies in addition to and does not limit or affect the statutory warranty rights of the end-customer against the seller of the product.

1) SCOPE AND TERMS OF THE GUARANTEE

a) The Guarantor grants the Guarantee for the products mentioned under Section 1.b) which a consumer has purchased from a seller or a company of the KitchenAid-Group within the following countries: U.K., Ireland, or South Africa, or the United Arab Emirates (UAE).

b) The Guarantee period depends on the purchased product and is as follows:

5KFP1318*, 5KFP1319* Two years full guarantee from date of purchase.

c) The Guarantee period commences on the date of purchase, i.e. the date on which a consumer purchased the product from a dealer or a company of the KitchenAid-Group.

d) The Guarantee covers the defect-free nature of the product.

e) The Guarantor shall provide the consumer with the following services under this Guarantee, at the choice of the Guarantor, if a defect occurs during the Guarantee period:

- Repair of the defective product or product part, or
- Replacement of the defective product or product part. If a product is no longer available, the Guarantor is entitled to exchange the product for a product of equal or higher value.

f) If the consumer wishes to make a claim under the Guarantee, the consumer has to contact the country specific KitchenAid service centres or the Guarantor directly at KitchenAid Europa, Inc. Nijverheidslaan 3, Box 5, 1853 Strombeek-Bever, Belgium;

Email-Address U.K.: CONSUMERCARE.UK@kitchenaid.eu

Email-Address IRELAND: CONSUMERCARE.IE@kitchenaid.eu

Toll Free Number U.K. & IRELAND: **00 800 381 040 26**

FOR SOUTH-AFRICA:

Our local KitchenAid Distributor:

KitchenAid Africa
PO Box 52102
V&A Waterfront
Cape Town
8002



TERMS OF KITCHENAID GUARANTEE ("GUARANTEE")

Contact our distributor:

Telephone: +27 21 555 0700

You can contact our Customer Service Centre for Small Domestic Appliances from 8.30 am to 1.00pm and from 1.30 pm to 5.00 pm or write to us at the following address: hello@kitchenaidafrica.com

FOR UAE:

AL GHANDI ELECTRONICS.

POST BOX NO. 9098,

DUBAI, UNITED ARAB EMIRATES

Toll free number: +971 4 2570007

g) The costs of repair, including spare parts, and any postage costs (if applicable) for the delivery of a defect-free product or product part shall be borne by the Guarantor. The Guarantor shall also bear the postage costs for returning the defective product or product part if the Guarantor or the country specific KitchenAid customer service centre requested the return of the defective product or product part. However, the consumer shall bear the costs of appropriate packaging for the return of the defective product or product part.

h) To be able to make a claim under the Guarantee, the consumer must present the receipt or invoice of the purchase of the product.

2) LIMITATIONS OF THE GUARANTEE

a) **The Guarantee applies only to products used for private purposes and not for professional or commercial purposes.**

b) **The Guarantee does not apply in the case of normal wear and tear, improper or abusive use, failure to follow the instructions for use, use of the product at the wrong electrical voltage, installation and operation in violation of the applicable electrical regulations, and use of force (e.g. blows).**

c) **The Guarantee does not apply if the product has been modified or converted, e.g. conversions from 120 V products to 220-240 V products.**

d) **The provision of Guarantee services does not extend the Guarantee period, nor does it initiate the commencement of a new Guarantee period. The Guarantee period for installed spare parts ends with the Guarantee period for the entire product.**

e) **FOR SOUTH-AFRICA & UAE ONLY:**

Further or other claims, in particular claims for damages, are excluded unless liability is mandatory by law.

After expiry of the Guarantee period or for products for which the Guarantee does not apply, the KitchenAid customer service centres are still available to the end-customer for questions and information.

Further information is also available on our website:

- For U.K. & Ireland www.kitchenaid.eu

- For South-Africa: www.kitchenaidafrica.com

- For UAE: www.KitchenAid-MEA.com

PRODUCT REGISTRATION

Register your new KitchenAid appliance now: <http://www.kitchenaid.eu/register>

©2021 All rights reserved.

