



5KEK1565



KitchenAid







English	5
Deutsch	15
Français	25
Italiano	35
Nederlands	45
Español	55
Português	65
Ελληνικά	75
Svenska	85
Norsk	95
Suomi	105
Dansk	115
Íslenska	125
Русский	135
Polski	145
Český	155
Türkçe	165
العربية	175







TABLE OF CONTENTS

PARTS AND FEATURES 6
 Parts and accessories.....6

ELECTRIC KETTLE SAFETY 7
 Important safeguards7
 Electrical requirements 11
 Electrical equipment waste disposal 11

USING THE ELECTRIC KETTLE 12
 Operating the Electric Kettle 12

CARE AND CLEANING 13
 Cleaning the Electric Kettle 13
 Descaling the Electric kettle 13

WARRANTY AND SERVICE 14





PARTS AND FEATURES

PARTS AND ACCESSORIES

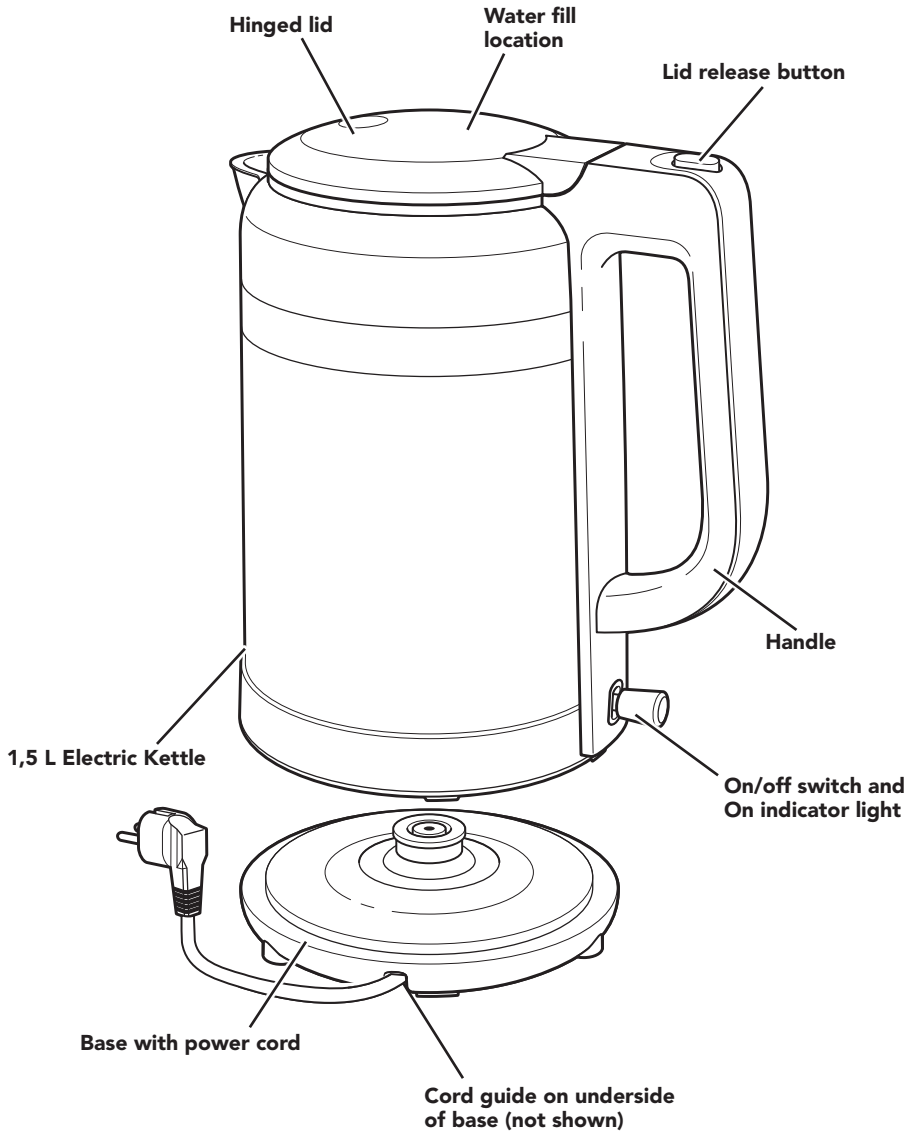



ELECTRIC KETTLE SAFETY

Your safety and the safety of others are very important.

We have provided many important safety messages in this manual and on your appliance. Always read and obey all safety messages.



This is the safety alert symbol.

This symbol alerts you to potential hazards that can kill or hurt you and others.

All safety messages will follow the safety alert symbol and either the word "DANGER" or "WARNING." These words mean:



You can be killed or seriously injured if you don't immediately follow instructions.



You can be killed or seriously injured if you don't follow instructions.

All safety messages will tell you what the potential hazard is, tell you how to reduce the chance of injury, and tell you what can happen if the instructions are not followed.

IMPORTANT SAFEGUARDS

When using electrical appliances, basic safety precautions should always be followed, including the following:

1. Read all instructions. Misuse of appliance may result in personal injury.
2. Do not touch hot surfaces. Use handles or knobs.
3. The appliance must not be immersed. To protect against electrical shock do not immerse cord, plugs or appliance in water or other liquid. Avoid spillage on the connector.
4. This appliance is not intended for use by persons (including children) with reduced physical, sensory or mental capabilities, or lack of experience and knowledge, unless they have been given supervision or instruction concerning use of the appliance by a person responsible for their safety.



ELECTRIC KETTLE SAFETY

5. This appliance can be used by children aged from 8 years and above and persons with reduced physical, sensory or mental capabilities or lack of experience and knowledge if they have been given supervision or instruction concerning use of the appliance in a safe way and understand the hazards involved. Children shall not play with the appliance. Cleaning and user maintenance shall not be made by children without supervision.
6. If the supply cord is damaged, it must be replaced by the manufacturer, its service agent or similarly qualified persons in order to avoid a hazard.
7. Keep the appliance and its cord out of reach of children less than 8 years.
8. European Union only: Appliances can be used by persons with reduced physical, sensory or mental capabilities or lack of experience and knowledge if they have been given supervision or instruction concerning use of the appliance in a safe way and understand the hazards involved. Children shall not play with the appliance.
9. European Union only: This appliance shall not be used by children. Keep the appliance and its cord out of reach of children.
10. Unplug Electric Kettle from outlet when not in use and before cleaning. Allow to cool before putting on or taking off parts, and before cleaning the appliance.
11. Do not operate any appliance with a damaged cord or plug or after the appliance malfunctions, or has been damaged in any manner. Return appliance to the nearest Authorised Service Centre for examination, repair, or adjustment.





ELECTRIC KETTLE SAFETY

12. The use of accessory attachments not recommended by the appliance manufacturer may result in fire, electric shock or injury to persons.
13. Do not use outdoors.
14. Do not let cord hang over edge of table or counter, or touch hot surfaces.
15. To disconnect, turn any control to “OFF”, then remove plug from wall outlet.
16. Children should be supervised to ensure that they do not play with the appliance.
17. Close supervision is necessary when any appliance is used by or near children.
18. The heating element surface is subject to residual heat after use. Do not touch hot surface. Use handles.
19. Do not place on or near a hot gas or electric burner, or in a heated oven.
20. The Electric Kettle should only be used to heat water.
21. Do not use Electric Kettle with loose or weakened handle.
22. Do not use the appliance for other than intended use.
23. Do not clean Electric Kettle with abrasive cleaners, steel wool, or other abrasive materials.
24. The Electric Kettle is only to be used with the stand provided.
25. Do not overfill kettle. If the kettle is overfilled, boiling water may be ejected.
26. Scalding may occur if the lid is removed during the brewing cycles.



ELECTRIC KETTLE SAFETY

27. Refer to the “Care and Cleaning” section for instructions on cleaning the surfaces in contact with food.
28. This appliance is intended to be used in household and similar applications such as:
 - staff kitchen areas in shops, offices or other working environments;
 - farmhouses;
 - by clients in hotels, motels and other residential type environments;
 - bed and breakfast type environments.
29. **WARNING:** To prevent electric shock, unplug before servicing.
30. This Instruction manual can also be found on the www.KitchenAid.eu website.
31. Appliances are not intended to be operated by means of an external timer or separate remote-control system.
32. The temperature of accessible surfaces may be high when the appliance is operating.

SAVE THESE INSTRUCTIONS



ELECTRIC KETTLE SAFETY

ELECTRICAL REQUIREMENTS

⚠ WARNING



Electrical Shock Hazard

Plug into an earthed outlet.

Do not remove earth prong.

Do not use an adapter.

Do not use an extension cord.

Failure to follow these instructions can result in death, fire, or electrical shock.

Volts: 220-240 V

Hertz: 50-60 Hz

Wattage: 2520-3000 W for UK version
2000-2400 W for EU version

NOTE: If the plug does not fit in the outlet, contact a qualified electrician. Do not modify the plug in any way.

Do not use an extension cord. If the power supply cord is too short, have a qualified electrician or service technician install an outlet near the appliance.

A short power supply cord (or detachable power supply cord) should be used to reduce the risk resulting from becoming entangled in or tripped over a longer cord.

ELECTRICAL EQUIPMENT WASTE DISPOSAL

Disposal of packing material

The packing material is 100% recyclable and is marked with the recycle symbol . The various parts of the packing must therefore be disposed of responsibly and in full compliance with local authority regulations governing waste disposal.

Scrapping the product

- This appliance is marked in compliance with European Directive 2012/19/EU, Waste Electrical and Electronic Equipment (WEEE).

- By ensuring this product is disposed of correctly, you will help prevent potential negative consequences for the environment and human health, which could otherwise be caused by inappropriate waste handling of this product.



- The symbol  on the product or on the accompanying documentation indicates that it should not be treated as domestic waste but must be taken to an appropriate collection centre for the recycling of electrical and electronic equipment.

For more detailed information about treatment, recovery, and recycling of this product, please contact your local city office, your household waste disposal service, or the shop where you purchased the product.





USING THE ELECTRIC KETTLE

OPERATING THE ELECTRIC KETTLE

Before using your Electric Kettle for the first time, wash the Kettle and lid in hot, soapy water, then rinse with clean water and dry. Fill the Electric Kettle with water to the MAX fill line; boil the water and then discard. To avoid damage, do not fully immerse the Electric Kettle in water, and do not use abrasive cleaners or scouring pads.

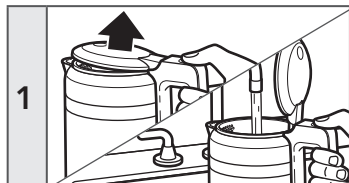

1 Open the lid of the Electric Kettle by pressing the lid release button, then fill the Electric Kettle with clean, cold water

NOTE: Water must be at or above the MIN fill line for the Electric Kettle to operate. Do not exceed the MAX fill line.



2 Push the lid down so that it is completely closed.

⚠ WARNING

Electrical Shock Hazard



Plug into an earthed outlet.

Do not remove an earth prong.

Do not use an adapter.

Do not use an extension cord.

Failure to follow these instructions can result in death, fire, or electrical shock.

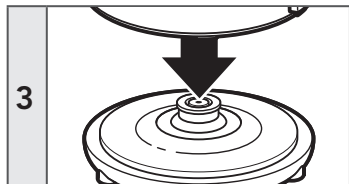

3 Place the Electric Kettle on the base, and plug the power cord into an earthed outlet.

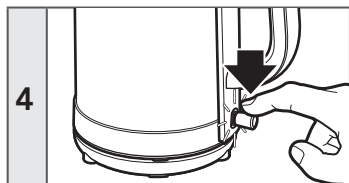

4 Flip the on/off switch down; the On indicator will light and the Electric Kettle will begin heating the water.





USING THE ELECTRIC KETTLE

5		Once the water reaches boiling, the Electric Kettle will turn off automatically; the on/off switch will flip up, and the indicator light will dim to indicate that heating is complete.
----------	---	---

IMPORTANT: Be sure to unplug the cord when the Electric Kettle is not in use.

FOR DETAILED INFORMATION ON USING THE ELECTRIC KETTLE

Visit kitchenaid.com/quickstart for additional instructions with videos, inspiring recipes, and tips on how to use your Electric Kettle.

CARE AND CLEANING

CLEANING THE ELECTRIC KETTLE

IMPORTANT: Before cleaning, always disconnect the Electric Kettle from the electrical outlet. Make sure the Electric Kettle has cooled completely.

1		The exterior of the Electric Kettle may be cleaned with a damp cloth. Dry and polish the Electric Kettle with a soft cloth. Abrasives and scouring agents of any kind are not recommended.
----------	---	--

DESCALING THE ELECTRIC KETTLE

To get the best performance from your Electric Kettle, decalcification will be necessary. Calcium deposits may form on the interior metal parts of the Electric Kettle. The cleaning interval will depend on the hardness of the water you put in the Electric Kettle.

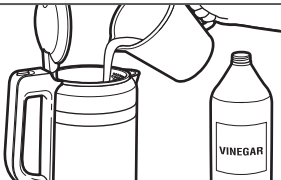
1		Fill the Electric Kettle with 1 cup (0,25 L) white vinegar. Add 3 cups (0,75 L) water. Boil and allow to stand overnight before emptying the solution.
----------	---	--

2		Fill the Electric Kettle with water, bring to a boil, and drain out the water. Repeat this step twice. The Electric Kettle is now ready to use.
----------	---	---

FOR DETAILED INFORMATION ON CLEANING THE ELECTRIC KETTLE

Visit kitchenaid.com/quickstart for additional instructions with videos, inspiring recipes, and tips on how to clean your Electric Kettle.





WARRANTY AND SERVICE

KITCHENAID ELECTRIC KETTLE WARRANTY

Length of Warranty:	KitchenAid Will Pay For:	KitchenAid Will Not Pay For:
<p>Europe, Middle East and Africa: For Artisan models 5KEK1565: two years full warranty from date of purchase.</p>	<p>The replacement parts and repair labour costs to correct defects in materials or workmanship. Service must be provided by an Authorised KitchenAid Service Centre.</p>	<p>A. Repairs when Kettle is used for operations other than normal household food preparation. B. Damage resulting from accident, alterations, misuse, abuse, or installation/operation not in accordance with local electrical codes.</p>

KITCHENAID DOES NOT ASSUME ANY RESPONSIBILITY FOR INDIRECT DAMAGES.

CUSTOMER SERVICE

In U.K. and Ireland:

For any questions, or to find the nearest Authorised KitchenAid Service Centre, please find our contact details below.

NOTE: All service should be handled locally by an Authorised KitchenAid Service Centre.

General hotline number:  00800 3810 4026

In other countries:

For all product related questions and after sales matters, please contact your dealer to obtain the name of the nearest Authorised KitchenAid Service/Customer Centre.

For more information, visit our website at:

**www.KitchenAid.co.uk
www.KitchenAid.eu**

©2018 All rights reserved. Specifications subject to change without notice.

