

DR | DRAGON™

CEILING FAN HEATER



THE AUTHENTIC DRAGON!

The hallmark of the Dragon is that it recycles residual warm air that has accumulated at the ceiling, mixing it with the cooler air below. The result? Uniform air temperature and energy savings. The Dragon offers an output of 2000 W to 10 000 W, depending on the model, and offers voltages ranging from 208 V to 600 V. This unit can be ceiling surface mounted or ceiling recessed, suspended at a minimum of 8 feet from the floor. The Dragon is well suited for building entryways, stairwells, warehouses, garages, workshops and hallways. Nothing beats the power of the Dragon!

FAST TEMPERATURE RISE VIA HEAT RECOVERY

CHOICE OF 2000 W TO 10 000 W

STATE-OF-THE ART EFFICIENCY NICHROME ELEMENT

SURFACE MOUNTED OR RECESSED INSTALLATION

OPTIONAL OFS MODEL TO CONTROL FAN-ONLY MODE WITH WALL SWITCH

IDEAL FOR:

building entryway, warehouse, stairwell, garage, workshop

COLOURS

- **standard:** white, soft white
- **Orora (optional):** refer to www.stelpro.com/en-CA/Orora

FINISH

- epoxy-polyester powdercoat

MANUFACTURING

- 20-gauge steel cabinet and 14-gauge steel grille
- quiet helicoidal fan
- thermal protection with automatic reset
- totally enclosed, permanently lubricated motor

ELEMENT

- nichrome element produces instant heat

CONTROL

- wall thermostat (not included) – the use of an electronic thermostat is strongly recommended (up to 4000 W)
- fan-only mode for continuous air circulation, controlled by built-in selection switch

- fan-only mode available for use with wall mounted switch (optional OFS model, wall switch not provided)
- heating mode, confirmed by pilot light when heating is on
- connection of multiple units to the same thermostat is possible with a relay kit without a transformer (optional) and an external transformer (not provided)

INSTALLATION

- ceiling recessed in a T-bar (DRR model)
- ceiling surface mounted with bracket to support unit during wiring (DRI and DRII models) (included)
- install at a minimum distance from adjacent or surrounding walls: 12 in. (DRR or DRI models); 24 in. (DRII models)
- mounting heights: 8 ft. (2 kW or 3 kW units); 10 ft. (4 kW or 5 kW units); 12 ft. (7.5 kW or 10 kW units)
- 2 to 6 wires required for connections according to the selected control (see the connections table in the installation guide)

WARRANTY

- three years

°STELPRO

Stelpro reserves the right to modify descriptions, manufacturing specifications or prices without prior notice. No returns accepted on optional-colour products. For all the latest models and prices, please refer to our website at www.stelpro.com.



TECHNICAL SPECIFICATIONS

DRI AND DRII MODELS (SURFACE MOUNTED INSTALLATION)

WITHOUT CONTROL	BUILT-IN THERMOSTAT	240 V CONTROL	24 V CONTROL	POWER	VOLTAGE	FLOW	WEIGHT	
CODE	CODE	CODE	CODE	WATTS	VOLTS	CFM	KG	LB
DRI0281	DRI0281T	---	DRI0281C24	2000	208	250	7.2	16
DRI0221	DRI0221T	---	DRI0221C24	2000	240	250	7.2	16
DRI0381	DRI0381T	---	DRI0381C24	3000	208	250	7.2	16
DRI0321	DRI0321T	---	DRI0321C24	3000	240	250	7.2	16
DRI0481	DRI0481T	---	DRI0481C24	4000	208	450	7.2	16
DRI0421	DRI0421T	---	DRI0421C24	4000	240	450	7.2	16
---	DRI0581T	---	DRI0581C24	5000	208	450	7.2	16
DRI0521	DRI0521T	---	DRI0521C24	5000	240	450	7.2	16
---	DRII0281T	DRII0281C	DRII0281C24	2000	208	450	20.4	45
---	DRII0283CT*	DRII0283C*	DRII0283C24*	2000	208	450	20.4	45
---	DRII0221T	DRII0221C	DRII0221C24	2000	240	450	20.4	45
---	DRII0231CT	DRII0231C	DRII0231C24	2000	347	450	20.4	45
---	DRII0261CT	DRII0261C	DRII0261C24	2000	600	450	20.4	45
---	DRII0263CT*	DRII0263C*	DRII0263C24*	2000	600	450	20.4	45
---	DRII0381T	DRII0381C	DRII0381C24	3000	208	450	20.4	45
---	DRII0383CT*	DRII0383C*	DRII0383C24*	3000	208	450	20.4	45
---	DRII0321T	DRII0321C	DRII0321C24	3000	240	450	20.4	45
---	DRII0331CT	DRII0331C	DRII0331C24	3000	347	450	20.4	45
---	DRII0361CT	DRII0361C	DRII0361C24	3000	600	450	20.4	45
---	DRII0363CT*	DRII0363C*	DRII0363C24*	3000	600	450	20.4	45
---	DRII0481T	DRII0481C	DRII0481C24	4000	208	450	20.4	45
---	DRII0483CT*	DRII0483C*	DRII0483C24*	4000	208	450	20.4	45
---	DRII0421T	DRII0421C	DRII0421C24	4000	240	450	20.4	45
---	DRII0431CT	DRII0431C	DRII0431C24	4000	347	450	20.4	45
---	DRII0461CT	DRII0461C	DRII0461C24	4000	600	450	20.4	45
---	DRII0463CT*	DRII0463C*	DRII0463C24*	4000	600	450	20.4	45
---	DRII0581T	DRII0581C	DRII0581C24	5000	208	450	20.4	45
---	DRII0583CT*	DRII0583C*	DRII0583C24*	5000	208	450	20.4	45
---	DRII0521T	DRII0521C	DRII0521C24	5000	240	450	20.4	45
---	DRII0531CT	DRII0531C	DRII0531C24	5000	347	450	20.4	45
---	DRII0561CT	DRII0561C	DRII0561C24	5000	600	450	20.4	45
---	DRII0563CT*	DRII0563C*	DRII0563C24*	5000	600	450	20.4	45
---	DRII0781CT	DRII0781C	DRII0781C24	7500	208	700	20.4	45
---	DRII0783CT*	DRII0783C*	DRII0783C24*	7500	208	700	20.4	45
---	DRII0721CT	DRII0721C	DRII0721C24	7500	240	700	20.4	45
---	DRII0731CT	DRII0731C	DRII0731C24	7500	347	700	20.4	45
---	DRII0761CT	DRII0761C	DRII0761C24	7500	600	700	20.4	45
---	DRII0763CT*	DRII0763C*	DRII0763C24*	7500	600	700	20.4	45
---	DRII1081CT	DRII1081C	DRII1081C24	10 000	208	700	20.4	45
---	DRII1083CT*	DRII1083C*	DRII1083C24*	10 000	208	700	20.4	45
---	DRII1021CT	DRII1021C	DRII1021C24	10 000	240	700	20.4	45
---	DRII1031CT	DRII1031C	DRII1031C24	10 000	347	700	20.4	45
---	DRII1061CT	DRII1061C	DRII1061C24	10 000	600	700	20.4	45
---	DRII1063CT*	DRII1063C*	DRII1063C24*	10 000	600	700	20.4	45

Add W for white or SW for soft white (consult the optional colours chart or contact your Stelpro representative for all other colours).

Add OFS to control fan-only mode with a wall switch (not provided).

*Three-phase unit

Models also available in 277 V and 480 V.

--- not available

TECHNICAL SPECIFICATIONS

DRR MODELS (RECESSED INSTALLATION)

WITHOUT CONTROL	BUILT-IN THERMOSTAT	240 V CONTROL	24 V CONTROL	POWER	VOLTAGE	FLOW	WEIGHT	
CODE	CODE	CODE	CODE	WATTS	VOLTS	CFM	KG	LB
DRR0281	DRR0281T	DRR0281C	DRR0281C24	2000	208	250	13.6	30
---	DRR0283CT*	DRR0283C*	DRR0283C24*	2000	208	250	13.6	30
DRR0221	DRR0221T	DRR0221C	DRR0221C24	2000	240	250	13.6	30
---	DRR0231CT	DRR0231C	DRR0231C24	2000	347	250	13.6	30
---	DRR0261CT	DRR0261C	DRR0261C24	2000	600	250	13.6	30
---	DRR0263CT*	DRR0263C*	DRR0263C24*	2000	600	250	13.6	30
DRR0381	DRR0381T	DRR0381C	DRR0381C24	3000	208	250	14.7	32.5
---	DRR0383CT*	DRR0383C*	DRR0383C24*	3000	208	250	14.7	32.5
DRR0321	DRR0321T	DRR0321C	DRR0321C24	3000	240	250	14.7	32.5
---	DRR0331CT	DRR0331C	DRR0331C24	3000	347	250	14.7	32.5
---	DRR0361CT	DRR0361C	DRR0361C24	3000	600	250	14.7	32.5
---	DRR0363CT*	DRR0363C*	DRR0363C24*	3000	600	250	14.7	32.5
DRR0481	DRR0481T	DRR0481C	DRR0481C24	4000	208	450	14.7	32.5
---	DRR0483CT*	DRR0483C*	DRR0483C24*	4000	208	450	14.7	32.5
DRR0421	DRR0421T	DRR0421C	DRR0421C24	4000	240	450	14.7	32.5
---	DRR0431CT	DRR0431C	DRR0431C24	4000	347	450	14.7	32.5
---	DRR0461CT	DRR0461C	DRR0461C24	4000	600	450	14.7	32.5
---	DRR0463CT*	DRR0463C*	DRR0463C24*	4000	600	450	14.7	32.5
---	DRR0581T	DRR0581C	DRR0581C24	5000	208	450	15.4	34
---	DRR0583CT*	DRR0583C*	DRR0583C24*	5000	208	450	15.4	34
DRR0521	DRR0521T	DRR0521C	DRR0521C24	5000	240	450	15.4	34
---	DRR0531CT	DRR0531C	DRR0531C24	5000	347	450	15.4	34
---	DRR0561CT	DRR0561C	DRR0561C24	5000	600	450	15.4	34
---	DRR0563CT*	DRR0563C*	DRR0563C24*	5000	600	450	15.4	34

Add W for white or SW for soft white (consult the optional colours chart or contact your Stelpro representative for all other colours).

Add OFS to control fan-only mode with a wall switch (not provided).

*Three-phase unit

Models also available in 277 V and 480 V.

--- not available



DRR MODEL (RECESSED)

A REVOLUTIONARY METHOD OF HEATING, THAT ELIMINATES THE NEED FOR A TRADITIONAL CEILING FAN. The Dragon recuperates the warm air that would otherwise accumulate at the ceiling and recirculates it throughout the room.



DRI MODEL (SURFACE MOUNTED)

(PREVIOUS PAGE)

A UNIQUE SOURCE OF HEAT THAT OFFERS PERFORMANCE, STYLE, COMFORT AND ECONOMY! Ideal for garages, commercial entrances, factories and warehouses

TECHNICAL DRAWINGS

DRI MODEL

surface mounted

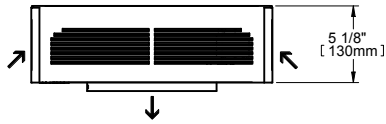

FRONT

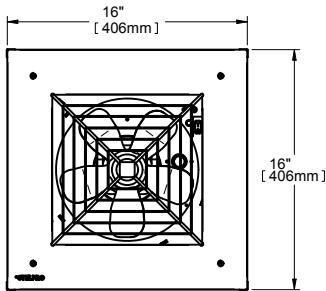

TOP

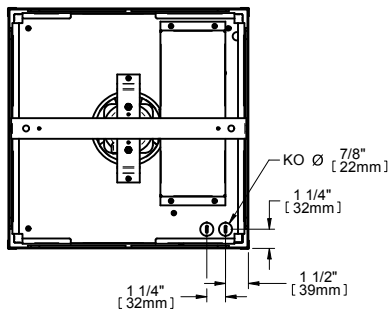

BOTTOM

DRII MODEL

surface mounted

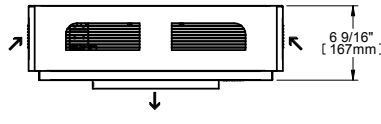

FRONT

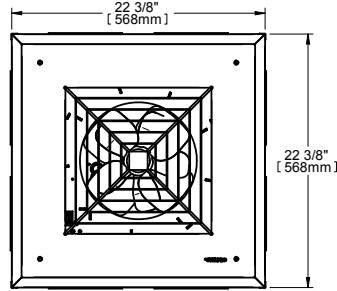

TOP

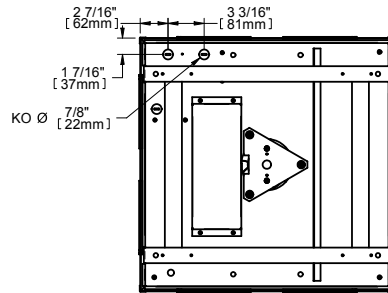

BOTTOM

DRR MODEL

recessed

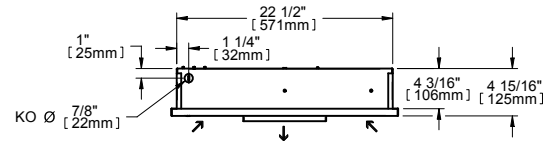

FRONT

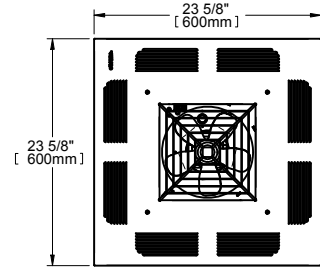

TOP

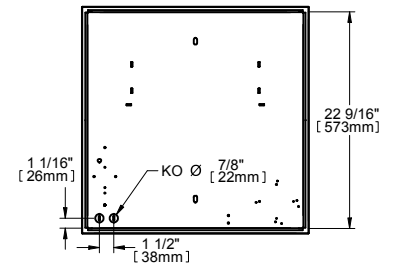

BOTTOM

THROW DISTANCE AND HEAT RISE

MODEL	UNITS	THROW DISTANCE		HEAT RISE	
		M	FT	°C	°F
DRI	2	7	23	14	25
	3	7	23	21	38
	4	7	23	16	28
	5	7	23	20	35
	DRII	2	7	23	8
DRII	3	7	23	12	21
	4	7	23	16	28
	5	7	23	20	35
	7.5	9.1	30	19	34
	10	9.1	30	25	45
DRR	2	7	23	14	25
	3	7	23	21	38
	4	7	23	16	28
DRR	5	7	23	20	35

ACCESSORIES

PRODUCT	DESCRIPTION
DRT1	built-in tamper-proof single pole thermostat (DRR, DRI or DRII models)
DRITBA1*	T-bar adapter (DRI models)
DRIITBA1*	T-bar adapter (DRII models)
DRC24RX*	relay kit without transformer 24 V (DRII or DRR models)
DRIC24RX*	relay kit without transformer 24 V (DRI models)

* Add W for white or SW for soft white.
* Factory installed