

Diva LED+ Dimmer

Dimmer for dimmable LED, CFL, halogen, and incandescent bulbs. **Features**

- Large paddle switch with a captive linear-slide dimmer for a standard designer wallplate opening.
- LED+ includes the most advanced technology for superior dimming of LED, CFL, incandescent, and halogen bulbs.
- ULR Listed to control:
 - Dimmable LEDs
 - Dimmable compact fluorescent lamps (CFL) with integrated ballast
 - Lutron LTEA Hi-lume 1% forward-phase LED driver
 - Halogen
 - Incandescent
- Low-end adjustment to accommodate a wide range of bulbs.
- 100% factory tested.
- Formerly C•L.
- Coordinating Claro and Stainless Steel wallplates available separately.

Application Requirements

- **When dimming LEDs or CFLs, only bulbs marked or rated as DIMMABLE may be used.**

- For a complete list of compatible DIMMABLE LEDs

please visit www.lutron.com/LEDfinder

- Some DIMMABLE LEDs and CFLs require a minimum number of bulbs for proper operation. For details and a list of bulbs, please visit www.lutron.com/LEDfinder

Model Numbers

DVCL-153P-XX ^{3,2} Gloss Finish, Single pole / 3-way⁴

DVCL-153PH-XXC⁵ Gloss Finish, Single pole / 3-way³ DVSCCL-

153P-XX ¹ Satin Finish, Single pole / 3-way³

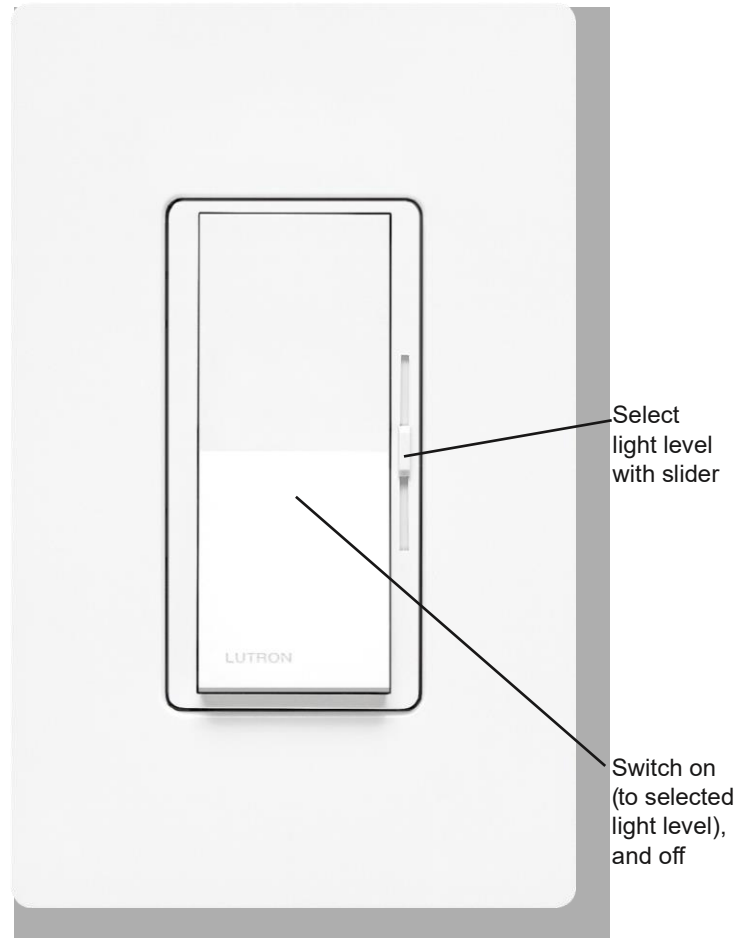

Packages

DVWCL-153PH-XX^{1,1}

DVWCL-153PH-XXC²

Includes

1 DVCL-153P-XX and 1 CW-1-XX (single-gang faceplate)

1 DVCL-153P-XX-C and 1 CW-1-XX (single-gang faceplate)

¹ Clamshell packaged product. Available in AL, IV, LA, and WH.

² Clamshell packaged product for Canada. Available in LA and WH.

³ "XX" in the model number represents color/finish code; see "Colors and Finishes" on pages 3 &

4. ² For clamshell packaging, add "H" after "153P".

⁴ For 3-way and 4-way switching, use Claro switches or other mechanical switches.

⁵ Clamshell packaged product for Canada.

Specifications

Regulatory Approvals

- U LR Listed to US and Canadian safety requirements UL1472 / CSA C22.2 184.1
- NOM

Power and Ratings

- 120 V~ 60 Hz
- 150 W dimmable LED / CFL *or*
- 600 W incandescent / halogen

or

- Mixed bulb type per **Multigang and Mixed Bulb Type Ratings** table (see page 3)

or

- 250 W Lutron LTEA Hi-lume 1% forward-phase LED driver (maximum 6 drivers)

Environment

- For indoor use only.
- Operating temperatures 32 °F to 104 °F (0 °C to 40 °C).

Performance

- Power-failure memory
- Captive linear slider
- Electrostatic discharge tested
- Precise color matching
- Mechanical air-gap switch to disconnect load power

Warranty

- 1 Year Limited Warranty

For additional Warranty information, please visit www.lutron.com/TechnicalDocumentLibrary/369-119_Wallbox_Warranty.pdf

Dimensions

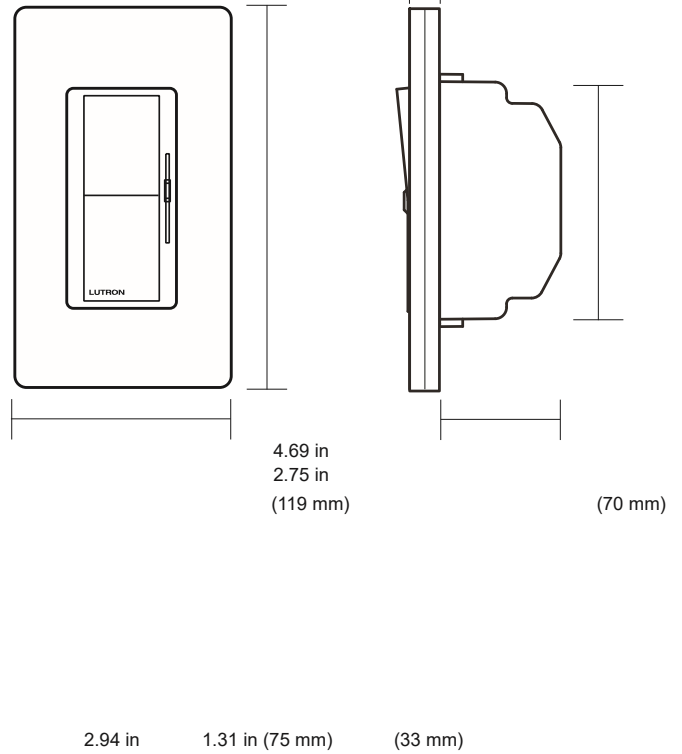

Note: Requires a U.S. wallbox 2` in (64 mm) deep minimum.

Colors and Finishes

Add color/finish code to model #

Example: DVCL-153P-WH

Gloss Finishes

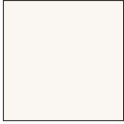

White
WH

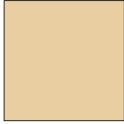

Ivory
IV

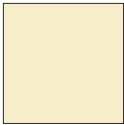

Almond
AL

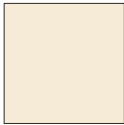

Light Almond
LA



Gray
GR



Brown
BR



Black
BL

Satin Finishes



Brilliant White
BW



Glacier White
GL



Snow
SW



Architectural
White
RW



Lunar Gray
LG



Mist
MI



Pebble
PB



Cobblestone
CS



Slate
SL



Midnight
MN

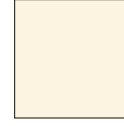

Biscuit
BI



Sand
SD



Taupe
TP



Pumice
PM



Clay
CY



Sage
SA



Espresso
EP



Truffle
TF



Deep Sea
DE



Signal Red
SR

Due to printing limitations, colors and finishes shown cannot be guaranteed to perfectly match actual product colors.

- Color chip keychains are available for more precise color matching:

Gloss Finishes: DG-CK-1

Satin Finishes: SF-CK-1

For coordinating wallplates and accessories, visit lutron.com/claro

Colors and Finishes (cont.)

Satin Colors (while supplies last)



Hot
HT



Merlot
MR



Plum
PL



Turquoise
TQ

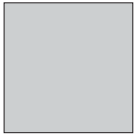

Palladium
PD



Eggshell
ES



Sienna
SI

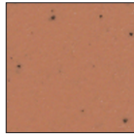

Terracotta
TC

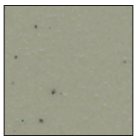

Greenbriar
GB

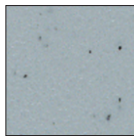

Bluestone
BG

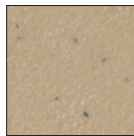

Mocha Stone
MS

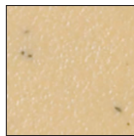

Goldstone
GS



Desert Stone
DS

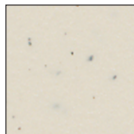

Stone
ST

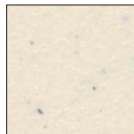

Limestone
LS

Due to printing limitations, colors and finishes shown cannot be guaranteed to perfectly match actual product colors.

- Color chip keychains are available for more precise color matching:
Satin Colors: SC-CK-1 (while supplies last)

Multigang and Mixed-Bulb-Type Ratings

When installing more than one dimmer in the same wallbox, it may be necessary to remove some side sections prior to wiring (**see diagram**). Removal of dimmer side sections may reduce maximum wattage, as shown in the chart below.

Mixing bulb types (**using a combination of LED / CFL, and incandescent / halogen bulbs**) will also affect the maximum ratings, as shown in the chart below.

***EXAMPLE:** If one set of side sections is removed and you have three 10 W LED bulbs installed (Total LED Wattage = 30 W), you may add up to 300 W of incandescent or halogen lighting.

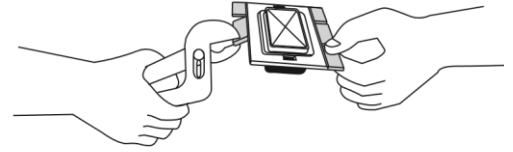
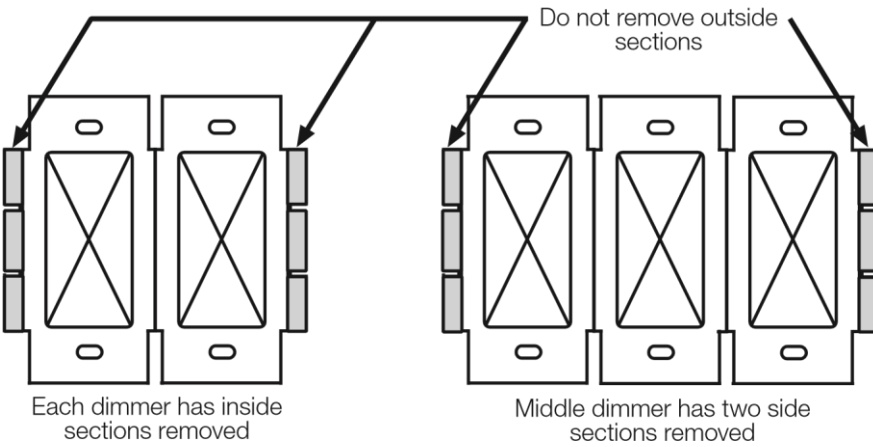

Total LED / CFL Wattage Installed (Wattage per bulb x # of bulbs)	LED CFL	Maximum Allowable Incandescent/Halogen Wattage		
		No sides removed	1 side removed	2 sides removed
0 W	+	600 W	500 W	400 W
1 W – 25 W	+	500 W	400 W	300 W
26 W – 50 W	+	400 W	300 W	200 W
51 W – 75 W	+	300 W	200 W	100 W
76 W – 100 W	+	200 W	100 W	50 W
101 W – 125 W	+	100 W	50 W	0 W
126 W – 150 W	+	0 W	0 W	0 W

Operation (View with wallplate removed)

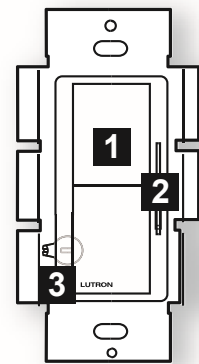

Turns lights ON and OFF. Controls light level.



Increases light level

OR

Down

Decreases light level **IMPORTANT:** Set slider to bottom before adjusting dimming range.

Lever-type Adjustment Dial

Sets low end dimming limit.



Up (clockwise)
Increases brightness

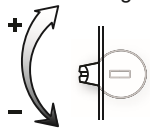

Down (counter-clockwise)
Decreases brightness



Wheel-type Adjustment Dial

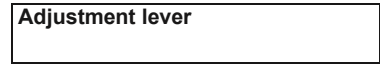

3 Adjustment dial

Sets low end dimming limit.

Up (clockwise)
Decreases brightness

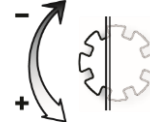

Down (counter-clockwise)
Increases brightness

Wiring Diagrams

Single-Pole Wiring

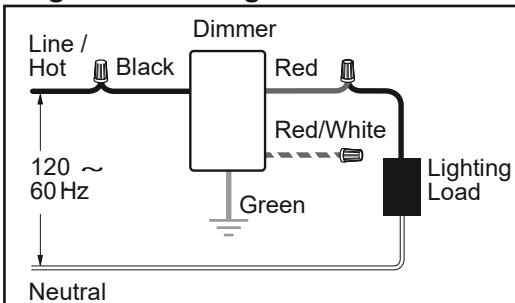

3-Way Wiring

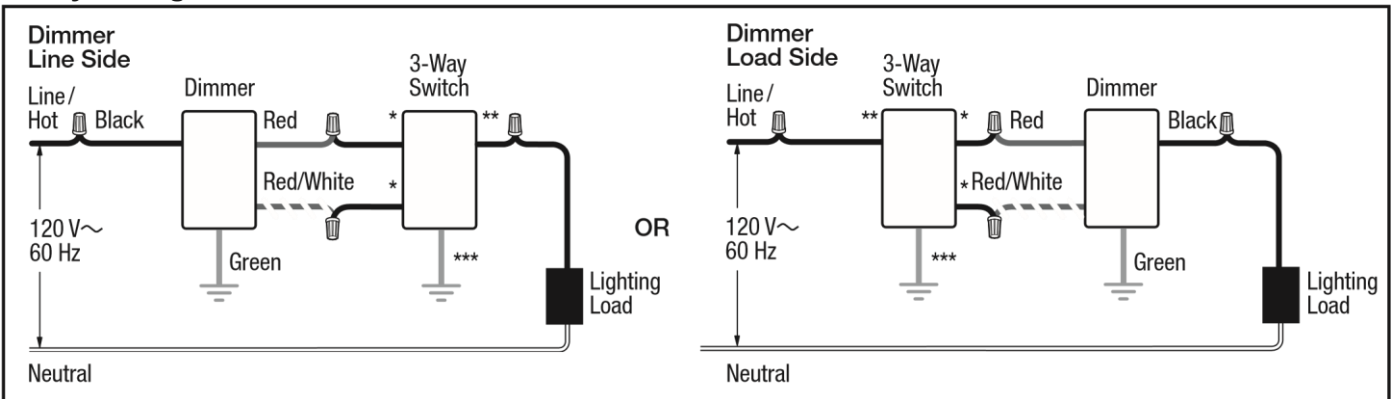

4-Way Wiring

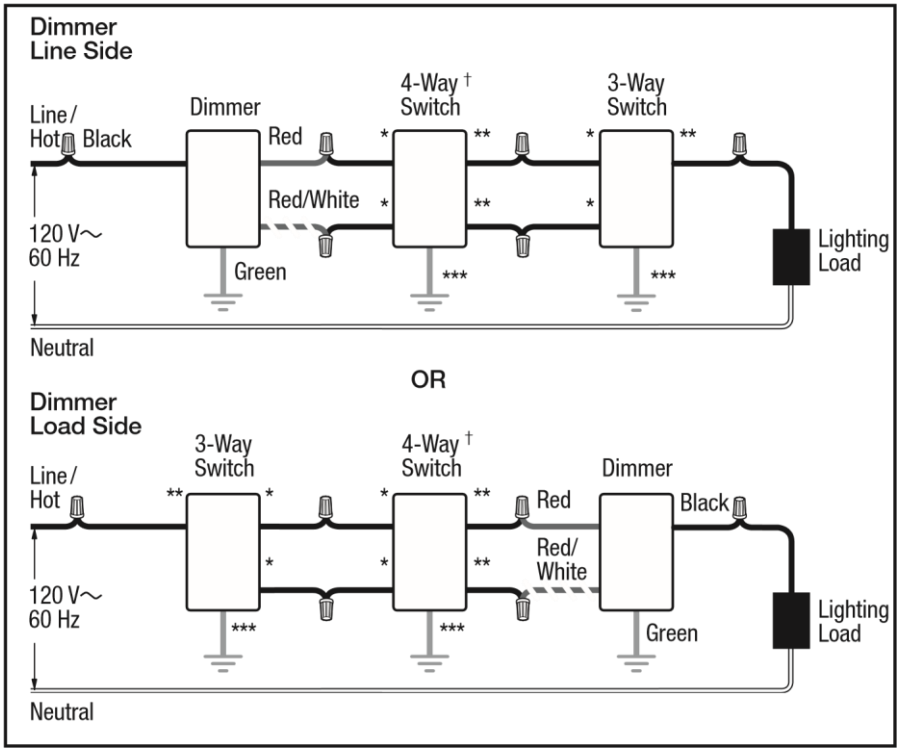

* or Copper / Black screw terminal
 ** or Brass / Gold screw terminal *** or Green screw terminal
 † Please refer to the switch's instruction sheet for proper wiring.

Note for 4-Way Wiring:
 Dimmer must be installed Line Side or Load Side. It cannot be installed in the 4-way location.

The Lutron logo, Lutron, Claro, C•L, Hi-lume, LED+, Satin Colors and Divia are trademarks or registered trademarks of Lutron Electronics Co., Inc. in the US and/or other countries. All other product names, logos, and brands are property of their respective owners.