

## In-wall dimmer PRO

**Welcome**—and thank you for purchasing a Caséta® Wireless in-wall dimmer PRO. In order to control your lights from an app or remote, you'll need to replace an existing switch with a Caséta® Wireless in-wall dimmer PRO.

Before you install the dimmer, please watch the installation video at

[www.casetawireless.com/support](http://www.casetawireless.com/support)

We hope you enjoy the convenience of Caséta® Wireless!

## Double your warranty

Love Caséta® Wireless dimmers? Have ideas for making them better? Tell us what you think and we'll extend your warranty by 1 year.

[www.casetawireless.com/register](http://www.casetawireless.com/register)



## Contents supplied

In-wall dimmer PRO (PD-10NXD)

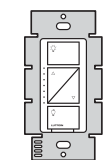

Wire connectors



Screws

x5

x2

## Tools you'll need

Flat-head screwdriver



Pliers



Phillips-head screwdriver



P/N 0301778 REV A

## Installing your dimmer Installation for lights with one wall switch (single pole)

### 1 Turn power off at circuit breaker!

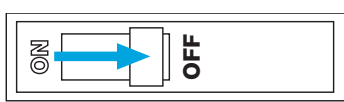

**WARNING: SHOCK HAZARD**  
May result in serious injury or death. Turn off power at circuit breaker or fuse before installing.

### 2 Remove existing switch from wall

Remove the wallplate from switch.

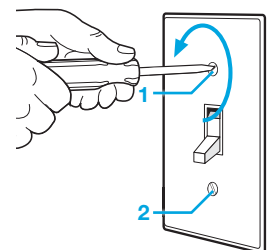

Remove the switch and pull it away from the wall.

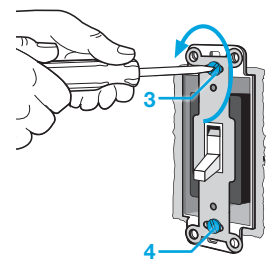

Disconnect all three wires\* from the switch.

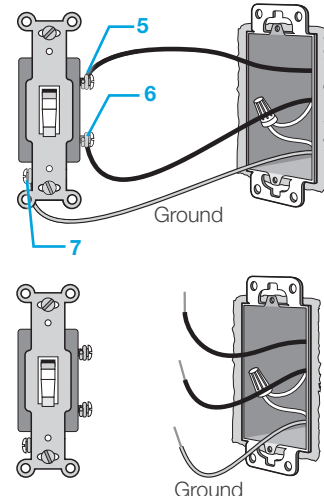

\*If your switch has more than 3 wires attached, see "Installing Caséta® Wireless in a 3-way switch application" video at [www.casetawireless.com/3way](http://www.casetawireless.com/3way)

### 3 Remove side sections (if necessary)

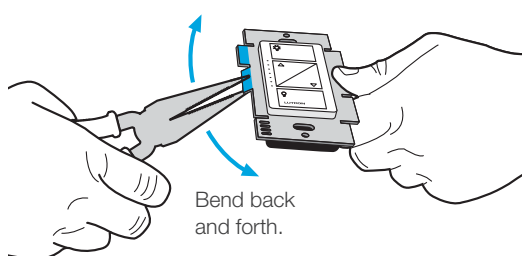

**Do not** remove outside side sections on dimmers at the end of gang.

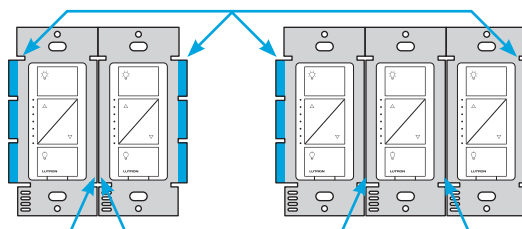

Each dimmer has inside side sections removed.

Dimmer at middle has all side sections removed.

## Important note:

Removing side sections reduces the dimmer's maximum wattage rating. See the chart below for maximum wattage information.

### Maximum\* wattage derating chart (120 V~ 50/60 Hz)

Side sections removed	None	1 side	2 sides
LED	250 W	250 W	250 W
<b>or*</b>			
Incandescent & Halogen	1000 W	800 W	600 W
MLV Halogen	1000 VA	800 VA	600 VA

\*For maximum wattage information when mixing light bulb types see [www.casetawireless.com/ganging](http://www.casetawireless.com/ganging)

### 4 Connect the dimmer

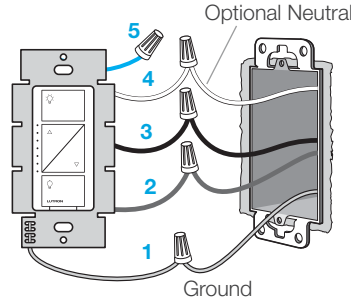

1 Connect the bare copper (or green) "ground" wire from the wallbox to the green wire on the dimmer using a wire connector.

2 Connect the load wire from the wallbox to the red wire on the dimmer using a wire connector.

3 Connect the hot wire from the wallbox to the black wire on the dimmer using a wire connector.

4 If available, connect the neutral wire from the wallbox to the white wire on the dimmer. If neutral is not available, cap the white wire with a wire connector.

Neutral required for: MLV loads, LED drivers, PHPM-PA, PHPM-3F, GRX-TVI.

5 Cap the blue wire with a wire connector. (The blue wire is only used for a 3-way installation with a mechanical toggle switch. See [www.casetawireless.com/3-way](http://www.casetawireless.com/3-way) for details.)

### 5 Mount the dimmer

Use the screws provided.

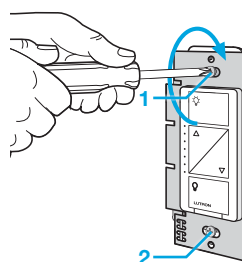

### 6 Attach the wallplate

Attach the adapter to the dimmer using the screws provided and snap on the wallplate.

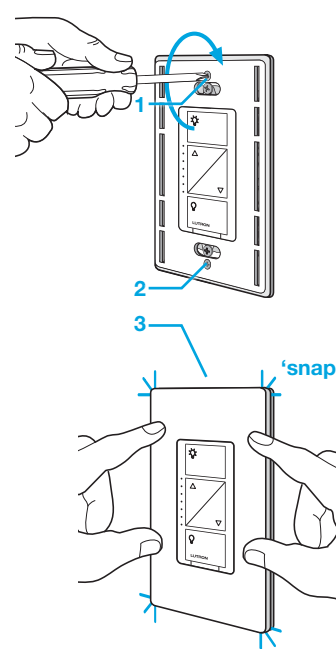

(If you installed the dimmer next to other dimmers or switches, you'll need to install a wallplate with the correct size/number of openings to accommodate all the devices.)

### 7 Turn power on at circuit breaker

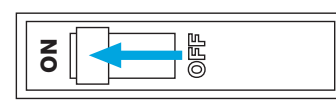

## CAUTION

Use only with permanently installed fixtures with dimmable LED, halogen, MLV halogen, or incandescent lamps. To avoid overheating and possible damage to other equipment, do not use to control receptacles, motor-driven appliances.

## Codes

Install in accordance with all national and local electrical codes.

## Grounding

When no "grounding means" exist in wallbox, the National Electrical Code (NEC®) allows a control to be installed as a replacement if 1) a nonmetallic, noncombustible faceplate is used with nonmetallic attachment screws or 2) the circuit is protected by a ground fault circuit interrupter (GFCI). When installing a control according to these methods, cap or remove green wire before screwing control into wallbox.

## FCC/IC Information

This device complies with part 15 of the FCC Rules and Industry Canada license-exempt RSS standard(s). Operation is subject to the following two conditions: (1) This device may not cause interference, and (2) this device must accept any interference, including interference that may cause undesired operation. Modifications not expressly approved by Lutron Electronics Co., Inc. could void the user's authority to operate this equipment. Note: This equipment has been tested and found to comply with the limits for a Class B digital device, pursuant to part 15 of the FCC Rules. These limits are designed to provide reasonable protection against harmful interference in a residential installation. This equipment generates, uses and can radiate radio frequency energy and, if not installed and used in accordance with the instructions, may cause harmful interference to radio communications. However, there is no guarantee that interference will not occur in a particular installation. If this equipment does cause harmful interference to radio or television reception, which can be determined by turning the equipment off and on, the user is encouraged to try to correct the interference by one or more of the following measures:  
—Reorient or relocate the receiving antenna.  
—Increase the separation between the equipment and receiver.  
—Connect the equipment into an outlet on a circuit different from that to which the receiver is connected.  
—Consult the dealer or an experienced radio/TV technician for help.

## Warranty

For warranty information, please visit [www.casetawireless.com/warranty](http://www.casetawireless.com/warranty)

Works with compatible energy efficient dimmable light bulbs:

**LED\***—up to 250 W

**Incandescent/Halogen**—up to 1000 W

**MLV Halogen**—up to 1000 VA

**NOTE:** You can mix and match dimmable LEDs, as well as halogen and incandescent light bulbs, with Caséta® Wireless dimmers.

Dimmable LED light bulbs vary in their dimming performance. If you're using these bulbs and they flicker or turn off, please visit [www.casetawireless.com/lowend](http://www.casetawireless.com/lowend) for information on adjusting the dimmer for best bulb performance.

\* For a complete list of compatible dimmable LEDs, please visit [www.casetawireless.com/bulblist](http://www.casetawireless.com/bulblist)

Compatible light bulbs include:

**EcoSmart®**  
ECS BR30 W27 FL 120  
ECS 20 WW FL 50WE 120

**Feit®**  
A19/OM/LED

**Philips®**  
9290002295

**Sylvania®**  
LED12A19/DIM/O/827  
LED21PAR38/DIM/P/930/FL30

## Using your Caséta® Wireless kit (sold separately)

### With a smartphone or tablet (Bridge required, sold separately)

The Caséta® Wireless dimmer can be controlled from a smartphone when used with the Lutron® Smart Bridge™.

If you are using the dimmer and remote control with the Lutron® Smart Bridge™, follow the instructions below.

Note: If you are using the dimmer and remote control with another manufacturer's bridge, please refer to that manufacturer's instructions for set-up.



Lutron® Smart Bridge™

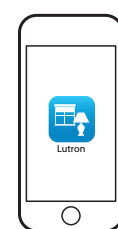

Lutron® app

### 1 Download the Lutron® app



Search for "Lutron Caseta"



Lutron™



[www.casetawireless.com/LutronApp](http://www.casetawireless.com/LutronApp)

Apple is a trademark of Apple Inc., registered in the U.S. and other countries. App Store is a service mark of Apple Inc.

### 2 Launch the Lutron® app



The Lutron® app will walk you through setting up your devices.

### 3 Use the Lutron® app to complete ALL remaining steps



Add devices  
• Pico® remotes  
• Dimmers  
• Shades



Control three ways



Schedule your lights



Connect while away

### Without a smartphone or tablet (Bridge not required)

#### Pairing the dimmer and Pico® remote control

### 1 Press and hold "off" button on dimmer

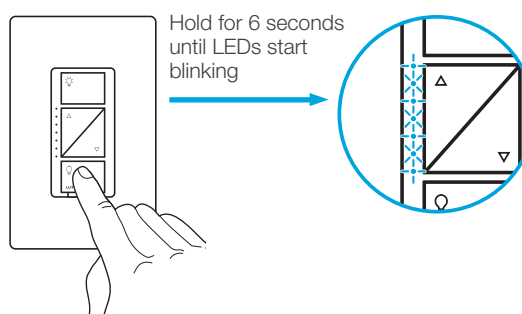

### 2 Press and hold "off" button on remote

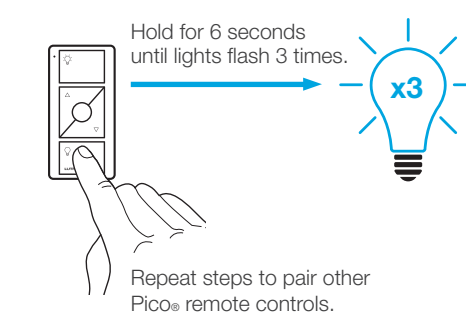

Repeat steps to pair other Pico® remote controls.

#### Changing the favorite light level on the Pico® remote control (sold separately)

You can use the round "favorite" button on the Pico® remote control to recall a favorite light level. We've set it to 50%, but you can change it to any level you like.

### 3 Set desired light level on dimmer

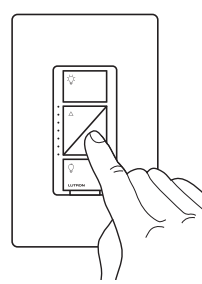

### 4 Press and hold "favorite" button on remote

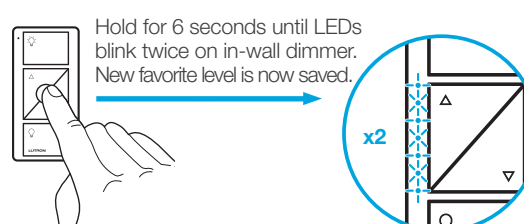

## Using your controls

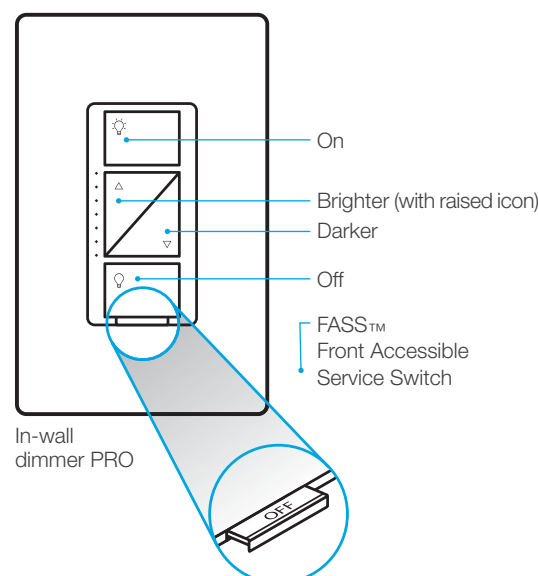

**Replacing light bulbs using FASS™**  
Pull the FASS™ switch out on the in-wall dimmer PRO to remove power at the light socket.

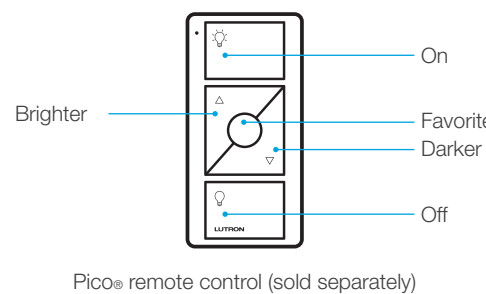

## Important notes:

- For indoor use only.
- Operate between 32 F (0 C) and 104 F (40 C).

## Device Ratings

In-wall dimmer PRO  
PD-10NXD  
120 V~ 50/60 Hz

## Troubleshooting

Symptoms	Probable cause and action
Light does not turn on or in-wall dimmer PRO LEDs do not light up.	<ul style="list-style-type: none"> <li>Light bulb(s) burned out.</li> <li>Breaker is OFF or tripped.</li> <li>Light not properly installed.</li> <li>Wiring error.</li> <li>FASS™ switch on the dimmer is in the Off position.</li> </ul>

Light does not respond to Pico® remote control.	<ul style="list-style-type: none"> <li>The dimmer failed to pair with Pico® remote control; see <i>Pairing the dimmer and Pico® remote control</i>.</li> <li>The dimmer is already at the light level the Pico® remote control is sending.</li> <li>The Pico® remote control is outside the 30 ft (9 m) operating range.</li> <li>The Pico® remote control battery is low.</li> <li>The Pico® remote control battery is installed incorrectly.</li> </ul>
---	---

<ul style="list-style-type: none"> <li>Bulbs turn off while being dimmed.</li> <li>Bulbs turn on at high light level but do not turn on at a low light level.</li> <li>Bulbs flicker or flash when dimmed to a low light level.</li> </ul>	<ul style="list-style-type: none"> <li>Verify bulbs are marked dimmable and visit <a href="http://www.casetawireless.com/lowend">www.casetawireless.com/lowend</a> for information on adjusting the dimmer for best bulb performance.</li> </ul>
--	--

Go to [www.casetawireless.com/support](http://www.casetawireless.com/support) for additional troubleshooting suggestions.

