

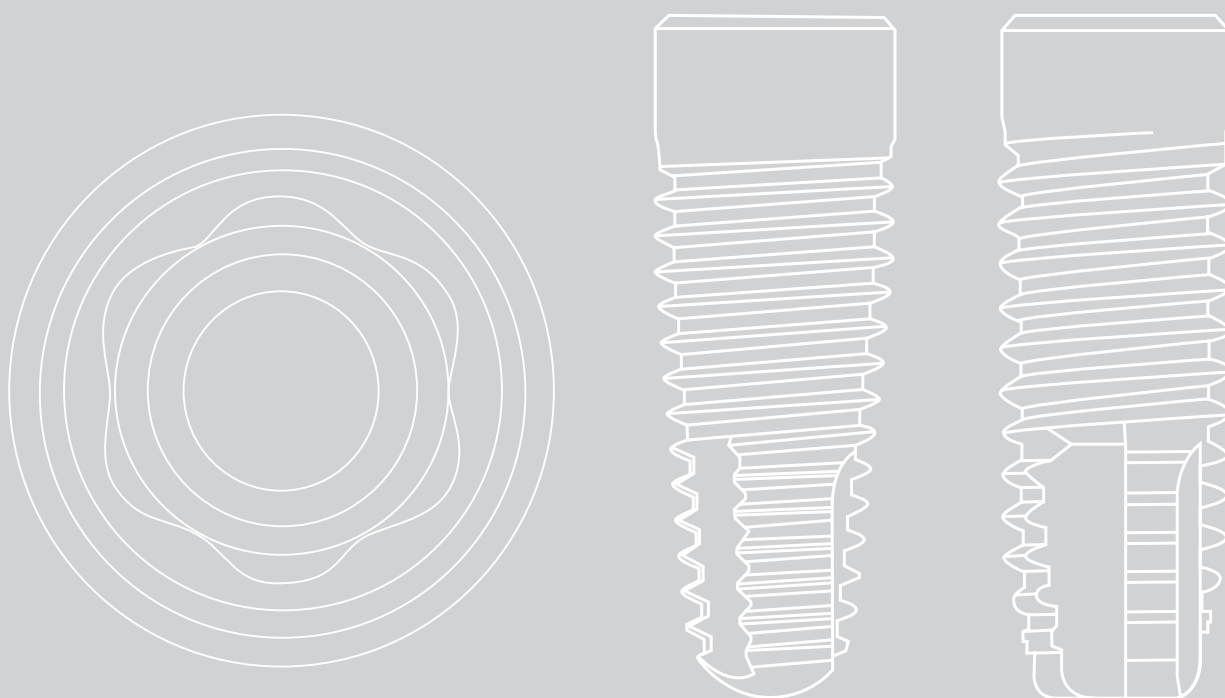

Smarter Thinking. Simpler Design.



# PrimaConnex<sup>®</sup> & PrimaSolo<sup>®</sup>

Product Catalog



## PrimaConnex®

Ø3.5 mm PrimaConnex® Implants	6
Ø3.5 mm Prosthetic Options	7
Ø3.5 mm Prosthetic Components	8
Ø4.1 mm PrimaConnex® Implants	12
Ø4.1 mm Prosthetic Options	13
Ø4.1 mm Prosthetic Components	14
Ø5.0 mm PrimaConnex® Implants	18
Ø5.0 mm Prosthetic Options	19
Ø5.0 mm Prosthetic Components	20

## Digital

Imagine™ Milling Services	25
Core3dcentres®	28
In-Office Milling	30

## LOCATOR® Abutments

LOCATOR® Prosthetic Options	32
LOCATOR® Abutment	33
LOCATOR® R-Tx™ Abutment	34
LOCATOR® F-Tx™ Abutment	35



## PrimaSolo®

Ø3.0 mm PrimaSolo® Implants	37
Ø3.5 mm SD PrimaSolo® Implants	39
Ø4.1 mm RD PrimaSolo® Implants	41
Ø5.0 mm WD PrimaSolo® Implants	43

## Surgical Kits & Instrumentation

PrimaConnex® Surgical Kit	46
PrimaConnex® Guided Surgical Kit	52

## Surgical Motors & Accessories

Surgical Motors	56
Surgical Motor Accessories	58
Terms & Conditions	59

\*Product specifications are subject to change without notice.  
Items illustrated are not to scale.





**PrimaConnex<sup>®</sup>**



PrimaConnex® Implants  
Tapered\*

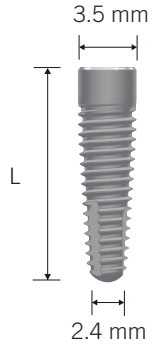

Catalog #

- 15413K**
- 15414K**
- 15415K**
- 15416K**

Implant Size

- Ø3.5 x 10 mm Length
- Ø3.5 x 11.5 mm Length
- Ø3.5 x 13 mm Length
- Ø3.5 x 15 mm Length

- 15613K**
- 15614K**
- 15615K**
- 15616K**

- Ø3.5 x 10 mm Length TC
- Ø3.5 x 11.5 mm Length TC
- Ø3.5 x 13 mm Length TC
- Ø3.5 x 15 mm Length TC

PrimaConnex® Implants  
Straight\*

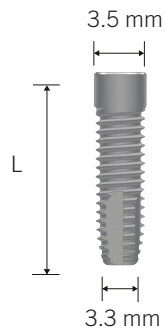

Catalog #

- 15425K**
- 15426K**
- 15427K**
- 15428K**

Implant Size

- Ø3.3 x 10 mm Length
- Ø3.3 x 11.5 mm Length
- Ø3.3 x 13 mm Length
- Ø3.3 x 15 mm Length

- 15625K**
- 15626K**
- 15627K**
- 15628K**

- Ø3.3 x 10 mm Length TC
- Ø3.3 x 11.5 mm Length TC
- Ø3.3 x 13 mm Length TC
- Ø3.3 x 15 mm Length TC

Cover Screw



Catalog #

- 15300K**

Description

- Ø3.5 mm

Healing Abutments



Catalog #

- 15301K**
- 15302K**
- 15303K**

Description

- Ø3.5 mm
- Ø3.5 mm
- Ø3.5 mm

Flare

- Straight
- Straight
- Straight

Cuff Height

- 3.0 mm
- 5.0 mm
- 7.0 mm

- 15317K**
- 15318K**

- Ø3.5 mm
- Ø3.5 mm

- 4.0 mm
- 4.0 mm

- 3.0 mm
- 5.0 mm

- 15304K**
- 15305K**

- Ø3.5 mm
- Ø3.5 mm

- 5.0 mm
- 5.0 mm

- 3.0 mm
- 5.0 mm

\*All PrimaConnex® implant sizes are available with either a 1.0 mm machined collar or Total Coverage (TC).

The Ø3.5 mm PrimaConnex® can be restored with straight, Ø4.0 and Ø5.0 mm flared prosthetic components. An Abutment Screw is included with all TiLobe abutments.

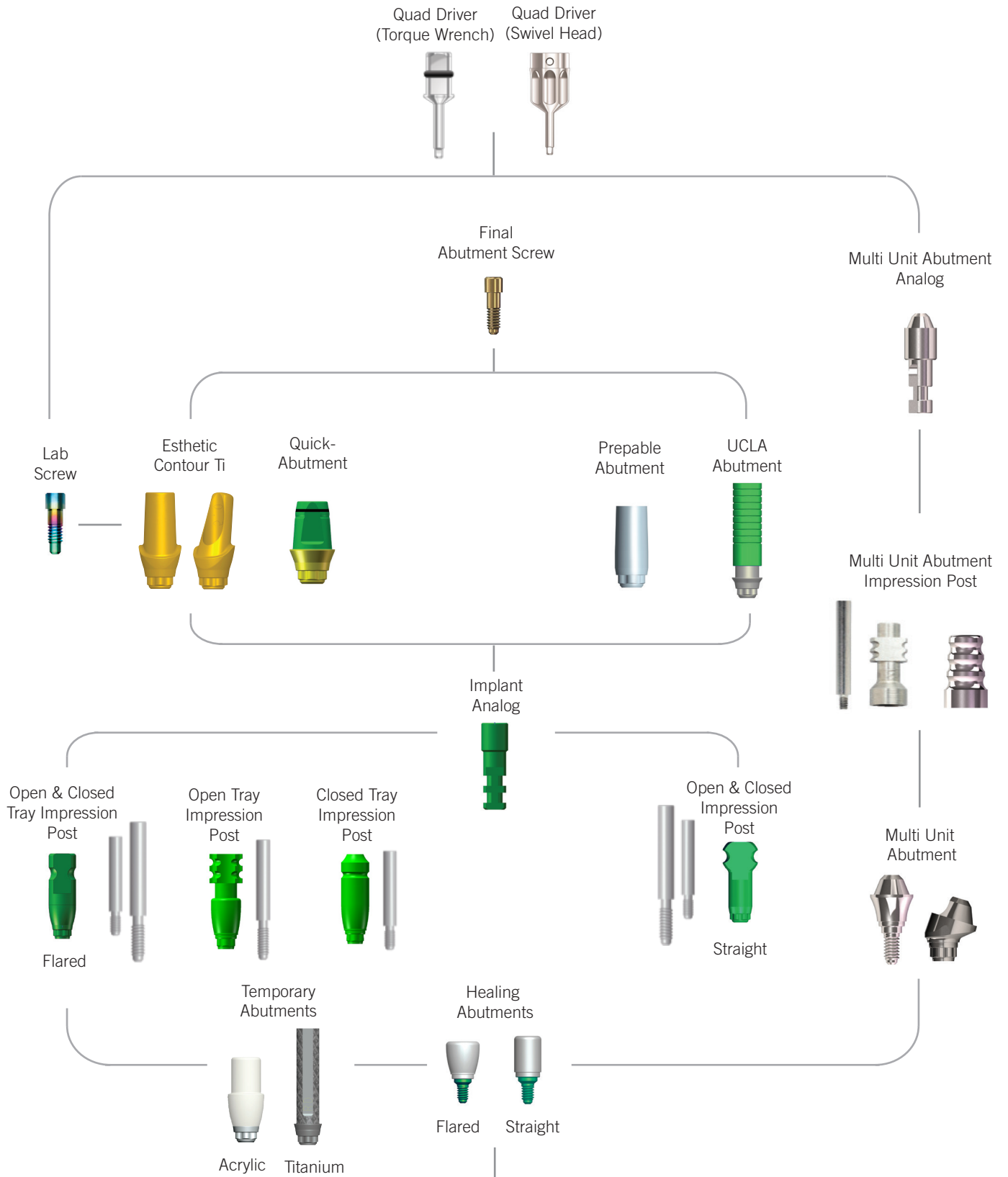









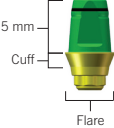

# Prosthetic Components

## Internal TiLobe®

	Catalog #	Description	Flare	
Open & Closed Tray Impression Post	45130K	Ø3.5 mm	Straight	
	45136K	Ø3.5 mm	4.0 mm	
	45131K	Ø3.5 mm	5.0 mm	
Open Tray Impression Post	45904K	Ø3.5 mm	4.0 mm	
	45906K	Ø3.5 mm	5.0 mm	
Closed Tray Impression Post	45905K	Ø3.5 mm	4.0 mm	
	45907K	Ø3.5 mm	5.0 mm	
Implant Analog	45140K	Ø3.5 mm, 1-Pack		
	45143K	Ø3.5 mm, 10-Pack		
Temporary Abutment	45118K	Ø3.5 mm, Locking	4.0 mm	
	45119K	Ø3.5 mm, Non-Locking	4.0 mm	
	45112K	Ø3.5 mm, Locking	5.0 mm	
Ti Temporary Abutment	45075K	Ø3.5 mm, Locking		
	45076K	Ø3.5 mm, Non-Locking		
Esthetic Contour Ti Abutment	45046K	Ø3.5 mm, Straight	4.0 mm	1.0 mm
	45047K	Ø3.5 mm, Straight	4.0 mm	2.0 mm
	45048K	Ø3.5 mm, 15° Angled	4.0 mm	1.0 mm
	45049K	Ø3.5 mm, 15° Angled	4.0 mm	2.0 mm
	45030K	Ø3.5 mm, Straight	5.0 mm	1.0 mm
	45031K	Ø3.5 mm, Straight	5.0 mm	3.0 mm
	45032K	Ø3.5 mm, 15° Angled	5.0 mm	1.0 mm
45033K	Ø3.5 mm, 15° Angled	5.0 mm	3.0 mm	
UCLA Abutment	45100K	Gold/Plastic Sleeve, Locking		1.0 mm
	45101K	Gold/Plastic Sleeve, Non-Locking		1.0 mm



Replacement Final Abutment Screw		Catalog #	Description		
		<b>45060K</b>	1-Pack		
Laboratory Screw		Catalog #	Description		
		<b>45061K</b>	10-Pack		
Quick-Packs		Catalog #	Description	Flare	Cuff Height
		<b>45400K</b>	Ø3.5 mm	5.0 mm	1.0 mm
		<b>45401K</b>	Ø3.5 mm	5.0 mm	2.0 mm
		<b>45402K</b>	Ø3.5 mm	5.0 mm	3.0 mm
		<b>45403K</b>	Ø3.5 mm	5.0 mm	4.0 mm
Quick-Abutment		Catalog #	Description	Flare	Cuff Height
		<b>45420K</b>	Ø3.5 mm	5.0 mm	1.0 mm
		<b>45421K</b>	Ø3.5 mm	5.0 mm	2.0 mm
		<b>45422K</b>	Ø3.5 mm	5.0 mm	3.0 mm
		<b>45423K</b>	Ø3.5 mm	5.0 mm	4.0 mm
Quick-Abutment Quick-Cap®		Catalog #	Description	Flare	
		<b>45432K</b>	Ø3.5 mm, 1-Pack	5.0 mm	
Quick-Abutment Temporary/Healing Cap		Catalog #	Description	Flare	
		<b>45209K</b>	Ø3.5 mm	5.0 mm	
Quick-Abutment Analog		Catalog #	Description	Flare	
		<b>45445K</b>	Ø3.5 mm	5.0 mm	
Quick-Abutment Plastic Sleeve		Catalog #	Description	Flare	
		<b>45215K</b>	Ø3.5 mm, Locking	5.0 mm	
		<b>45218K</b>	Ø3.5 mm, Non-Locking	5.0 mm	
Quick-Abutment Ceramic Coping		Catalog #	Description	Flare	
		<b>45301K</b>	Ø3.5 mm	5.0 mm	

Quick-Abutment Plastic Sleeve  
Reamer Tool

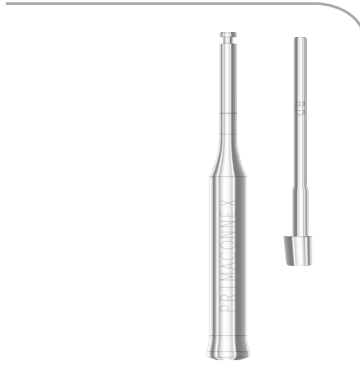

Catalog #

**45311K**

Description

Reamer Tool and Centering Pins

Prepable Abutment



Catalog #

**45042K**

Description

Ø3.5 mm

Multi Unit Abutment

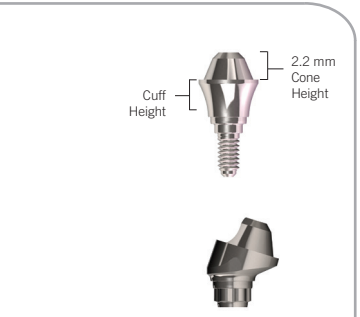

Catalog #

**45312K**

Description

Ø3.5 mm, Straight

Cuff Height

1.0 mm

**45313K**

Ø3.5 mm, Straight

2.0 mm

**45314K**

Ø3.5 mm, Straight

3.0 mm

**45321K**

Ø3.5 mm, Angled, 17°

3.0 mm

**45322K**

Ø3.5 mm, Angled, 17°

4.0 mm

**45936K**

Ø3.5 mm, Angled, 30°

3.0 mm

**45937K**

Ø3.5 mm, Angled, 30°

4.0 mm

**45938K**

Ø3.5 mm, Angled, 30°

5.0 mm

Multi Unit Abutment  
Healing Cap



Catalog #

**45330K**

Description

Ø3.5 mm

Multi Unit Abutment  
Impression Post



Catalog #

**45327K**  
**45328K**

Description

Open Tray, Ø3.5 mm with screw  
Closed Tray, Ø3.5 mm

Multi Unit Abutment  
Analog



Catalog #

**45329K**

Description

Ø3.5mm

Multi-Unit Abutment  
Ti Temporary Sleeve

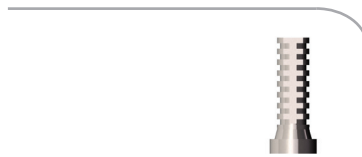

Catalog #

**45331K**

Description

Ø3.5 mm

Multi Unit Abutment  
Plastic Sleeve



Catalog #

**45332K**

Description

Ø3.5 mm

Multi Unit Abutment  
Prosthetic Screw



Catalog #

**45333K**

Description

1-Pack

Angled Multi-Unit Abutment  
Replacement Screw



Catalog #

**45334K**

Description

1-Pack

PrimaConnex® Implants  
Tapered\*

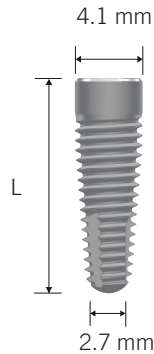

Catalog #

**15417K**  
**15418K**  
**15419K**  
**15420K**

Implant Size

Ø4.1 x 10 mm Length  
Ø4.1 x 11.5 mm Length  
Ø4.1 x 13 mm Length  
Ø4.1 x 15 mm Length

**15617K**  
**15618K**  
**15619K**  
**15620K**

Ø4.1 x 10 mm Length TC  
Ø4.1 x 11.5 mm Length TC  
Ø4.1 x 13 mm Length TC  
Ø4.1 x 15 mm Length TC

PrimaConnex® Implants  
Straight\*

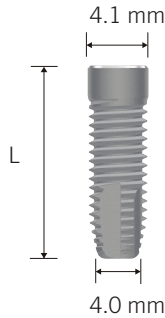

Catalog #

**15429K**  
**15430K**  
**15431K**  
**15432K**  
**15433K**

Implant Size

Ø4.0 x 8 mm Length  
Ø4.0 x 10 mm Length  
Ø4.0 x 11.5 mm Length  
Ø4.0 x 13 mm Length  
Ø4.0 x 15 mm Length

**15629K**  
**15630K**  
**15631K**  
**15632K**  
**15633K**

Ø4.0 x 8 mm Length TC  
Ø4.0 x 10 mm Length TC  
Ø4.0 x 11.5 mm Length TC  
Ø4.0 x 13 mm Length TC  
Ø4.0 x 15 mm Length TC

Cover Screw



Catalog #

**15306K**

Description

Ø4.1 mm

Healing Abutments



Catalog #

**15307K**  
**15308K**  
**15309K**

Description

Ø4.1 mm  
Ø4.1 mm  
Ø4.1 mm

Flare

Straight  
Straight  
Straight

Cuff Height

3.0 mm  
5.0 mm  
7.0 mm

**15319K**  
**15320K**

Ø4.1 mm  
Ø4.1 mm

5.0 mm  
5.0 mm

3.0 mm  
5.0 mm

**15310K**  
**15311K**

Ø4.1 mm  
Ø4.1 mm

6.0 mm  
6.0 mm

3.0 mm  
5.0 mm

\*All PrimaConnex® implant sizes are available with either a 1.0 mm machined collar or Total Coverage (TC).

The Ø4.1 mm PrimaConnex® can be restored with straight, Ø5.0 and Ø6.0 mm flared prosthetic components. An Abutment Screw is included with all TiLobe abutments.

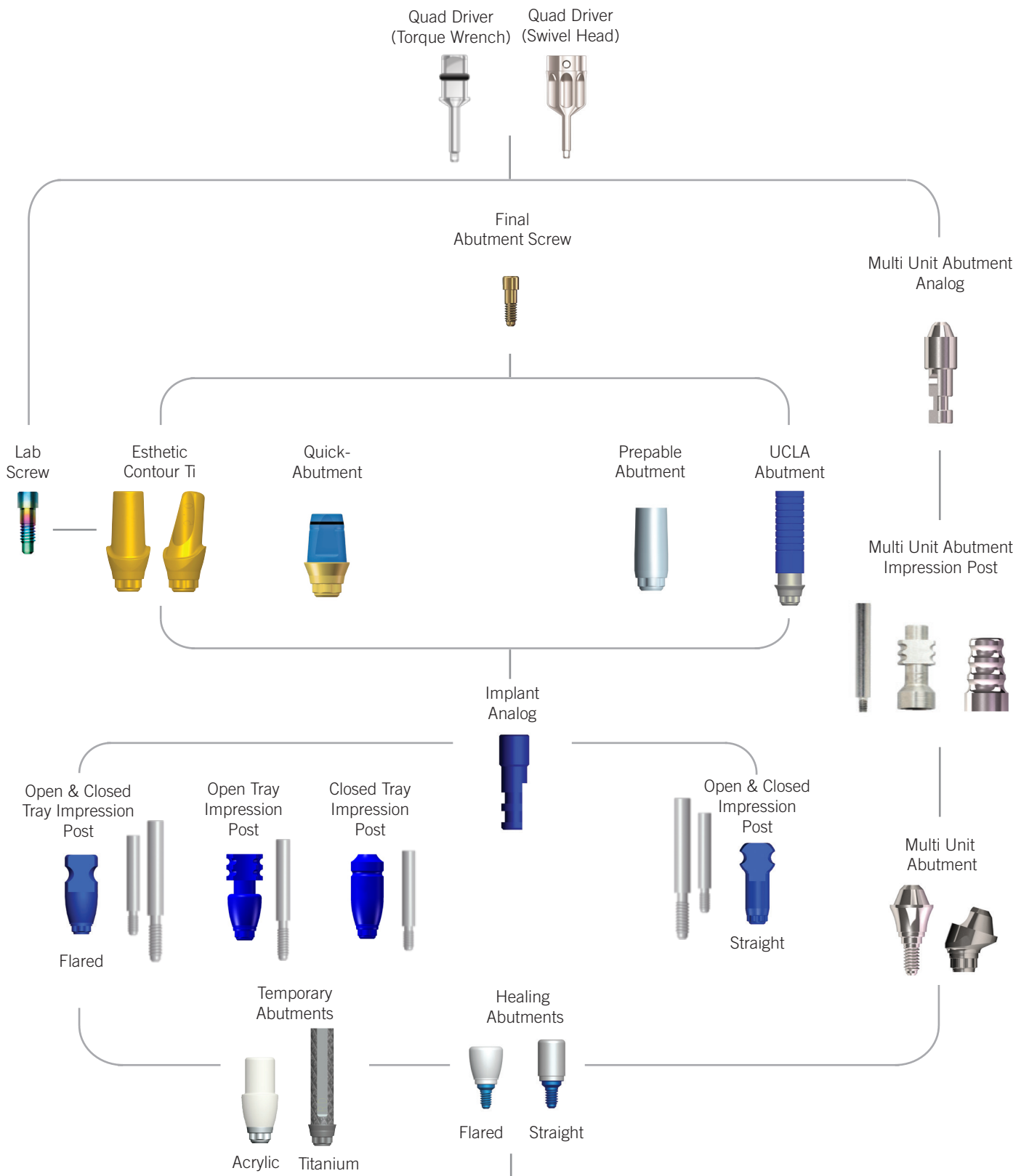

Open & Closed Tray Impression Post	Catalog #	Description	Flare	
	45132K	Ø4.1 mm	Straight	
	45137K	Ø4.1 mm	5.0 mm	
	45133K	Ø4.1 mm	6.0 mm	
Open Tray Impression Post	Catalog #	Description	Flare	
	45908K	Ø4.1 mm	5.0 mm	
	45910K	Ø4.1mm	6.0 mm	
Closed Tray Impression Post	Catalog #	Description	Flare	
	45909K	Ø4.1mm	5.0 mm	
	45911K	Ø4.1 mm	6.0 mm	
Implant Analog	Catalog #	Description		
	45141K	Ø4.1 mm, 1-Pack		
	45144K	Ø4.1 mm, 10-Pack		
Temporary Abutment	Catalog #	Description	Flare	
	45120K	Ø4.1 mm, Locking	5.0 mm	
	45121K	Ø4.1 mm, Non-Locking	5.0 mm	
	45114K	Ø4.1 mm, Locking	6.0 mm	
Ti Temporary Abutment	Catalog #	Description		
	45077K	Ø4.1 mm, Locking		
	45078K	Ø4.1 mm, Non-Locking		
Esthetic Contour Ti Abutment	Catalog #	Description	Flare	Cuff Height
 Cuff Height (Buccal)	45050K	Ø4.1 mm, Straight	5.0 mm	0.5 mm
	45051K	Ø4.1 mm, Straight	5.0 mm	1.5 mm
	45052K	Ø4.1 mm, 15° Angled	5.0 mm	0.5 mm
	45053K	Ø4.1 mm, 15° Angled	5.0 mm	1.5 mm
	45034K	Ø4.1 mm, Straight	6.0 mm	1.0 mm
	45035K	Ø4.1 mm, Straight	6.0 mm	3.0 mm
	45036K	Ø4.1 mm, 15° Angled	6.0 mm	1.0 mm
45037K	Ø4.1 mm, 15° Angled	6.0 mm	3.0 mm	
UCLA Abutment	Catalog #	Description	Cuff Height	
	45102K	Gold/Plastic Sleeve, Locking	1.0 mm	
	45103K	Gold/Plastic Sleeve, Non-Locking	1.0 mm	

Final Abutment Screw Replacement



Catalog #	Description
45060K	1-Pack

Laboratory Screw



Catalog #	Description
45061K	10-Pack

Quick-Packs



Catalog #	Description	Flare	Cuff Height
45412K	Ø4.1 mm	5.0 mm	0.5 mm
45413K	Ø4.1 mm	5.0 mm	1.5 mm
45414K	Ø4.1 mm	5.0 mm	2.5 mm
45415K	Ø4.1 mm	5.0 mm	4.0 mm
45404K	Ø4.1 mm	6.0 mm	0.5 mm
45405K	Ø4.1 mm	6.0 mm	1.5 mm
45406K	Ø4.1 mm	6.0 mm	2.5 mm
45407K	Ø4.1 mm	6.0 mm	4.0 mm

Quick-Abutment

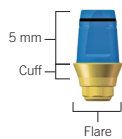

Catalog #	Description	Flare	Cuff Height
45435K	Ø4.1 mm	5.0 mm	0.5 mm
45436K	Ø4.1 mm	5.0 mm	1.5 mm
45437K	Ø4.1 mm	5.0 mm	2.5 mm
45438K	Ø4.1 mm	5.0 mm	4.0 mm
45424K	Ø4.1 mm	6.0 mm	0.5 mm
45425K	Ø4.1 mm	6.0 mm	1.5 mm
45426K	Ø4.1 mm	6.0 mm	2.5 mm
45427K	Ø4.1 mm	6.0 mm	4.0 mm

Quick-Abutment Quick-Cap®



Catalog #	Description	Flare
45443K	Ø4.1 mm, 1-Pack	5.0 mm
45433K	Ø4.1 mm, 1-Pack	6.0 mm

Quick-Abutment Temporary/Healing Cap



Catalog #	Description	Flare
45236K	Ø4.1 mm	5.0 mm
45210K	Ø4.1 mm	6.0 mm

Quick-Abutment Analog



Catalog #	Description	Flare
45448K	Ø4.1 mm	5.0 mm
45446K	Ø4.1 mm	6.0 mm

Quick-Abutment Plastic Sleeve



Catalog #	Description	Flare
45240K	Ø4.1 mm, Locking	5.0 mm
45242K	Ø4.1 mm, Non-Locking	5.0 mm
45216K	Ø4.1 mm, Locking	6.0 mm
45219K	Ø4.1 mm, Non-Locking	6.0 mm

Quick-Abutment Ceramic Coping



Catalog #	Description	Flare
45244K	Ø4.1 mm	5.0 mm
45302K	Ø4.1 mm	6.0 mm

Quick-Abutment Plastic Sleeve Reamer Tool



Catalog #	Description
45311K	Reamer Tool and Centering Pins

Prepable Abutment



Catalog #	Description
45043K	Ø4.1 mm

Multi Unit Abutment

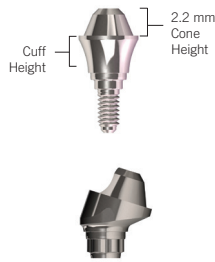

Catalog #	Description	Cuff Height
45315K	Ø4.1 mm, Straight	1.0 mm
45316K	Ø4.1 mm, Straight	2.0 mm
45317K	Ø4.1mm, Straight	3.0 mm
45318K	Ø4.1 mm, Straight	4.0 mm
45323K	Ø4.1 mm, Angled, 17°	3.0 mm
45324K	Ø4.1 mm, Angled, 17°	4.0 mm
45965K	Ø4.1 mm, Angled, 30°	3.0 mm
45325K	Ø4.1mm, Angled, 30°	4.0 mm
45326K	Ø4.1 mm, Angled, 30°	5.0 mm



Multi Unit Abutment  
Healing Cap



Catalog #	Description
<b>45330K</b>	Ø4.1 mm

Multi Unit Abutment  
Impression Post



Catalog #	Description
<b>45327K</b>	Open Tray, Ø4.1 mm with screw
<b>45328K</b>	Closed Tray, Ø4.1 mm

Multi Unit Abutment  
Analog

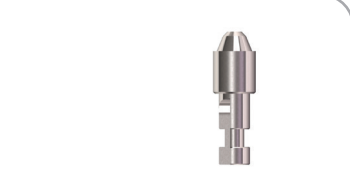

Catalog #	Description
<b>45329K</b>	Ø4.1 mm

Multi-Unit Abutment  
Ti Temporary Sleeve



Catalog #	Description
<b>45331K</b>	Ø4.1 mm

Multi Unit Abutment  
Plastic Sleeve



Catalog #	Description
<b>45332K</b>	Ø4.1 mm

Multi Unit Abutment  
Prosthetic Screw



Catalog #	Description
<b>45333K</b>	1-Pack

Angled Multi-Unit Abutment  
Replacement Screw



Catalog #	Description
<b>45334K</b>	1-Pack



PrimaConnex® Implants  
Tapered\*



Catalog #

Implant Size

- 15421K**
- 15422K**
- 15423K**
- 15424K**

- Ø5.0 x 10 mm Length
- Ø5.0 x 11.5 mm Length
- Ø5.0 x 13 mm Length
- Ø5.0 x 15 mm Length

- 15621K**
- 15622K**
- 15623K**
- 15624K**

- Ø5.0 x 10 mm Length TC
- Ø5.0 x 11.5 mm Length TC
- Ø5.0 x 13 mm Length TC
- Ø5.0 x 15 mm Length TC

PrimaConnex® Implants  
Straight\*

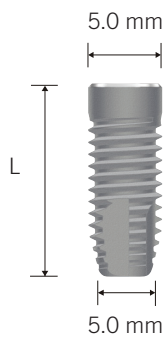

Catalog #

Implant Size

- 15434K**
- 15435K**
- 15436K**
- 15437K**

- Ø5.0 x 8 mm Length
- Ø5.0 x 10 mm Length
- Ø5.0 x 11.5 mm Length
- Ø5.0 x 13 mm Length

- 15634K**
- 15635K**
- 15636K**
- 15637K**

- Ø5.0 x 8 mm Length TC
- Ø5.0 x 10 mm Length TC
- Ø5.0 x 11.5 mm Length TC
- Ø5.0 x 13 mm Length TC

Cover Screw



Catalog #

Description

- 15312K**

- Ø5.0 mm

Healing Abutments



Catalog #

Description

Flare

Cuff Height

- 15313K**
- 15314K**

- Ø5.0 mm
- Ø5.0 mm

- Straight
- Straight

- 3.0 mm
- 5.0 mm

- 15321K**
- 15322K**

- Ø5.0 mm
- Ø5.0 mm

- 5.0 mm
- 5.0 mm

- 3.0 mm
- 5.0 mm

- 15315K**
- 15316K**

- Ø5.0 mm
- Ø5.0 mm

- 6.0 mm
- 6.0 mm

- 3.0 mm
- 5.0 mm

\*All PrimaConnex® implant sizes are available with either a 1.0 mm machined collar or Total Coverage (TC).

The Ø5.0 mm PrimaConnex® can be restored with straight, Ø5.0 and Ø6.0 mm flared prosthetic components. An Abutment Screw is included with all TiLobe abutments.

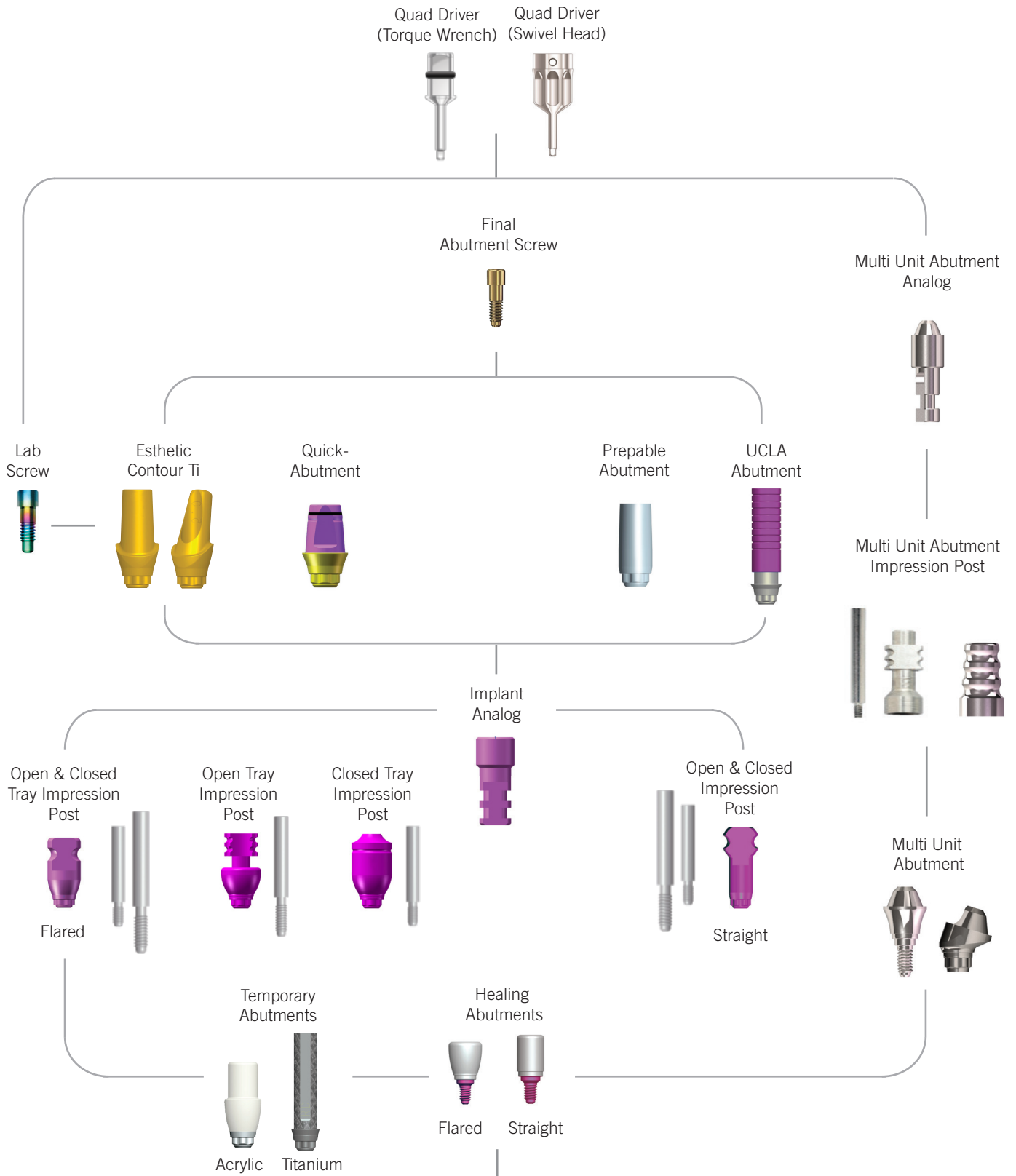

### Open & Closed Tray Impression Post



Catalog #	Description	Flare
<b>45134K</b>	Ø5.0 mm	Straight
<b>45138K</b>	Ø5.0 mm	5.0 mm
<b>45135K</b>	Ø5.0 mm	6.0 mm

### Open Tray Impression Post



Catalog #	Description	Flare
<b>45916K</b>	Ø5.0 mm	7.0 mm
<b>45918K</b>	Ø5.0 mm	8.0 mm

### Closed Tray Impression Post



Catalog #	Description	Flare
<b>45917K</b>	Ø5.0 mm	7.0 mm
<b>45919K</b>	Ø5.0 mm	8.0 mm

### Implant Analog



Catalog #	Description
<b>45142K</b>	Ø5.0 mm, 1-Pack
<b>45145K</b>	Ø5.0 mm, 10-Pack

### Temporary Abutment



Catalog #	Description	Flare
<b>45122K</b>	Ø5.0 mm, Locking	5.0 mm
<b>45123K</b>	Ø5.0 mm, Non-Locking	5.0 mm
<b>45116K</b>	Ø5.0 mm, Locking	6.0 mm

### Ti Temporary Abutment



Catalog #	Description
<b>45079K</b>	Ø5.0 mm, Locking
<b>45080K</b>	Ø5.0 mm, Non-Locking

### Esthetic Contour Ti Abutment

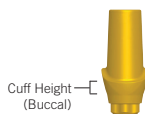

Catalog #	Description	Flare	Cuff Height
<b>45054K</b>	Ø5.0 mm, Straight	5.0 mm	0.5 mm
<b>45055K</b>	Ø5.0 mm, Straight	5.0 mm	1.5 mm
<b>45056K</b>	Ø5.0 mm, 15° Angled	5.0 mm	0.5 mm
<b>45057K</b>	Ø5.0 mm, 15° Angled	5.0 mm	1.5 mm
<b>45038K</b>	Ø5.0 mm, Straight	6.0 mm	1.0 mm
<b>45039K</b>	Ø5.0 mm, Straight	6.0 mm	3.0 mm
<b>45040K</b>	Ø5.0 mm, 15° Angled	6.0 mm	1.0 mm

### UCLA Abutment



Catalog #	Description	Cuff Height
<b>45104K</b>	Gold/Plastic Sleeve, Locking	1.0 mm
<b>45105K</b>	Gold/Plastic Sleeve, Non-Locking	1.0 mm

Replacement  
Final Abutment Screw



Catalog #	Description
45060K	1-Pack

Laboratory Screw



Catalog #	Description
45061K	10-Pack

Quick-Packs



Catalog #	Description	Flare	Cuff Height
45416K	Ø5.0 mm	5.0 mm	0.5 mm
45417K	Ø5.0 mm	5.0 mm	1.5 mm
45418K	Ø5.0 mm	5.0 mm	2.5 mm
45419K	Ø5.0 mm	5.0 mm	4.0 mm
45408K	Ø5.0 mm	6.0 mm	0.5 mm
45409K	Ø5.0 mm	6.0 mm	1.5 mm
45410K	Ø5.0 mm	6.0 mm	2.5 mm
45411K	Ø5.0 mm	6.0 mm	4.0 mm

Quick-Abutment

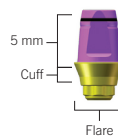

Catalog #	Description	Flare	Cuff Height
45439K	Ø5.0 mm	5.0 mm	0.5 mm
45440K	Ø5.0 mm	5.0 mm	1.5 mm
45441K	Ø5.0 mm	5.0 mm	2.5 mm
45442K	Ø5.0 mm	5.0 mm	4.0 mm
45428K	Ø5.0 mm	6.0 mm	0.5 mm
45429K	Ø5.0 mm	6.0 mm	1.5 mm
45430K	Ø5.0 mm	6.0 mm	2.5 mm
45431K	Ø5.0 mm	6.0 mm	4.0 mm

Quick-Abutment Quick-Cap\*



Catalog #	Description	Flare
45444K	Ø5.0 mm, 1-Pack	5.0 mm
45434K	Ø5.0 mm, 1-Pack	6.0 mm

Quick-Abutment  
Temporary/Healing Cap



Catalog #	Description	Flare
45237K	Ø5.0 mm	5.0 mm
45211K	Ø5.0 mm	6.0 mm

Quick-Abutment Analog



Catalog #	Description	Flare
45449K	Ø5.0 mm	5.0 mm
45447K	Ø5.0 mm	6.0 mm



# Prosthetic Components

## Internal TiLobe®

### Quick-Abutment Plastic Sleeve



Catalog #	Description	Flare
<b>45241K</b>	Ø5.0 mm, Locking	5.0 mm
<b>45243K</b>	Ø5.0 mm, Non-Locking	5.0 mm
<b>45217K</b>	Ø5.0 mm, Locking	6.0 mm
<b>45220K</b>	Ø5.0 mm, Non-Locking	6.0 mm

### Quick-Abutment Ceramic Coping



Catalog #	Description	Flare
<b>45245K</b>	Ø5.0 mm	5.0 mm
<b>45303K</b>	Ø5.0 mm	6.0 mm

### Quick-Abutment Plastic Sleeve Reamer Tool



Catalog #	Description
<b>45311K</b>	Reamer Tool and Centering Pins

### Prepable Abutment



Catalog #	Description
<b>45044K</b>	Ø5.0 mm

### Multi Unit Abutment

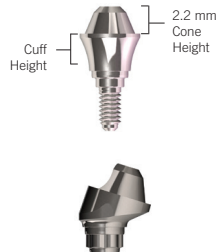

Catalog #	Description	Cuff Height
<b>45319K</b>	Ø5.0 mm, Straight	1.0 mm
<b>45320K</b>	Ø5.0 mm, Straight	2.0 mm
<b>45939K</b>	Ø5.0 mm, Straight	3.0 mm
<b>45940K</b>	Ø5.0 mm, Straight	4.0 mm
<b>45941K</b>	Ø5.0 mm, Angled, 17°	3.0 mm
<b>45942K</b>	Ø5.0 mm, Angled, 17°	4.0 mm
<b>45966K</b>	Ø5.0 mm, Angled, 30°	3.0 mm
<b>45967K</b>	Ø5.0 mm, Angled, 30°	4.0 mm

Multi Unit Abutment  
Healing Cap



Catalog #	Description
<b>45330K</b>	Ø5.0 mm

Multi Unit Abutment  
Impression Post



Catalog #	Description
<b>45327K</b>	Open Tray, Ø5.0 mm with screw
<b>45328K</b>	Closed Tray, Ø5.0 mm

Multi Unit Abutment Analog



Catalog #	Description
<b>45329K</b>	Ø5.0 mm

Multi-Unit Abutment  
Ti Temporary Sleeve



Catalog #	Description
<b>45331K</b>	Ø5.0 mm

Multi Unit Abutment  
Plastic Sleeve



Catalog #	Description
<b>45332K</b>	Ø5.0 mm

Multi Unit Abutment  
Prosthetic Screw



Catalog #	Description
<b>45333K</b>	1-Pack

Angled Multi-Unit Abutment  
Replacement Screw



Catalog #	Description
<b>45334K</b>	1-Pack

**Digital**



Angled Abutment Drivers  
(Latch Type) (Torque Wrench)

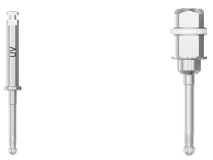

Angulated Screw



Ti-Base



Angulated Screw Channel

Quad Driver (Torque Wrench) Quad Driver (Swivel Head)

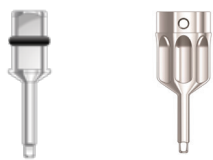

Final Abutment Screw



Ti-Base



Locking Non-Locking

Ti-Blanks



Digital Scanbodies Digital Analog



Download Digital Libraries from Imagine  
**3shape** **exocad**

Temporary Abutments

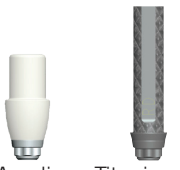

Acrylic Titanium

Healing Abutment



Ø4.1 Shown

Digital Scanbodies



Catalog #

- IM-SBKEP35**
- IM-SBKEP41**
- IM-SBKEP50**

Description

- Mist IC Scanbody 3.5
- Mist IC Scanbody 4.1
- Mist IC Scanbody 5.0

Digital Analog



Catalog #

- IM-3DKEP35**
- IM-3DKEP41**
- IM-3DKEP50**

Description

- Mist IC 3D Analog 3.5
- Mist IC 3D Analog 4.1
- Mist IC 3D Analog 5.0

Tibase (Locking)



Catalog #

- IM-LLKEP35**
- IM-LLKEP41**
- IM-LLKEP50**

Description

- Mist IC L-Link Single 3.5
- Mist IC L-Link Single 4.1
- Mist IC L-Link Single 5.0

Tibase (Non-Locking)



Catalog #

- IM-3DKEP35**
- IM-3DKEP41**
- IM-3DKEP50**

Description

- Mist IC 3D Analog 3.5
- Mist IC 3D Analog 4.1
- Mist IC 3D Analog 5.0

Tibase Angulated Screw Channel



Catalog #

- IM-SLKEP35**
- IM-SLKEP41**
- IM-SLKEP50**

Description

- Mist IC S-Link 3.5
- Mist IC S-Link 4.1
- Mist IC S-Link 5.0

Ti Blanks 10



Catalog #

Description

**IM-PF10KEP35**

Mist IC PreFit10, 3.5

**IM-PF10KEP41**

Mist IC PreFit10, 4.1

**IM-PF10KEP50**

Mist IC PreFit10, 5.0

Ti Blanks 14



Catalog #

Description

**IM-PF14KEP35**

Mist IC PreFit14, 3.5

**IM-PF14KEP41**

Mist IC PreFit14, 4.1

**IM-PF14KEP50**

Mist IC PreFit14, 5.0

Final Abutment Screws

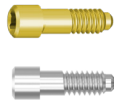

Catalog #

Description

**IM-SCKEP**

Mist IC Screw (Pack of 5)

**IM-SCKEP UV**

Mist IC Angulated Screw (Pack of 5)

Angled Abutment Drivers

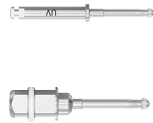

Catalog #

Description

**IM-ALDUVR**

Mist IC Angled Latch Driver Reg (13mm)

**IM-ALDUVL**

Mist IC Angled Latch Driver Long (20mm)

**IM-ASDUVR**

Mist IC Angled Square Driver Reg (13mm)

**IM-ASDUVL**

Mist IC Angled Square Driver Long (20mm)

Quad Drivers



Catalog #

Description

**15272K**

Swivel Head, Short

**15273K**

Swivel Head, Long

**45293K**

Swivel Head, X-Long (35 mm)

**15274K**

Latch Type, Short

**15275K**

Latch Type, Long

**45294K**

Latch Type, X-Long (35 mm)

**15276K**

Torque Wrench, Short

**15277K**

Torque Wrench, Long

Quad Driver (Torque Wrench)    Quad Driver (Swivel Head)

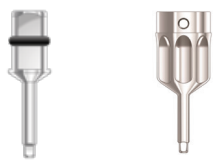

Final Abutment Screw

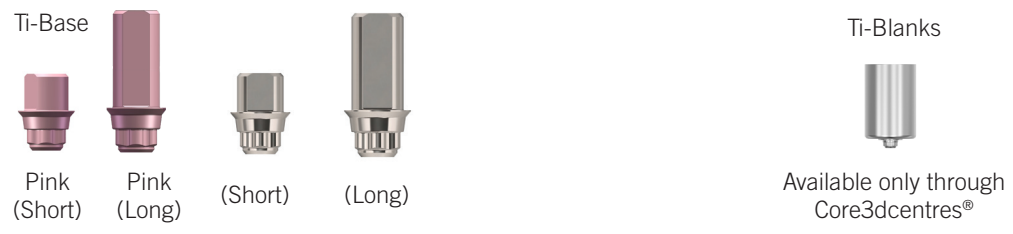

Scan Abutment    Digital Analog



Download Digital Libraries from Core3dcentres®



Temporary Abutments

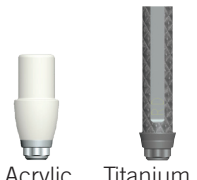

Healing Abutment



Ø4.1 Shown

Scan Abutment



Catalog #

Description

**CORE3D-4802**

Scan Abutment PrimaConnex® ø3.5

**CORE3D-4803**

Scan Abutment PrimaConnex® ø4.1

**CORE3D-4804**

Scan Abutment PrimaConnex® ø5.0

Digital Analog



Catalog #

Description

**CORE3D-3559**

Digital Analog PrimaConnex® ø3.5

**CORE3D-3560**

Digital Analog PrimaConnex® ø4.1

**CORE3D-3561**

Digital Analog PrimaConnex® ø5.0

Ti Base (Short)



Catalog #

Description

**45806K**

Ti Base Insert ø3.5, Short

**45807K**

Ti Base Insert ø4.1, Short

**45808K**

Ti Base Insert ø5.0, Short

Ti Base (Long)



Catalog #

Description

**45901K**

Ti Base Insert ø3.5, Long

**45902K**

Ti Base Insert ø4.1, Long

**45903K**

Ti Base Insert ø5.0, Long

Ti Base Pink (Short)



Catalog #

Description

**45809K**

Ti Base Insert ø3.5, Short

**45810K**

Ti Base Insert ø4.1, Short

**45811K**

Ti Base Insert ø5.0, Short

Ti Base Pink (Long)

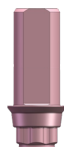

Catalog #

Description

**45812K**

Ti Base Insert ø3.5, Long

**45813K**

Ti Base Insert ø4.1, Long

**45814K**

Ti Base Insert ø5.0, Long

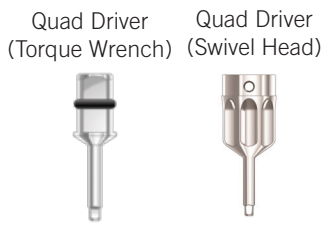

Final Abutment Screw



Esthetic Contour Ti-Base Abutment



Esthetic Contour Ti Digital Impression Post



Healing Abutment



Ø4.1 Shown

Esthetic Contour Ti Digital Impression Post



Catalog #

- 45933K
- 45934K
- 45935K

Description

- Esthetic Contour Ti Digital Impression Post ø3.5
- Esthetic Contour Ti Digital Impression Post ø4.1
- Esthetic Contour Ti Digital Impression Post ø5.0

Esthetic Contour Ti-Base Abutment

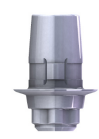

Catalog #

- 45930K
- 45931K
- 45932K

Description

- Esthetic Contour Ti-Base Abutment ø3.5
- Esthetic Contour Ti-Base Abutment ø4.1
- Esthetic Contour Ti-Base Abutment ø5.0

# **LOCATOR<sup>®</sup>** Abutments

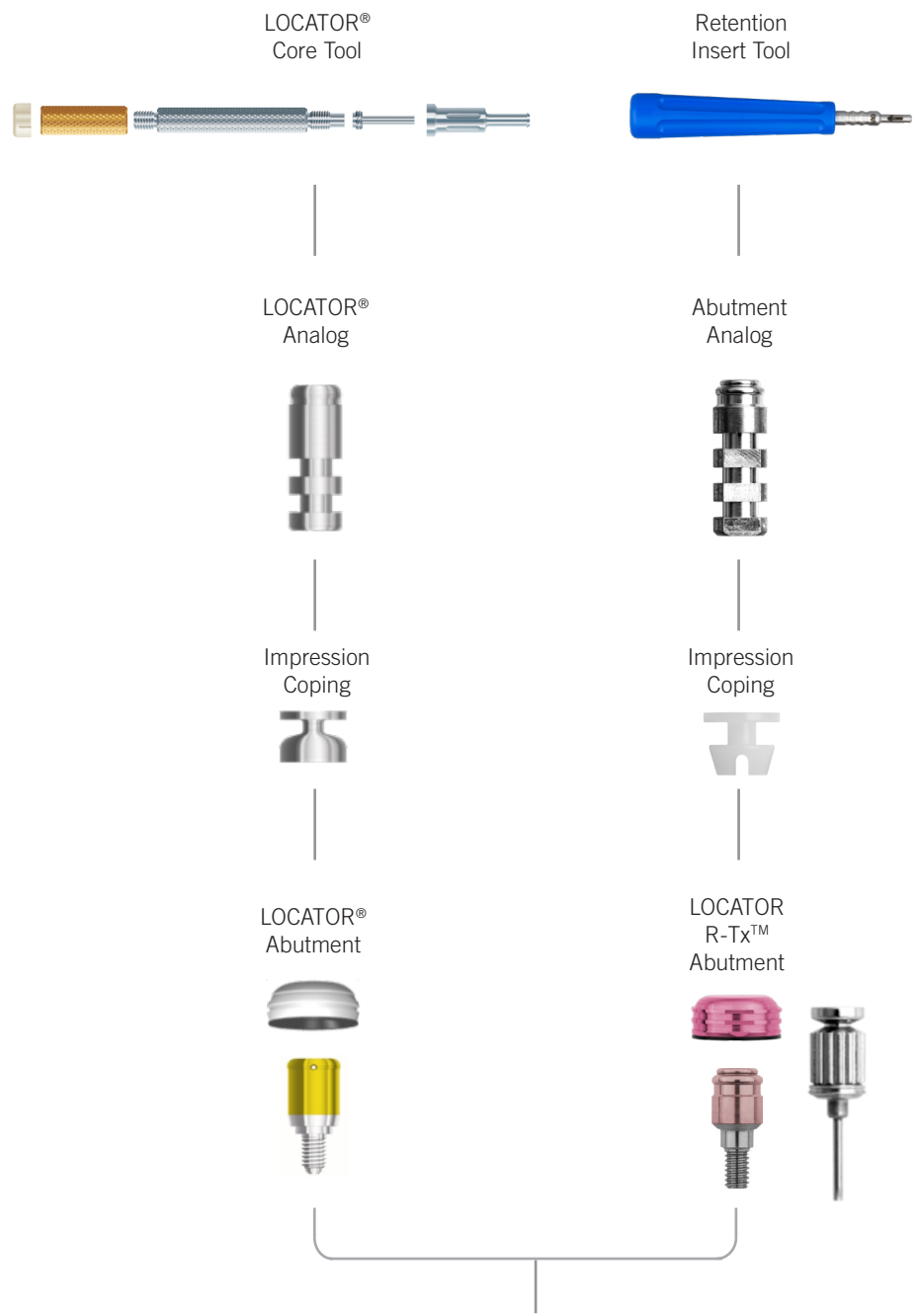



LOCATOR® Abutment Assembly



Catalog #	Description	Cuff Height
<b>45062K</b>	Ø3.5 mm	1.0 mm
<b>45258K</b>	Ø3.5 mm	2.0 mm
<b>45259K</b>	Ø3.5 mm	3.0 mm
<b>45260K</b>	Ø3.5 mm	4.0 mm
<b>45063K</b>	Ø3.5 mm	5.0 mm
<b>45064K</b>	Ø3.5 mm	6.0 mm
<b>45065K</b>	Ø4.1 mm	1.0 mm
<b>45261K</b>	Ø4.1 mm	2.0 mm
<b>45262K</b>	Ø4.1 mm	3.0 mm
<b>45263K</b>	Ø4.1 mm	4.0 mm
<b>45066K</b>	Ø4.1 mm	5.0 mm
<b>45067K</b>	Ø4.1 mm	6.0 mm
<b>45068K</b>	Ø5.0 mm	1.0 mm
<b>45264K</b>	Ø5.0 mm	2.0 mm
<b>45265K</b>	Ø5.0 mm	3.0 mm
<b>45069K</b>	Ø5.0 mm	4.0 mm
<b>45070K</b>	Ø5.0 mm	5.0 mm
<b>45071K</b>	Ø5.0 mm	6.0 mm

LOCATOR® Abutment Accessories



Catalog #	Description
<b>L8519-2</b>	Denture Cap with Black Processing Male, 2-Pack Clear, Pink, Blue Retention, Block out spacers
<b>45266K</b>	LOCATOR® Replacement Male, Clear, Standard Retention, 4-Pack
<b>45267K</b>	LOCATOR® Replacement Male, Pink, Light Retention, 4-Pack
<b>45268K</b>	LOCATOR® Replacement Male, Blue, (ELR) Extra Light Retention, 4-Pack
<b>45269K</b>	LOCATOR® Replacement Male, Green, (ER) Extended Range, 4-Pack
<b>45270K</b>	LOCATOR® Female Analog, 4-Pack
<b>45271K</b>	LOCATOR® Impression Coping, 4-Pack
<b>45273K</b>	LOCATOR® Core Tool
<b>45274K</b>	LOCATOR® Torque Wrench Driver

LOCATOR R-Tx™  
Abutment



Catalog #	Description	Cuff Height
<b>LOCR-TX 31200-01</b>	Ø3.5 mm	1.0 mm
<b>LOCR-TX 31200-02</b>	Ø3.5 mm	2.0 mm
<b>LOCR-TX 31200-03</b>	Ø3.5 mm	3.0 mm
<b>LOCR-TX 31200-04</b>	Ø3.5 mm	4.0 mm
<b>LOCR-TX 31200-05</b>	Ø3.5 mm	5.0 mm
<b>LOCR-TX 31200-06</b>	Ø3.5 mm	6.0 mm
<b>LOCR-TX 31201-01</b>	Ø4.1 mm	1.0 mm
<b>LOCR-TX 31201-02</b>	Ø4.1 mm	2.0 mm
<b>LOCR-TX 31201-03</b>	Ø4.1 mm	3.0 mm
<b>LOCR-TX 31201-04</b>	Ø4.1 mm	4.0 mm
<b>LOCR-TX 31201-05</b>	Ø4.1 mm	5.0 mm
<b>LOCR-TX 31201-06</b>	Ø4.1 mm	6.0 mm
<b>LOCR-TX 31202-01</b>	Ø5.0 mm	1.0 mm
<b>LOCR-TX 31202-02</b>	Ø5.0 mm	2.0 mm
<b>LOCR-TX 31202-03</b>	Ø5.0 mm	3.0 mm
<b>LOCR-TX 31202-04</b>	Ø5.0 mm	4.0 mm
<b>LOCR-TX 31202-05</b>	Ø5.0 mm	5.0 mm
<b>LOCR-TX 31202-06</b>	Ø5.0 mm	6.0 mm

LOCATOR R-Tx™  
Abutment Accessories



Catalog #	Description
<b>LOCR-TX 30013-01</b>	Denture Attachment Processing Assembly, 4-Pack
<b>LOCR-TX 30001-01</b>	Zero Retention Insert, 4-Pack
<b>LOCR-TX 30002-01</b>	Low Retention Insert, 4-Pack
<b>LOCR-TX 30003-01</b>	Medium Retention Insert, 4-Pack
<b>LOCR-TX 30004-01</b>	High Retention Insert, 4-Pack
<b>LOCR-TX 30014-01</b>	3.35 mm Abutment Analog, 4-Pack
<b>LOCR-TX 30015-01</b>	4.0 mm Abutment Analog, 4-Pack
<b>LOCR-TX 30016-01</b>	5.0 mm Abutment Analog, 4-Pack
<b>LOCR-TX 30017-01</b>	Impression Coping, 4-Pack
<b>LOCR-TX 30021-01</b>	Retention Insert Tool
<b>LOCR-TX 04936</b>	.050"/1.25 mm Hex, Torque Wrench
<b>LOCR-TX 08007</b>	.050"/1.25 mm Hex Driver with Thumb Knob
<b>LOCR-TX 08008</b>	.050"/1.25 mm Hex, Latch Lock Driver
<b>LOCR-TX 30012-01</b>	Processing Insert, 4-Pack
<b>LOCR-TX 30018-01</b>	Processing Spacer, 4-Pack

**LOCATOR F-Tx®  
Abutment**



Catalog #	Description	Cuff Height
<b>LOCF-TX 11200-01</b>	Ø3.5 mm	1.0 mm
<b>LOCF-TX 11200-02</b>	Ø3.5 mm	2.0 mm
<b>LOCF-TX 11200-03</b>	Ø3.5 mm	3.0 mm
<b>LOCF-TX 11200-04</b>	Ø3.5 mm	4.0 mm
<b>LOCF-TX 11200-05</b>	Ø3.5 mm	5.0 mm
<b>LOCF-TX 11201-01</b>	Ø4.1 mm	1.0 mm
<b>LOCF-TX 11201-02</b>	Ø4.1 mm	2.0 mm
<b>LOCF-TX 11201-03</b>	Ø4.1 mm	3.0 mm
<b>LOCF-TX 11201-04</b>	Ø4.1 mm	4.0 mm
<b>LOCF-TX 11201-05</b>	Ø4.1 mm	5.0 mm
<b>LOCF-TX 11202-01</b>	Ø5.0 mm	1.0 mm
<b>LOCF-TX 11202-02</b>	Ø5.0 mm	2.0 mm
<b>LOCF-TX 11202-03</b>	Ø5.0 mm	3.0 mm
<b>LOCF-TX 11202-04</b>	Ø5.0 mm	4.0 mm
<b>LOCF-TX 11202-05</b>	Ø5.0 mm	5.0 mm

**LOCATOR F -Tx™  
Abutment Accessories**



Catalog #	Description
<b>LOCF-TX 10028-01</b>	Manual Driver
<b>LOCF-TX 10029-01</b>	Latch Driver
<b>LOCF-TX 10030-01</b>	Processing Cap, 2Pk
<b>LOCF-TX 10032-01</b>	Processing Ball, 2Pk
<b>LOCF-TX 10033-01</b>	Low Retention Ball, 2Pk
<b>LOCF-TX 10034-01</b>	Medium Retention Ball, 2Pk
<b>LOCF-TX 10035-01</b>	High Retention Ball, 2 Pk
<b>LOCF-TX 10036-01</b>	Healing Cap, 2Pk
<b>LOCF-TX 10037-01</b>	Abutment Analog, 2Pk
<b>LOCF-TX 10039-01</b>	Polishing Cap, 2Pk
<b>LOCF-TX 10040-01</b>	Waxing Cap, 2Pk
<b>LOCF-TX 10041-01</b>	Denture Attachment Housing, 2Pk
<b>LOCF-TX 10042-01</b>	Retention Ball Hex Driver
<b>LOCF-TX 10043-01</b>	Impression Coping, 2Pk
<b>LOCF-TX 10094</b>	Tip Wrench
<b>LOCF-TX 10095</b>	Seating Tip
<b>LOCF-TX 10096</b>	Removal Tip with Threaded Adapter
<b>LOCF-TX 10097</b>	Replacement Wire
<b>LOCF-TX 10098</b>	Threaded Adapter
<b>LOCF-TX 10099</b>	Wire and Lever Wrench
<b>LOCF-TX 100100</b>	Seating and Removal Tool



**PrimaSolo®**

Implant Analog



Temporary/Healing Cap



Ø3.0 Implant





PrimaSolo® Implants  
Tapered\*

Ø3.0 mm



2.3 mm

Catalog #

**15400K**

**15401K**

Implant Size

Ø3.0 x 13 mm Length

Ø3.0 x 15 mm Length

Temporary/Healing Cap



Catalog #

**45000K**

Description

Ø3.0 mm

Implant Analog



Catalog #

**45172K**

Description

Ø3.0 mm

\*PrimaSolo® One-Piece Implants consist of a threaded, tapered implant and integrated gold-colored abutment, placed in a single-stage procedure.

Angle correction up to 10° for Ø3.0 PrimaSolo® Implants; up to 15° for Ø3.5, Ø4.1, and Ø5.0 PrimaSolo® Implants.

Implant Analog



Temporary/Healing Cap



Ø3.5 Implant





# PrimaSolo® Implants

One-Piece

### PrimaSolo® Implants Tapered\*



#### Catalog #

- 15402K**
- 15403K**
- 15404K**
- 15405K**

#### Implant Size

- Ø3.5 x 10 mm Length
- Ø3.5 x 11.5 mm Length
- Ø3.5 x 13 mm Length
- Ø3.5 x 15 mm Length

### Temporary/Healing Cap



#### Catalog #

- 45001K**

#### Description

- Ø3.5 mm

### Implant Analog



#### Catalog #

- 45173K**

#### Description

- Ø3.5 mm

\*PrimaSolo® One-Piece Implants consist of a threaded, tapered implant and integrated gold-colored abutment, placed in a single-stage procedure.

Angle correction up to 15° for Ø3.5, Ø4.1, and Ø5.0 PrimaSolo® Implants.



Implant Analog



Temporary/Healing Cap



Ø4.1 Implant



PrimaSolo® Implants  
Tapered\*

Ø4.1 mm



2.7 mm

Catalog #

Implant Size

**15406K**

Ø4.1 x 10 mm Length

**15407K**

Ø4.1 x 11.5 mm Length

**15408K**

Ø4.1 x 13 mm Length

**15409K**

Ø4.1 x 15 mm Length

Temporary/Healing Cap



Catalog #

Description

**45002K**

Ø4.1 mm

Implant Analog



Catalog #

Description

**45174K**

Ø4.1 mm

\*PrimaSolo® One-Piece Implants consist of a threaded, tapered implant and integrated gold-colored abutment, placed in a single-stage procedure.

Angle correction up to 15° for Ø3.5, Ø4.1, and Ø5.0 PrimaSolo® Implants.

Implant Analog



Temporary/Healing Cap



Ø5.0 Implant

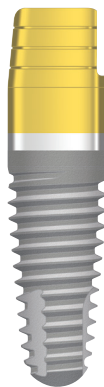



## PrimaSolo® Implants

One-Piece

### PrimaSolo® Implants Tapered\*



#### Catalog #

**15410K**

**15411K**

**15412K**

#### Implant Size

Ø5.0 x 10 mm Length

Ø5.0 x 11.5 mm Length

Ø5.0 x 13 mm Length

### Temporary/Healing Cap



#### Catalog #

**45003K**

#### Description

Ø5.0 mm

### Implant Analog



#### Catalog #

**45175K**

#### Description

Ø5.0 mm

\*PrimaSolo® One-Piece Implants consist of a threaded, tapered implant and integrated gold-colored abutment, placed in a single-stage procedure.

Angle correction up to 15° for Ø3.5, Ø4.1, and Ø5.0 PrimaSolo® Implants.

# **Surgical Kits** & Instruments

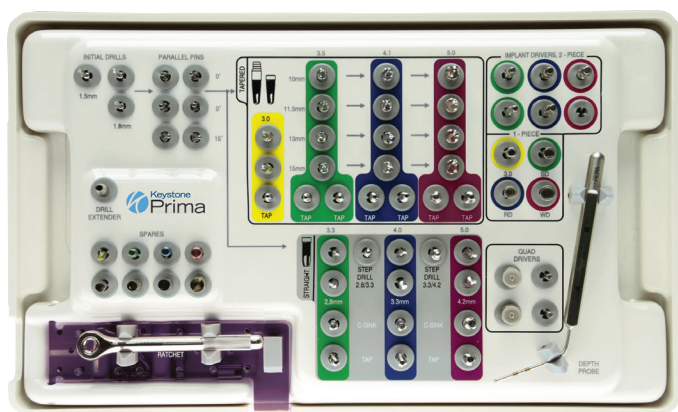

Catalog # Surgical Options

<b>15278K</b>	Surgical Cassette (empty)
<b>15241K</b>	<b>A.</b> PrimaConnex® Surgical Kit
<b>15244K</b>	<b>B.</b> PrimaConnex® Tapered Drill and Tap Set
<b>15249K</b>	<b>C.</b> PrimaConnex® Straight Drill and Tap Set

The PrimaConnex® Surgical Kit contains all instrumentation except the final tapered and/or straight drills and taps. The Tapered and/or Straight Drill and Tap Set(s) must be ordered separately, depending on the implant design to be placed.

Catalog #	Description
<b>15241K</b>	<b>A.</b> PrimaConnex® Surgical Kit Includes:
<b>15278K</b>	Surgical Cassette
<b>15200K</b>	1.5 x 15 mm Initial Drill
<b>15201K</b>	1.8 x 11.5 mm Initial Drill
<b>15202K</b>	1.8 x 15 mm Initial Drill
<b>15225K</b>	Depth Probe
<b>L1404-01K</b>	Drill Extender
<b>15286K</b>	3.5 Implant Driver, TiLobe Connection, Short
<b>15287K</b>	3.5 Implant Driver, TiLobe Connection, Long
<b>15288K</b>	4.1 Implant Driver, TiLobe Connection, Short
<b>15289K</b>	4.1 Implant Driver, TiLobe Connection, Long
<b>15290K</b>	5.0 Implant Driver, TiLobe Connection, Short
<b>15282K</b>	3.5 Implant Driver, PrimaConnex®, Ratchet
<b>15283K</b>	4.1 Implant Driver, PrimaConnex®, Ratchet
<b>15284K</b>	5.0 Implant Driver, PrimaConnex®, Ratchet

Catalog #	Description
<b>L1800-22-02K</b>	Irrigation Port Cleaner
<b>15226K</b>	Parallel Pins, Straight, 1.5 mm/1.8 mm, 2-Pack
<b>45045K</b>	Parallel Pins, 15° Angled, 1.5 mm/1.8 mm, 2-Pack
<b>15274K</b>	Quad Driver, Latch, Short
<b>15275K</b>	Quad Driver, Latch, Long
<b>15272K</b>	Quad Driver, Swivel, Short
<b>15273K</b>	Quad Driver, Swivel, Long
<b>15224K</b>	Ratchet Adapter
<b>L1702-01K</b>	Surgical Ratchet
<b>L1407K</b>	Conversion Handle, Latch
<b>4409-0255</b>	PrimaConnex® Surgical Manual
<b>15240K</b>	Implant Sizing Overlays
<b>4409-0257</b>	Wall Chart
<b>4409-0258</b>	Drill Usage Chart

Catalog #	Description
<b>15244K</b>	<b>B. PrimaConnex® Tapered Drill and Tap Set</b> Includes:
<b>15205K</b>	3.5 x 10 mm Final Tapered Drill
<b>15206K</b>	3.5 x 11.5 mm Final Tapered Drill
<b>15207K</b>	3.5 x 13 mm Final Tapered Drill
<b>15208K</b>	3.5 x 15 mm Final Tapered Drill
<b>15209K</b>	4.1 x 10 mm Final Tapered Drill
<b>15210K</b>	4.1 x 11.5 mm Final Tapered Drill
<b>15211K</b>	4.1 x 13 mm Final Tapered Drill
<b>15212K</b>	4.1 x 15 mm Final Tapered Drill
<b>15213K</b>	5.0 x 10 mm Final Tapered Drill
<b>15214K</b>	5.0 x 11.5 mm Final Tapered Drill
<b>15215K</b>	5.0 x 13 mm Final Tapered Drill
<b>15075K</b>	5.0 x 15 mm Final Tapered Drill
<b>15217K</b>	3.5 x 10/11.5 mm Tapered Surgical Tap
<b>15247K</b>	3.5 x 13/15 mm Tapered Surgical Tap
<b>15218K</b>	4.1 x 10/11.5 mm Tapered Surgical Tap
<b>15248K</b>	4.1 x 13/15 mm Tapered Surgical Tap
<b>15219K</b>	5.0 x 10/11.5 mm Tapered Surgical Tap
<b>15076K</b>	5.0 x 13/15 mm Tapered Surgical Tap

Catalog #	Description
<b>15249K</b>	<b>C. PrimaConnex® Straight Drill and Tap Set</b> Includes:
<b>15250K</b>	2.8 mm x 11.5 mm Straight Drill
<b>15251K</b>	2.8 mm x 15 mm Straight Drill
<b>15252K</b>	3.3 mm x 11.5 mm Straight Drill
<b>15253K</b>	3.3 mm x 15 mm Straight Drill
<b>15254K</b>	4.2 mm x 11.5 mm Straight Drill
<b>15255K</b>	4.2 mm x 13 mm Straight Drill
<b>15101K</b>	1.8 mm/2.8 mm Step Drill
<b>15256K</b>	2.8 mm/3.3 mm Step Drill
<b>15257K</b>	3.3 mm/4.2 mm Step Drill
<b>15258K</b>	3.3 mm Countersink Drill
<b>15259K</b>	4.0 mm Countersink Drill
<b>15260K</b>	5.0 mm Countersink Drill
<b>15262K</b>	3.3 x 15 mm Straight Surgical Tap
<b>15264K</b>	4.0 x 15 mm Straight Surgical Tap
<b>15265K</b>	5.0 x 13 mm Straight Surgical Tap

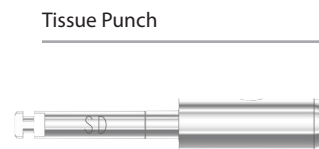

Catalog #	Description
<b>15236K</b>	Ø3.0 mm Tissue Punch with Guide Pin
<b>15237K</b>	Ø3.5 mm, with Guide Pin
<b>15238K</b>	Ø4.1 mm, with Guide Pin
<b>15239K</b>	Ø5.0 mm, with Guide Pin



Catalog #	Description
<b>L1405-23-00K</b>	Ø2.3 mm

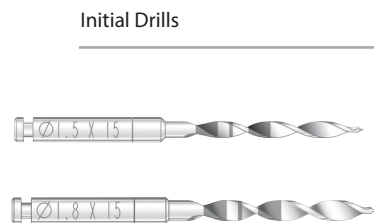

Catalog #	Description
<b>15200K</b>	Ø1.5 x 15 mm, Non-Irrigated
<b>15201K</b>	Ø1.8 x 11.5 mm, Non-Irrigated
<b>15202K</b>	Ø1.8 x 15 mm, Non-Irrigated



Parallel Pins

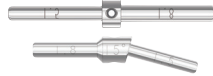

Catalog #

Description

**15226K**  
**45045K**

Ø1.5/1.8 mm, Straight, 2-Pack  
Ø1.5/1.8 mm, 15°, 2-Pack

Final Tapered Drills



Catalog #

Description

**15203K**  
**15204K**

Ø3.0 x 13 mm  
Ø3.0 x 15 mm

**15205K**  
**15206K**  
**15207K**  
**15208K**

Ø3.5 x 10 mm  
Ø3.5 x 11.5 mm  
Ø3.5 x 13 mm  
Ø3.5 x 15 mm

**15209K**  
**15210K**  
**15211K**  
**15212K**

Ø4.1 x 10 mm  
Ø4.1 x 11.5 mm  
Ø4.1 x 13 mm  
Ø4.1 x 15 mm

**15213K**  
**15214K**  
**15215K**  
**15075K**

Ø5.0 x 10 mm  
Ø5.0 x 11.5 mm  
Ø5.0 x 13 mm  
Ø5.0 x 15 mm

Removable Drill Stop  
for Tapered Drills



Catalog #

Description

**15220K**  
**15221K**  
**15222K**  
**15223K**

3.0 mm  
3.5 mm  
4.1 mm  
5.0 mm

Tapered Surgical Taps



Catalog #

Description

**15217K**  
**15247K**

Ø3.5 x 10/11.5 mm  
Ø3.5 x 13/15 mm

**15218K**  
**15248K**







Ø4.1 x 10/11.5 mm  
Ø4.1 x 13/15 mm

**15219K**  
**15076K**

Ø5.0 x 10/11.5 mm  
Ø5.0 x 13/15 mm

Only PrimaConnex® Initial Drills are non-irrigated. All other Prima Tapered Drills, Tapered Taps, Straight Drills, Step Drills, Countersink Drills and Straight Taps are irrigated.



Straight Drills	Catalog #	Description
	<b>15250K</b>	Ø2.8 x 11.5 mm
	<b>15251K</b>	Ø2.8 x 15 mm
	<b>15252K</b>	Ø3.3 x 11.5 mm
	<b>15253K</b>	Ø3.3 x 15 mm
	<b>15254K</b>	Ø4.2 x 11.5 mm
	<b>15255K</b>	Ø4.2 x 13 mm
Step Drills for Straight Implants	Catalog #	Description
	<b>15101K</b>	Ø1.8/Ø2.8 mm
	<b>15256K</b>	Ø2.8/Ø3.3 mm
	<b>15257K</b>	Ø3.3/Ø4.2 mm
	Countersink Drills for Straight Implants	Catalog #
	<b>15258K</b>	For Ø3.3 mm Straight Implants
	<b>15259K</b>	For Ø4.0 mm Straight Implants
	<b>15260K</b>	For Ø5.0 mm Straight Implants
Straight Surgical Taps	Catalog #	Description
	<b>15261K</b>	Ø3.3 x 11.5 mm
	<b>15262K</b>	Ø3.3 x 15 mm
	<b>15263K</b>	Ø4.0 x 11.5 mm
	<b>15264K</b>	Ø4.0 x 15 mm
	<b>15265K</b>	Ø5.0 x 13 mm
Drill Extender	Catalog #	
	<b>L1404-01K</b>	
Bone Profiler	Catalog #	Description
	<b>15279K</b>	Ø3.5 mm, with Guide Pin
	<b>15280K</b>	Ø4.1 mm, with Guide Pin
	<b>15281K</b>	Ø5.0 mm, with Guide Pin

Only PrimaConnex® Initial Drills are non-irrigated. All other Prima Tapered Drills, Tapered Taps, Straight Drills, Step Drills, Countersink Drills and Straight Taps are irrigated.



PrimaConnex®  
Implant Driver, Ratchet



Catalog #	Description
15282K	Ø3.5 mm
15283K	Ø4.1 mm
15284K	Ø5.0 mm

PrimaConnex®  
Implant Driver, Latch



Catalog #	Description	Length
15286K	Ø3.5 mm Implant Driver, Short	16 mm
15287K	Ø3.5 mm Implant Driver, Long	21 mm
15288K	Ø4.1 mm Implant Driver, Short	16 mm
15289K	Ø4.1 mm Implant Driver, Long	21 mm
15290K	Ø5.0 mm Implant Driver, Short	16 mm
G21295	Ø5.0 mm Implant Driver, Long	21 mm

PrimaSolo®  
Implant Drivers



Catalog #	Description
15227K	Ø3.0 mm, Implant Driver
15228K	Ø3.5 mm, Implant Driver
15229K	Ø4.1 mm, Implant Driver
15230K	Ø5.0 mm, Implant Driver

Surgical Ratchet



Catalog #	Description
L1702-01K	Surgical Ratchet

Surgical Ratchet/  
Torque Wrench



Catalog #	Description
K15695	Surgical Ratchet/Torque Wrench

Quad Drivers

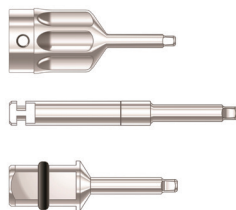

Catalog #	Description
15272K	Swivel Head, Short
15273K	Swivel Head, Long
45293K	Swivel Head, X-Long (35 mm)
15274K	Latch Type, Short
15275K	Latch Type, Long
45294K	Latch Type, X-Long (35 mm)
15276K	Torque Wrench, Short
15277K	Torque Wrench, Long

Ratchet Adapter

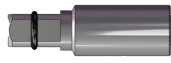

Catalog #  
**15224K**

Directional Indicators



Catalog #  
**45041K**

Description  
Try-In Set

Conversion Handles

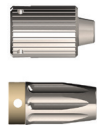

Catalog #  
**L1407K**  
**ISS1112K**

Description  
Conversion Handle, Latch Type  
Conversion Handle, Square Type

Surgical Hand Driver

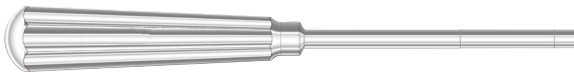

Catalog #  
**15271K**

Depth Probe



Catalog #  
**15225K**

Irrigation Port Cleaner



Catalog #  
**L1800-22-02K**

Osteotomes

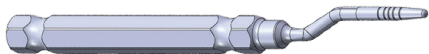

Catalog #  
**15063K**  
**15067K**  
**15068K**  
**15069K**  
**15070K**

Description  
Osteotome Kit, Round, with Tray  
1.8-2.5 mm, Round, Condensing  
1.9-3.0 mm, Round, Condensing  
2.2-3.6 mm, Round, Condensing  
2.8-4.5 mm, Round, Condensing

**15064K**  
**15071K**  
**15072K**  
**15073K**  
**15074K**

Osteotome Kit, Sinus, with Tray  
1.8-2.5 mm, Concave, Sinus  
1.9-3.0 mm, Concave, Sinus  
2.2-3.6 mm, Concave, Sinus  
2.8-4.5 mm, Concave, Sinus

**15066K**

Osteotome Tray (empty)



## Surgical Kit Overview

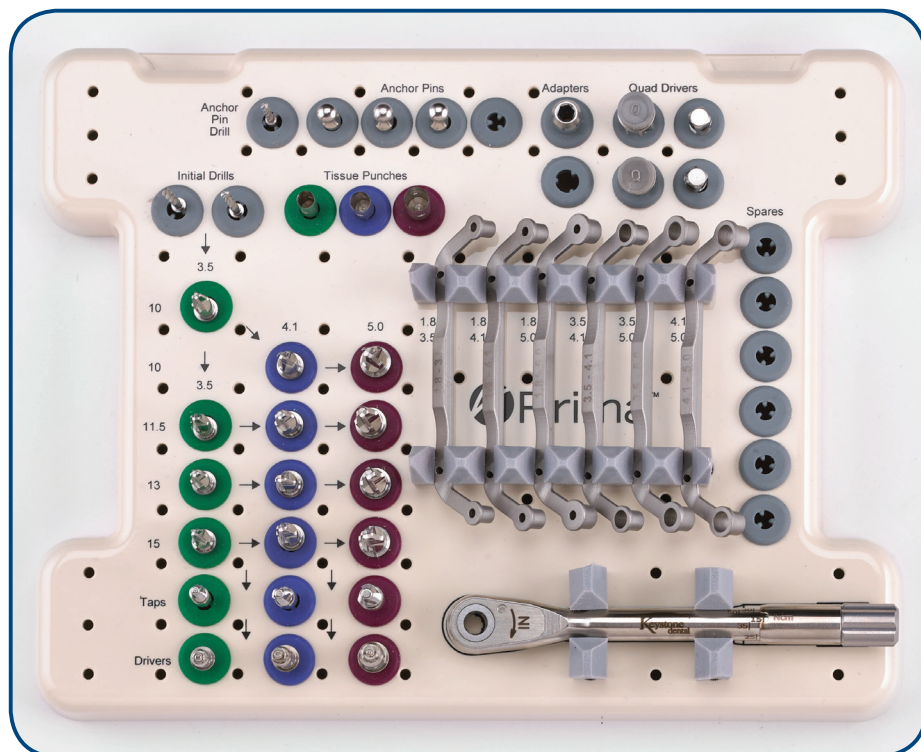

Catalog #	Description
15651K	Tapered PrimaConnex® Guided Surgery Kit (with instruments) Includes the instrumentation required to place PrimaConnex® Tapered Implants
15650K	Guided Surgery Cassette (without instruments)



Anchor Pins & Anchor Pin Drill



Catalog #

Description

**E40100**  
**E20101**

Anchor Pins (package of 3)  
Anchor Pin Drill Ø1.6 mm

Tissue Punch

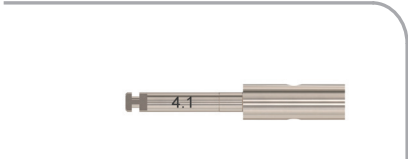

Catalog #

Description

**15671K**  
**15672K**  
**15673K**

PrimaConnex® Guided Tissue Punch, Ø3.5  
PrimaConnex® Guided Tissue Punch, Ø4.1  
PrimaConnex® Guided Tissue Punch, Ø5.0

Guided Surgery Drills



Catalog #

Description

**15674K**  
**15675K**

PrimaConnex® Guided Initial Drill, Short  
PrimaConnex® Guided Initial Drill, Long

**15652K**  
**15653K**  
**15654K**  
**15655K**

PrimaConnex® Guided Surgery, Tapered Drill, Ø3.5 x 10  
PrimaConnex® Guided Surgery, Tapered Drill, Ø3.5 x 11.5  
PrimaConnex® Guided Surgery, Tapered Drill, Ø3.5 x 13  
PrimaConnex® Guided Surgery, Tapered Drill, Ø3.5 x 15

**15656K**  
**15657K**  
**15658K**  
**15659K**

PrimaConnex® Guided Surgery, Tapered Drill, Ø4.1 x 10  
PrimaConnex® Guided Surgery, Tapered Drill, Ø4.1 x 11.5  
PrimaConnex® Guided Surgery, Tapered Drill, Ø4.1 x 13  
PrimaConnex® Guided Surgery, Tapered Drill, Ø4.1 x 15

**15660K**  
**15661K**  
**15662K**  
**15663K**

PrimaConnex® Guided Surgery, Tapered Drill, Ø5.0 x 10  
PrimaConnex® Guided Surgery, Tapered Drill, Ø5.0 x 11.5  
PrimaConnex® Guided Surgery, Tapered Drill, Ø5.0 x 13  
PrimaConnex® Guided Surgery, Tapered Drill, Ø5.0 x 15



Drill Guides



Catalog #

Description

- 15676K
- 15678K
- 15679K
  
- 15680K
- 15681K
- 15682K

- PrimaConnex® Guided Drill Guide, Initial Drill, Ø3.5
- PrimaConnex® Guided Drill Guide, Initial Drill, Ø4.1
- PrimaConnex® Guided Drill Guide, Initial Drill, Ø5.0
  
- PrimaConnex® Guided Drill Guide, Ø3.5/Ø4.1
- PrimaConnex® Guided Drill Guide, Ø3.5/Ø5.0
- PrimaConnex® Guided Drill Guide, Ø4.1/Ø5.0

Guided Surgery Bone Taps

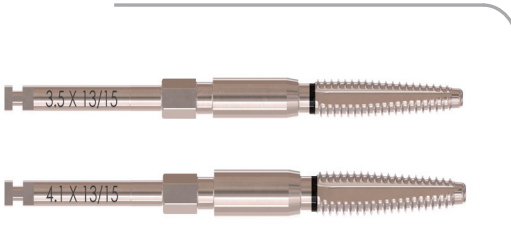

Catalog #

Description

- 15664K
- 15665K
- 15667K
- 15668K
- 15669K
- 15670K

- PrimaConnex® Guided Bone Tap, Ø3.5, Short
- PrimaConnex® Guided Bone Tap, Ø3.5, Long
- PrimaConnex® Guided Bone Tap, Ø4.1, Short
- PrimaConnex® Guided Bone Tap, Ø4.1, Long
- PrimaConnex® Guided Bone Tap, Ø5.0, Short
- PrimaConnex® Guided Bone Tap, Ø5.0, Long

Guided Implant Drivers

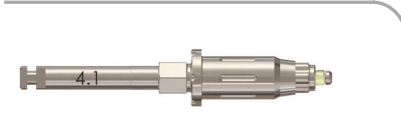

Catalog #

Description

- 15683K
- 15684K
- 15685K

- PrimaConnex® Guided Implant Driver, Ø3.5
- PrimaConnex® Guided Implant Driver, Ø4.1
- PrimaConnex® Guided Implant Driver, Ø5.0

Surgical Ratchet & Ratchet Adapter



Catalog #

Description

- K15695
- 15686K

- Surgical Ratchet/Torque Wrench
- Ratchet Adapter

Quad Drivers

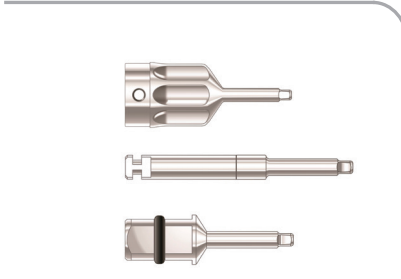

- 15272K
- 15273K
- 45293K
  
- 15274K
- 15275K
- 45294K
  
- 15276K
- 15277K

- Swivel Head, Short
- Swivel Head, Long
- Swivel Head, X-Long (35 mm)
  
- Latch Type, Short
- Latch Type, Long
- Latch Type, X-Long (35 mm)
  
- Torque Wrench, Short
- Torque Wrench, Long

# **Surgical Motors & Accessories**



### Implantmed Surgical Motors



Catalog #	Description
<b>WH-90000207</b>	SI-1015 Implantmed Base Motor Unit
<b>WH-90000213</b>	SI-1015 Implantmed Motor Unit Fully Loaded
<b>WH-90000208</b>	SI-1015 Implantmed Base Unit with Osstell
<b>WH-90000209</b>	SI-1015 Implantmed Motor Unit, WiFi Footpedal Upgrade
<b>WH-90000210</b>	SI-1015 Implantmed Motor Unit, WiFi Footpedal Upgrade & Osstell
<b>WH-90000211</b>	SI-1015 Implantmed Motor Unit, LED+ Motor Upgrade & Osstell
<b>WH-90000212</b>	SI-1015 Implantmed Motor Unit, LED + Motor Upgrade
<b>WH-90000214</b>	SI-1015 Implantmed Motor Unit Fully Loaded & Osstell

### Implantmed Classic Motor



Catalog #	Description
<b>WH-90000270</b>	Implanted Classic + WI-75 E/EM Handpiece non LED
<b>WH-90000271</b>	Implanted Classic + W5-75 LG Handpiece LED





### Piezomed Surgical Unit & Accessories



Catalog #	Description
<b>WH-06985000</b>	Piezomed handpiece 1.8m
<b>WH-07004400</b>	Foot Pedal Piezomed
<b>WH-07159200</b>	Piezomed handpiece 3.5m
<b>WH-30078000</b>	Piezomed SA-320 1.8m
<b>WH-30078001</b>	Piezomed SA-320 3.5m
<b>WH-07173200</b>	Instrument Set Special
<b>WH-07997090</b>	Instrument Kit Crestal A
<b>WH-07173500</b>	Instrument Kit EX
<b>WH-07022500</b>	B6 Tip
<b>WH-07022600</b>	B7 Tip

### Implantmed Surgical Handpieces



Catalog #	Description
<b>WH-30058000</b>	S-11 1:1 Straight (For Implantmed SI-1015 LC motor only)
<b>WH-30033000</b>	WS-75 L 20:1, Contra-angle (For Implantmed SI-1015 LC motor only)
<b>WH-30065000</b>	WS-75 Contra-Angle 20:1 Dismantlable Handpiece for implant surgery (10-2,000 rpm)
<b>WH-30032000</b>	WS-75 L G Contra-Angle 20:1 Dismantlable Handpiece with Mini LED + for implant surgery (10-2,000 rpm)
<b>WH-90000210</b>	SI-1015 Implantmed Motor Unit, WiFi Footpedal Upgrade
<b>WH-90000211</b>	SI-1015 Implantmed Motor Unit, LED+ Motor Upgrade



Implantmed Surgical Motor & Accessories\*



Catalog #	Description
<b>WH-04363600</b>	Irrigation Tubing and Spike Assembly, 6-Pack, Disposable (for use with Implantmed series & Elcomed SA-310 motors)
<b>WH-00929300</b>	Irrigation Tubing with Luer Lock, Green (10-Pack)
<b>WH-04019000</b>	Irrigation Tubing Clips, 5-Pack (for use with Implantmed SI-310 motors to hold tubing to motor cable)
<b>WH-02610500</b>	Irrigation Needle/Canula (for use with internally irrigated drills)
<b>WH-06016400</b>	Y-Connector Complete
<b>WH-06946300</b>	Irrigation Spray Clip (new series), Right Side, E/KM, Green (3-Pack)
<b>WH-06946400</b>	Irrigation Spray Clip (new series), Light Side, Green (3-Pack)
<b>WH-06946500</b>	Irrigation Spray Clip (new series), Right Side, Green (3-Pack)
<b>WH-04757100</b>	Irrigation Spray Clip (new series), Left Side, E/KM, Black (3-Pack)
<b>WH-05051000</b>	Irrigation Spray Clip (old series), Black (3-Pack)
<b>WH-02139800</b>	Bur testing Gauge (to check all 2.35 mm & 1.6 mm burs)
<b>WH-10940011</b>	W&H F-1 Service Oil, 400ml (Special shipping & handling [aerosol can] Contact Customer Service for shipping rates.)
<b>WH-02038200</b>	Spray Cap for Service Oil (resuable replacement)
<b>WH-04013500</b>	Sterilization Case
<b>WH-30264001</b>	S-NW + SPI WiFi Foot Pedal (for Elcomed SA-310 & Implantmed SI-915 white only)
<b>WH-30264000</b>	S-NW + CAN WiFi Foot Pedal (For Implantmed SI-1015 only)
<b>WH-30210000</b>	Osstell ISQ Module (For Implantmed SI-1015 only)
<b>WH-30185000</b>	EM-19 Motor, 1.8m Cable, without LED + Port (For Implantmed SI-1015 only)
<b>WH-30281000</b>	EM-19 Motor, 1.8m Cable, without LED + Port (For Implantmed SI-1015 only)

May not be available in all markets.

\*Products available upon request.

## Terms and Conditions

**TERMS AND CONDITIONS OF SALE.** The following are the terms and conditions by which Keystone Dental, Inc. sells its products. As used herein, the term “Keystone” means Keystone Dental, Inc. and its applicable affiliates; the term “Products” means the Keystone products and services described in this invoice, and “Purchaser” means the person or company purchasing the Products.

**GOVERNING TERMS.** Any purchase and shipment of Products shall be deemed to be on the terms and conditions stated herein. Any and all terms and conditions submitted by Purchaser are hereby rejected.

**TAXES.** The prices set forth herein do not include any sales, use, excise, ad valorem, property or other taxes applicable to the sale, use or delivery of the Products, all of which shall be paid by Purchaser separately or added to the contract price and paid by Purchaser to Keystone.

**PRICES.** The prices set forth for the Products are in United States Dollars. All prices shall be as of the invoice date, regardless of the date the Product is originally ordered from Keystone.

**DELIVERY.** Products sold hereunder shall be delivered F.O.B. shipping point. Purchaser shall assume responsibility for all subsequent delivery or shipping charges.

**ACCEPTANCE.** Purchaser must inspect all Products for defects and/or non-conformity within seven (7) calendar days of delivery. After this period, Purchaser will have accepted such Products.

**PAYMENT.** Payment terms shall be as set forth on the front of the invoice. If payment is late, the maximum statutory interest rate will apply on such late amount. Keystone may, in its sole discretion, suspend shipments of Products until full payment by Purchaser of all past due amounts to Keystone is made.

**RETURN; EXCHANGE.** Purchaser may return any Product within thirty (30) calendar days of the invoice date so long as there is an offsetting (exchange) order of equal or greater value. Purchaser may return any Product after thirty (30) calendar days from the invoice date, but no later than ninety (90) calendar days after the invoice date, so long as there is an offsetting (exchange) order of equal or greater value, provided, however, such returns shall be subject to a 15% re-stocking fee. Keystone will not accept any returns or exchanges after ninety (90) calendar days following the invoice date.

No biomaterial products (bone grafting and membrane) will be accepted for return or exchange. No returns or exchanges will be accepted for Products that (i) were originally sold as part of a kit, pack or set, (ii) were included on the original invoice at no charge, (iii) have less than six (6) months remaining before expiration or (iv) were custom ordered. The Purchaser shall pay all shipping costs associated with the return or exchange of a Product. No Products will be accepted by Keystone for return or exchange without an RMA number given to Purchaser by Keystone Customer Service. Returned Products must be unexpired, unopened and undamaged, returned freight prepaid.

**WARRANTY.** EXCEPT AS EXPRESSLY SET FORTH IN KEYSTONE'S LIFETIME IMPLANT WARRANTY PROGRAM, KEYSTONE DOES NOT MAKE ANY WARRANTY, EXPRESS OR IMPLIED, EXCEPT THAT ITS PRODUCTS SHALL BE FREE FROM DEFECTS IN MATERIAL AND/OR WORKMANSHIP. THIS WARRANTY APPLIES ONLY TO THE ORIGINAL PURCHASER. PURCHASER ASSUMES ALL RISKS AND LIABILITY RESULTING FROM THE USE OF THESE PRODUCTS, WHETHER USED SEPARATELY OR IN COMBINATION WITH OTHER PRODUCTS. THE WARRANTY DOES NOT APPLY IF THE FAILURE OF THE PRODUCT IS CAUSED BY TRAUMA OR ACCIDENT OR BY THE PATIENT IN WHOM THE IMPLANT WAS INSTALLED OR IF THE PURCHASER IS NOT CURRENT ON ALL OUTSTANDING PAYMENTS TO KEYSTONE AT THE TIME OF SUCH CLAIM. KEYSTONE MAY MODIFY OR TERMINATE ITS WARRANTY PROGRAM AT ANY TIME, HOWEVER ANY CHANGES TO THE WARRANTY PROGRAM WILL NOT AFFECT PRODUCTS ALREADY PURCHASED AT THE TIME OF SUCH CHANGE. PURCHASER'S SOLE REMEDY WITH RESPECT TO CLAIMS RELATED TO KEYSTONE PRODUCTS IS RESTRICTED TO THE WARRANTY POLICY.

**LIMITATION OF LIABILITY.** UNDER NO CIRCUMSTANCES SHALL KEYSTONE OR ANY OF ITS AFFILIATES BE LIABLE FOR BUSINESS INTERRUPTION, LOSS OF PROFITS, SPECIAL, INDIRECT, INCIDENTAL OR CONSEQUENTIAL DAMAGES OF ANY NATURE AND FROM ANY CAUSE WHETHER BASED IN CONTRACT, WARRANTY OR TORT (INCLUDING NEGLIGENCE) OR OTHER LEGAL THEORY, EVEN IF KEYSTONE HAS BEEN ADVISED OF THE POSSIBILITY OF SUCH DAMAGES.

**INTELLECTUAL PROPERTY.** All intellectual property rights in Products sold to Purchaser shall remain the exclusive property of Keystone and its licensors.

**PERSONAL DATA.** It is Purchaser's responsibility to obtain patient's consent to transfer any personal data to Keystone.

**TERMINATION.** Keystone may terminate this or any agreement with Purchaser to purchase its products upon immediate written notice if Purchaser fails to pay any of its debt obligations to Keystone on time.

**FORCE MAJEURE.** Keystone shall not be liable for any loss or damage due to failure or delay arising out of any cause beyond the reasonable control of Keystone. In the event of any failure or delay resulting from such causes, an equitable adjustment of delivery and any other appropriate terms and conditions shall be made. No such failure or delay shall be the basis for an increase in Keystone's obligations, nor any termination by Purchaser.

**VALIDITY.** If any provision of these Terms and Conditions is found to be illegal or unenforceable in any respect, such illegality or unenforceability shall not affect any other provision of these Terms and Conditions, all of which shall remain enforceable in accordance with their terms.

**GENERAL PROVISIONS.** The purchase of the Products and these Terms and Conditions are governed by the laws of the Commonwealth of Massachusetts, without regard to conflicts of law principles. Any dispute, claim or controversy arising out of or in connection with the purchase of the Products shall be resolved by arbitration in Boston, Massachusetts. This document incorporates all oral and written representations between the parties and constitutes the entire agreement and understanding of the parties with respect to the subject matter hereof and supersedes any and all other agreements either oral or written between the parties with respect to such subject matter. No amendment or modification may be made to this document unless in writing and duly executed by an authorized representative of Keystone. Keystone may subcontract, assign or transfer its obligations or rights to a competent third party. Purchaser may not assign or transfer any of its obligations without the consent of Keystone.



**Keystone Dental, Inc.  
Global Headquarters**

154 Middlesex Turnpike  
Burlington, MA 01803 USA  
General Inquiries: 781-328-3600  
Customer Relations: 866-902-9272 or 781-328-3490  
Fax: 866-903-9272 or 781-328-3400  
Email: [info@keystonedental.com](mailto:info@keystonedental.com)

**Keystone Dental, Inc.**

5 Holland, Bldg 209  
Irvine, CA 92618 USA  
Customer Service Number: 866-902-9272  
Fax: 866-903-9272 or 781-328-3400  
Email: [info@keystonedental.com](mailto:info@keystonedental.com)



**EMERGO Europe B.V.** 

Prinsessegracht 20  
2514 AP The Hague  
The Netherlands



**Caution, consult accompanying documents**

**Trademark Acknowledgements**  
TiLobe, PrimaPlus, Quick-Cap and "Smarter Thinking. Simpler Design." are trademarks and registered trademarks of Keystone Dental, Inc.