

RESTORE®

Product Catalog

Dear Customer,

Thank you for allowing Keystone Dental Inc. the opportunity to provide solutions which we hope meet or exceed your expectations.

Keystone Dental Inc. produces innovative, high quality dental implants, accessories, and biologics and distributes these products globally. Our headquarters are in Burlington, Massachusetts and we have state-of-the-art manufacturing facilities in both Burlington and Irvine, California.

Our range of implant products is broad, fulfilling both niche and standard requirements for all specialties. If you wish, at any time, to discuss Keystone Dental products, ongoing developments, and future research, or if you have any suggestions which you feel would help us serve you better, please call me directly at (781) 328-3387 or Toll Free at (866) 902-9272.

Again, thank you for allowing Keystone Dental, Inc. to satisfy your implant requirements, and I look forward to speaking with you in the future.

A handwritten signature in white ink that reads "Michael Kehoe". The signature is written in a cursive, flowing style.

Michael A. Kehoe
Keystone Dental, Inc.
President & CEO



RESTORE®

SD RESTORE® Implants Ø3.3 mm	4
SD Prosthetic Options Ø3.3 mm	5
SD Prosthetic Components Ø3.3 mm	6
RD RESTORE® Implants Ø3.75 mm/4.0 mm	8
RD Prosthetic Options Ø3.75 mm/4.0 mm	9
RD Prosthetic Components Ø3.75 mm/4.0 mm	10
WD RESTORE® Implants Ø5.0 mm/6.0 mm	12
WD Prosthetic Options Ø5.0 mm/6.0 mm	13
WD Prosthetic Components Ø5.0 mm/6.0 mm	14
Overdenture Options	16
O-Ring Abutments	17
Snap Abutments	18
RESTORE® Surgical Kit	19
Surgical Instrumentation	20
Drivers	24
Laboratory Instruments & Other Products	25

Product specifications are subject to change without notice.
 Items illustrated are not to scale.
 All items may not be available in all markets.



RESTORE Implants External Hex

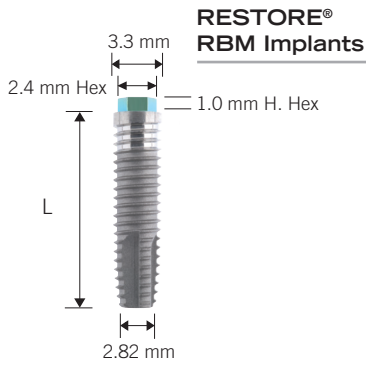

Implant Size

- Ø3.3 x 8 mm
- Ø3.3 x 10 mm
- Ø3.3 x 11.5 mm
- Ø3.3 x 13 mm
- Ø3.3 x 15 mm

Catalog

- RS3308K**
- RS3310K**
- RS3311K**
- RS3313K**
- RS3315K**

Cover Screw*



Description

SD

Catalog

L1809-34-01K

Healing Abutments**



Description

- SD
- SD
- SD

- SD
- SD
- SD

- SD
- SD
- SD

Flare

- Straight
- Straight
- Straight

- 4.2 mm
- 4.2 mm
- 4.2 mm

- 5.5 mm
- 5.5 mm
- 5.5 mm

Cuff Height

- 2.0 mm
- 4.0 mm
- 6.0 mm

- 2.0 mm
- 4.0 mm
- 6.0 mm

- 2.0 mm
- 4.0 mm
- 6.0 mm

Catalog

- R9633-34-02K**
- R9633-34-04K**
- R9633-34-06K**

- R9642-34-02K**
- R9642-34-04K**
- R9642-34-06K**

- R9655-34-02K**
- R9655-34-04K**
- R9655-34-06K**

* .035" Hex Driver required for RESTORE Cover Screw.
 ** .048" Hex Driver required for RESTORE Healing Abutments.

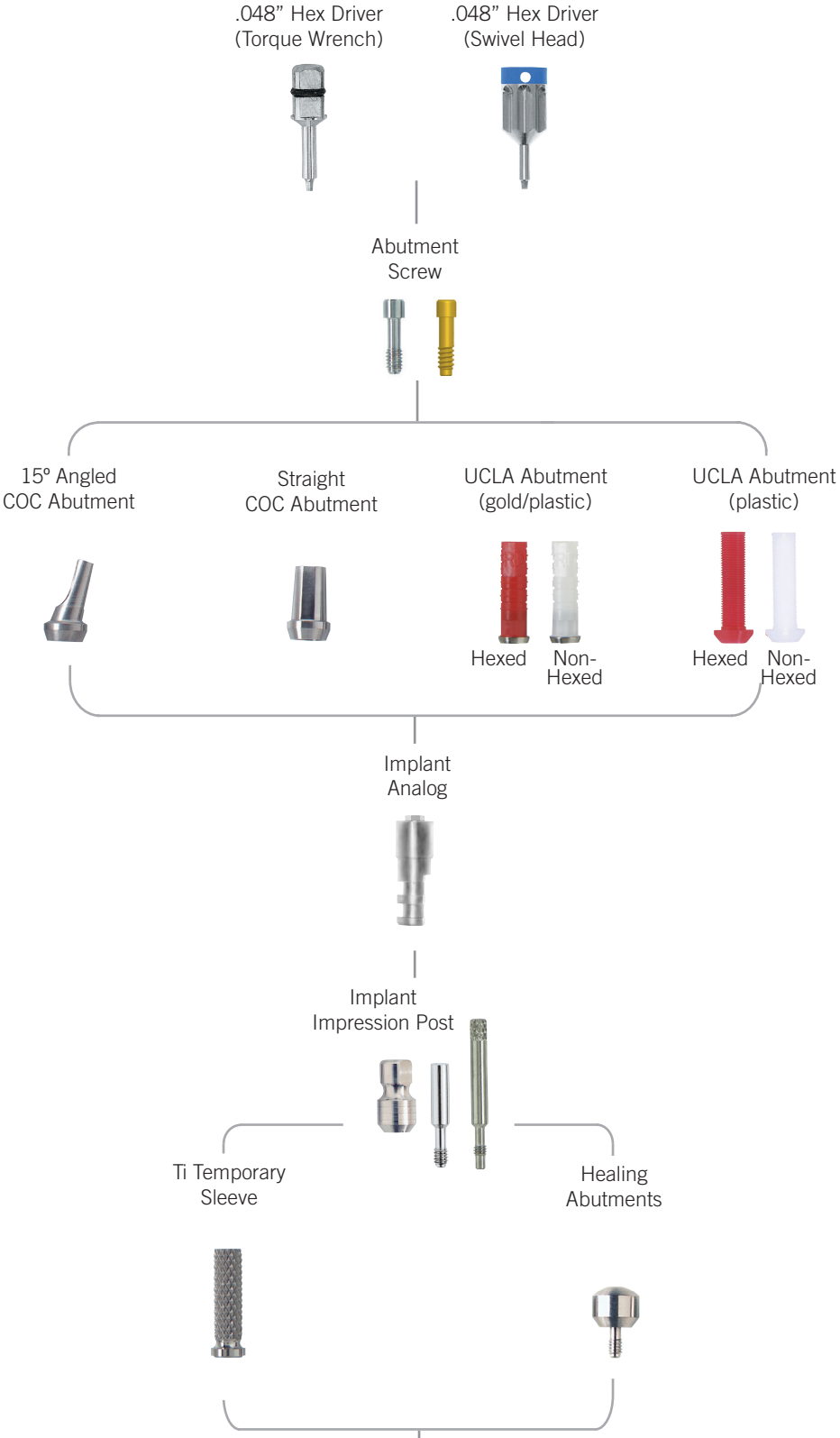



Implant Impression Posts

Description

Flare

Catalog #

SD, Hexed
SD, Hexed
SD, Hexed

Straight
4.2 mm
5.5 mm

R9549-34-00K
R9550-34-00K
R9551-34-00K

SD, Non-Hexed

Straight

R9593-34-01K



Implant Analog

Description

Catalog #

SD, 1-Pack

R9893-34K



Ti Temporary Sleeves

Description

Catalog #

SD, Hexed
SD, Non-Hexed

L2301-42-00K
L2301-42-01K



Straight Cement-On-Crown (COC) Abutments

Description

Cuff Height

Catalog #

SD, Locking
SD, Locking
SD, Locking

No Cuff
2.0 mm
4.0 mm

L2308-34-04K
R9290-34-02K
R9290-34-04K

SD, Non-Locking

2.0 mm

R2302-42-02K



Angled Cement-On-Crown (COC) Abutments

Description

Cuff Height

Catalog #

SD, 15° Angled, Locking
SD, 15° Angled, Locking

2.0 mm
4.0 mm

R9291-34-02K
R9291-34-04K







UCLA Gold/Plastic Sleeves

Description

Catalog #

SD, Hexed
SD, Non-Hexed

L2307-42-00K
L2307-42-01K

UCLA Plastic Sleeves		<i>Description</i>	<i>Flare</i>	<i>Catalog #</i>
		SD, Hexed	4.2 mm	R9250-34-00K
		SD, Hexed	5.5 mm	R9251-34-00K
		SD, Non-Hexed	4.2 mm	L2305-42-01K
Abutment Screws*		<i>Description</i>	<i>Catalog #</i>	
		SD Abutment Screw, Ti, .048" Hex	R9203-34-48K	
		SD Abutment Screw, TiN, .048" Hex	R9301-34-48K	

*Abutment Screws not sold with abutments, must be purchased separately.
.048" Hex Driver required for RESTORE Abutment Screws.



RESTORE Implants External Hex

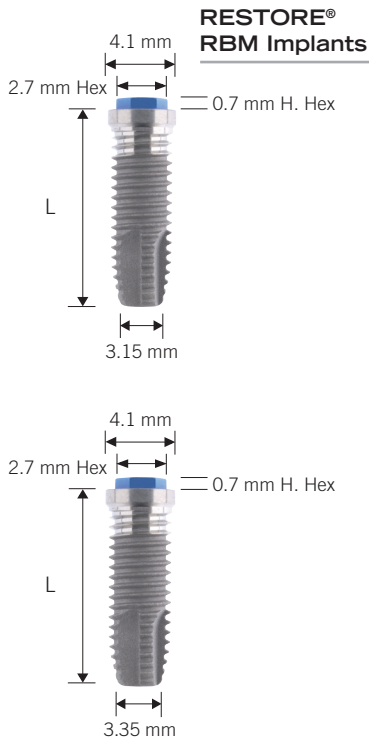

Implant Size

- Ø3.75 x 8 mm
- Ø3.75 x 10 mm
- Ø3.75 x 11.5 mm
- Ø3.75 x 13 mm
- Ø3.75 x 15 mm

Catalog

- RS3808K**
- RS3810K**
- RS3811K**
- RS3813K**
- RS3815K**

- Ø4.0 x 8 mm
- Ø4.0 x 10 mm
- Ø4.0 x 11.5 mm
- Ø4.0 x 13 mm
- Ø4.0 x 15 mm

- RS4008K**
- RS4010K**
- RS4011K**
- RS4013K**
- RS4015K**

Cover Screw*



Description

RD

Catalog

L1809-40-01K

Healing Abutments**



Description

RD
RD
RD

Flare

Straight
Straight
Straight

Cuff Height

2.0 mm
4.0 mm
6.0 mm

Catalog

R9633-40-02K
R9633-40-04K
R9633-40-06K

RD
RD
RD
RD
RD

5.0 mm
5.0 mm
5.0 mm
5.0 mm
5.0 mm

2.0 mm
3.0 mm
4.0 mm
6.0 mm
8.0 mm

R9650-40-02K
R9650-40-03K
R9650-40-04K
R9650-40-06K
R9650-40-08K

RD
RD
RD
RD

6.0 mm
6.0 mm
6.0 mm
6.0 mm

2.0 mm
4.0 mm
6.0 mm
8.0 mm

R9660-40-02K
R9660-40-04K
R9660-40-06K
R9660-40-08K

All RESTORE implants have a 3.0 mm machined collar, except the 6.5 mm which has a machined collar of 1.5 mm.

*.035" Hex Driver required for RESTORE Cover Screw.

** .048" Hex Driver required for RESTORE Healing Abutments.

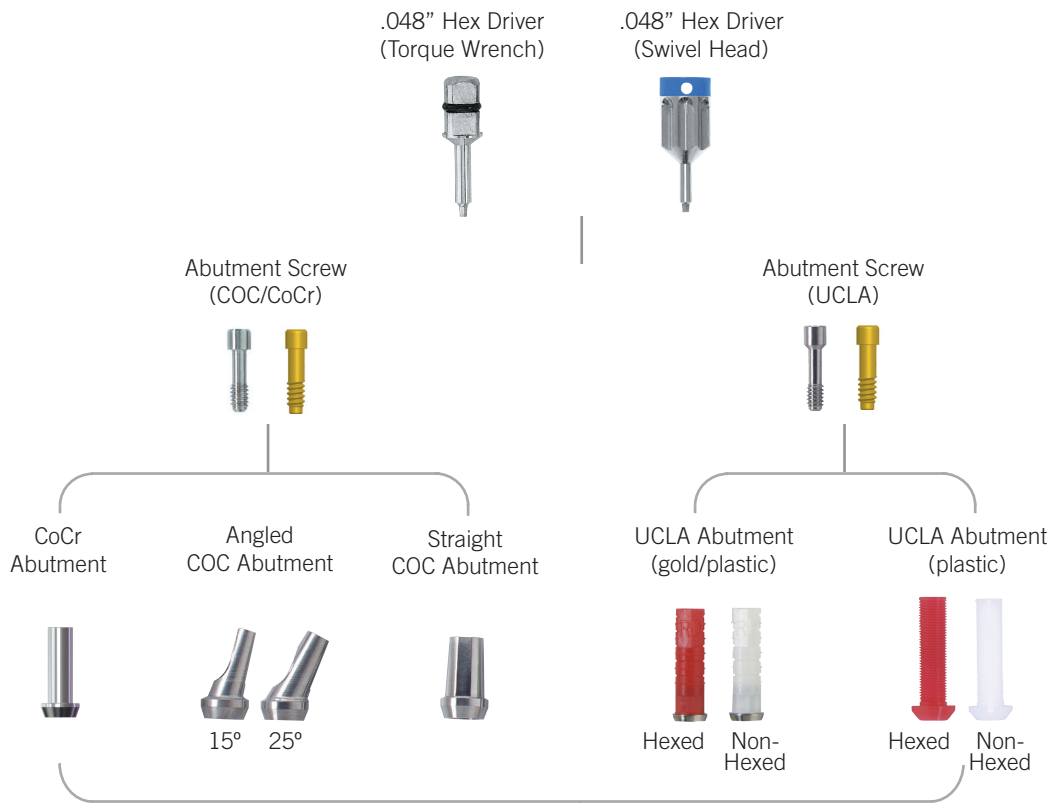

Implant Analog



Implant Impression Post

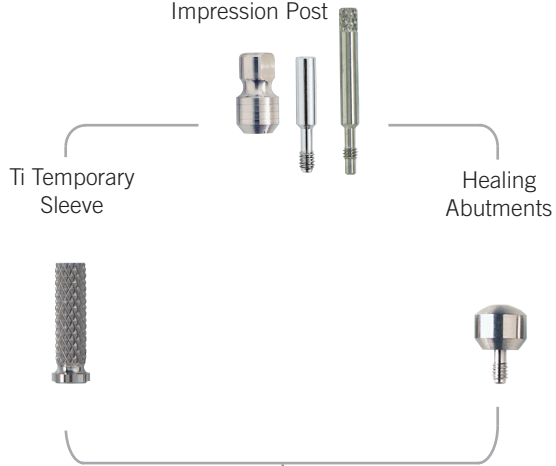



Prosthetic Components External Hex



Implant Impression Posts

Description

- RD, Hexed
- RD, Hexed
- RD, Hexed
- RD, Non-Hexed

Flare

- Straight
- 5.0 mm
- 6.0 mm
- Straight

Catalog

- R9549-40-00K**
- R9550-40-00K**
- R9551-40-00K**
- R9593-40-01K**



Implant Analogs

Description

- RD, 1-Pack
- RD, 3-Pack

Catalog

- R9891-40K**
- R9892-40K**



Ti Temporary Sleeves

Description

- RD, Hexed
- RD, Non-Hexed

Catalog

- L2400-50-00K**
- L2400-50-01K**



Straight Cement-On-Crown (COC) Abutments

Description

- RD, Locking
- RD, Locking
- RD, Locking
- RD, Non-Locking

Cuff Height

- No Cuff
- 2.0 mm
- 4.0 mm
- 2.0 mm

Catalog

- L2308-40-04K**
- R9290-40-02K**
- R9290-40-04K**
- R9295-40-02K**



Angled Cement-On-Crown (COC) Abutments

Description

- RD, 15° Angled, Locking
- RD, 15° Angled, Locking
- RD, 25° Angled, Locking
- RD, 25° Angled, Locking

Cuff Height

- 2.0 mm
- 4.0 mm
- 2.0 mm
- 4.0 mm

Catalog

- R9291-40-02K**
- R9291-40-04K**
- R9292-40-02K**
- R9292-40-04K**



UCLA Gold/Plastic Sleeves



Description

- RD, Hexed
- RD, Non-Hexed

Catalog

- L2405-50-00K**
- L2405-50-01K**



	<i>Description</i>	<i>Flare</i>	<i>Catalog #</i>
 <p>UCLA Plastic Sleeves</p>	RD, Hexed	5.0 mm	R9250-40-00K
	RD, Hexed	6.0 mm	R9251-40-00K
	RD, Non-Hexed	5.0 mm	L2403-50-01K
 <p>Cobalt Chrome (CoCr) Abutment</p>	RD, Non-Hexed (includes Plastic Sleeve and Abutment Screw)		L2601-50-00K
 <p>Abutment Screws*</p>	RD Abutment Screw, Ti, .048" Hex - COC/CoCr		R9202-40-48K
	RD Abutment Screw, TiN, .048" Hex - COC/CoCr		R9302-40-48K
	RD Abutment Screw, Ti, .048" Hex - UCLA		R9203-40-48K
	RD Abutment Screw, TiN, .048" Hex - UCLA		R9304-40-48K

*Abutment Screws not sold with abutments, must be purchased separately.
.048" Hex Driver required for RESTORE Abutment Screws.



RESTORE Implants External Hex

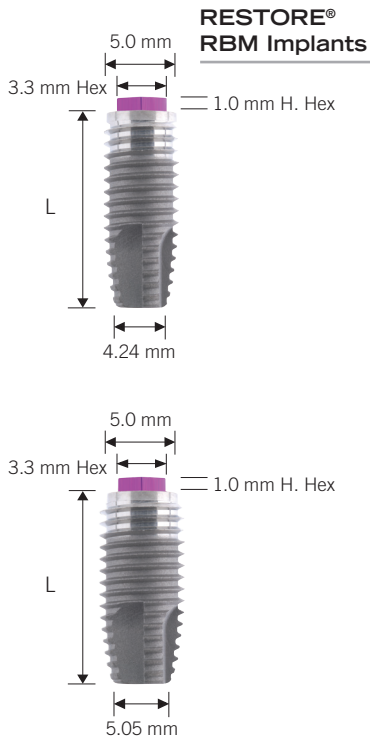

Implant Size

- Ø5.0 x 8 mm
- Ø5.0 x 10 mm
- Ø5.0 x 11.5 mm
- Ø5.0 x 13 mm
- Ø5.0 x 15 mm

Catalog

- RS5008K**
- RS5010K**
- RS5011K**
- RS5013K**
- RS5015K**

- Ø6.0 x 8 mm
- Ø6.0 x 10 mm
- Ø6.0 x 11.5 mm
- Ø6.0 x 13 mm
- Ø6.0 x 15 mm

- RS6008K**
- RS6010K**
- RS6011K**
- RS6013K**
- RS6015K**

Cover Screw*



Description

WD

Catalog

L1809-50-01K

Healing Abutments**



Description

- WD
- WD
- WD
- WD
- WD
- WD

Flare

- Straight
- Straight
- Straight
- 6.0 mm
- 6.0 mm
- 6.0 mm
- 7.5 mm

Cuff Height

- 2.0 mm
- 4.0 mm
- 6.0 mm
- 2.0 mm
- 4.0 mm
- 6.0 mm
- 4.0 mm

Catalog

- R9633-50-02K**
- R9633-50-04K**
- R9633-50-06K**
- R9606-50-02K**
- R9606-50-04K**
- R9606-50-06K**
- R9676-50-04K**

All RESTORE implants have a 3.0 mm machined collar, except the 6.5 mm which has a machined collar of 1.5 mm.

*.035" Hex Driver required for RESTORE Cover Screw.

** .048" Hex Driver required for RESTORE Healing Abutments.

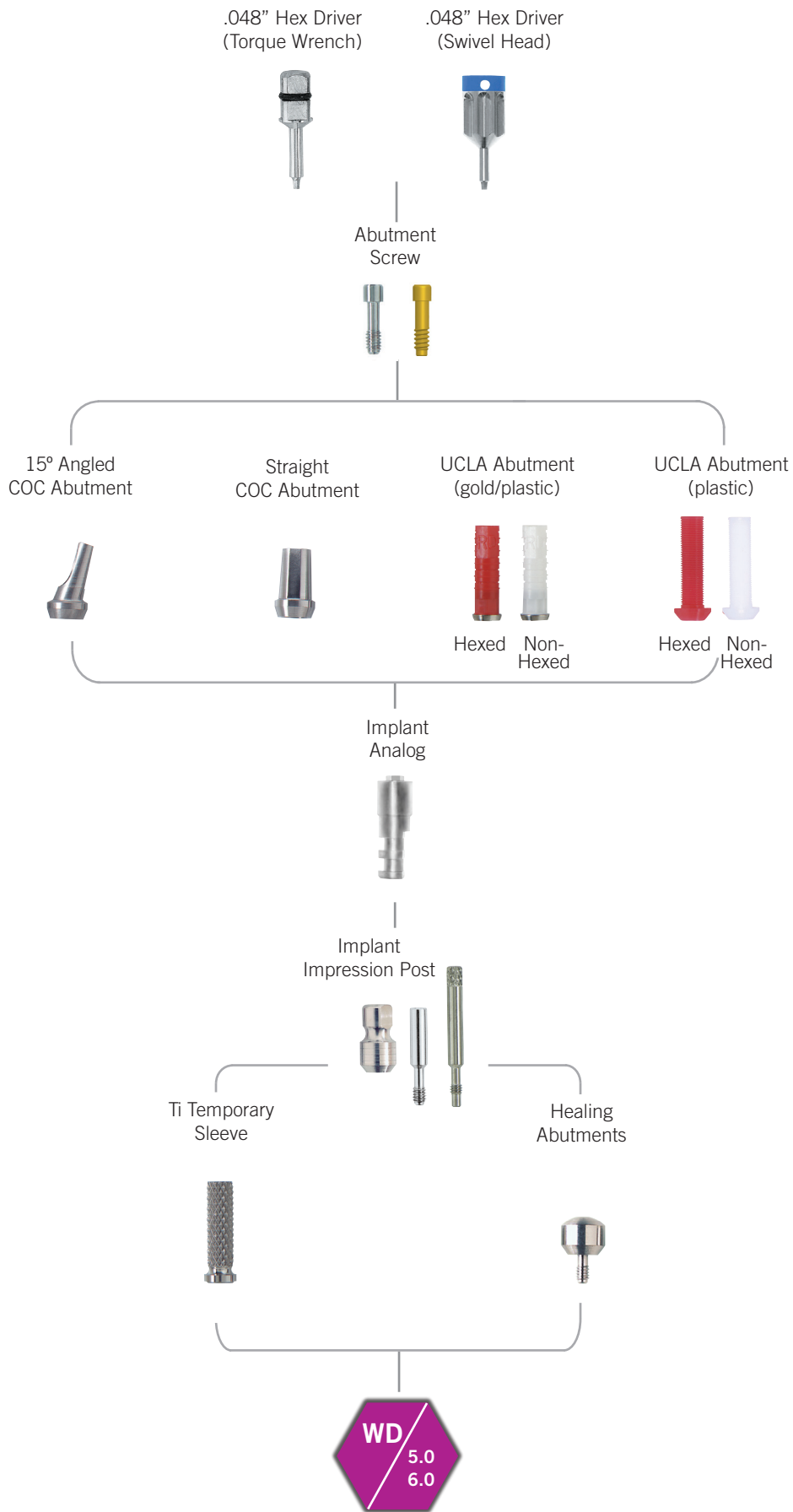



Prosthetic Components External Hex



Implant Impression Posts

Description

- WD, Hexed
- WD, Hexed
- WD, Hexed
- WD, Non-Hexed

Flare

- Straight
- 6.0 mm
- 7.5 mm
- Straight

Catalog

- R9549-50-00K**
- R9597-50-00K**
- R9598-50-00K**
- R9593-50-01K**



Implant Analog

Description

- WD, 1-Pack

Catalog

- R9893-50K**



Ti Temporary Sleeves

Description

- WD, Hexed
- WD, Non-Hexed

Catalog

- L2500-60-00K**
- L2500-60-01K**



Straight Cement-On-Crown (COC) Abutments

Description

- WD, Locking
- WD, Locking
- WD, Locking
- WD, Non-Locking

Cuff Height

- No Cuff
- 2.0 mm
- 4.0 mm
- 2.0 mm

Catalog

- L2308-50-04K**
- R9290-50-02K**
- R9290-50-04K**
- R2503-60-02K**



Angled Cement-On-Crown (COC) Abutments

Description

- WD, 15° Angled, Locking
- WD, 15° Angled, Locking

Cuff Height

- 2.0 mm
- 4.0 mm

Catalog

- R9291-50-02K**
- R9291-50-04K**



UCLA Gold/Plastic Sleeves

Description

- WD, Hexed
- WD, Non-Hexed

Catalog

- L2508-60-00K**
- L2508-60-01K**



UCLA Plastic Sleeves		<i>Description</i>	<i>Flare</i>	<i>Catalog #</i>
		WD, Hexed	6.0 mm	R9226-50-00K
		WD, Non-Hexed	6.0 mm	R9226-50-01K
Abutment Screws*		<i>Description</i>		<i>Catalog #</i>
		WD Abutment Screw, Ti, .048" Hex		R9203-50-48K
		WD Abutment Screw, TiN, .048" Hex		R9303-50-48K

*Abutment Screws not sold with abutments, must be purchased separately.
.048" Hex Driver required for RESTORE Abutment Screws.



Overdenture Options External Hex

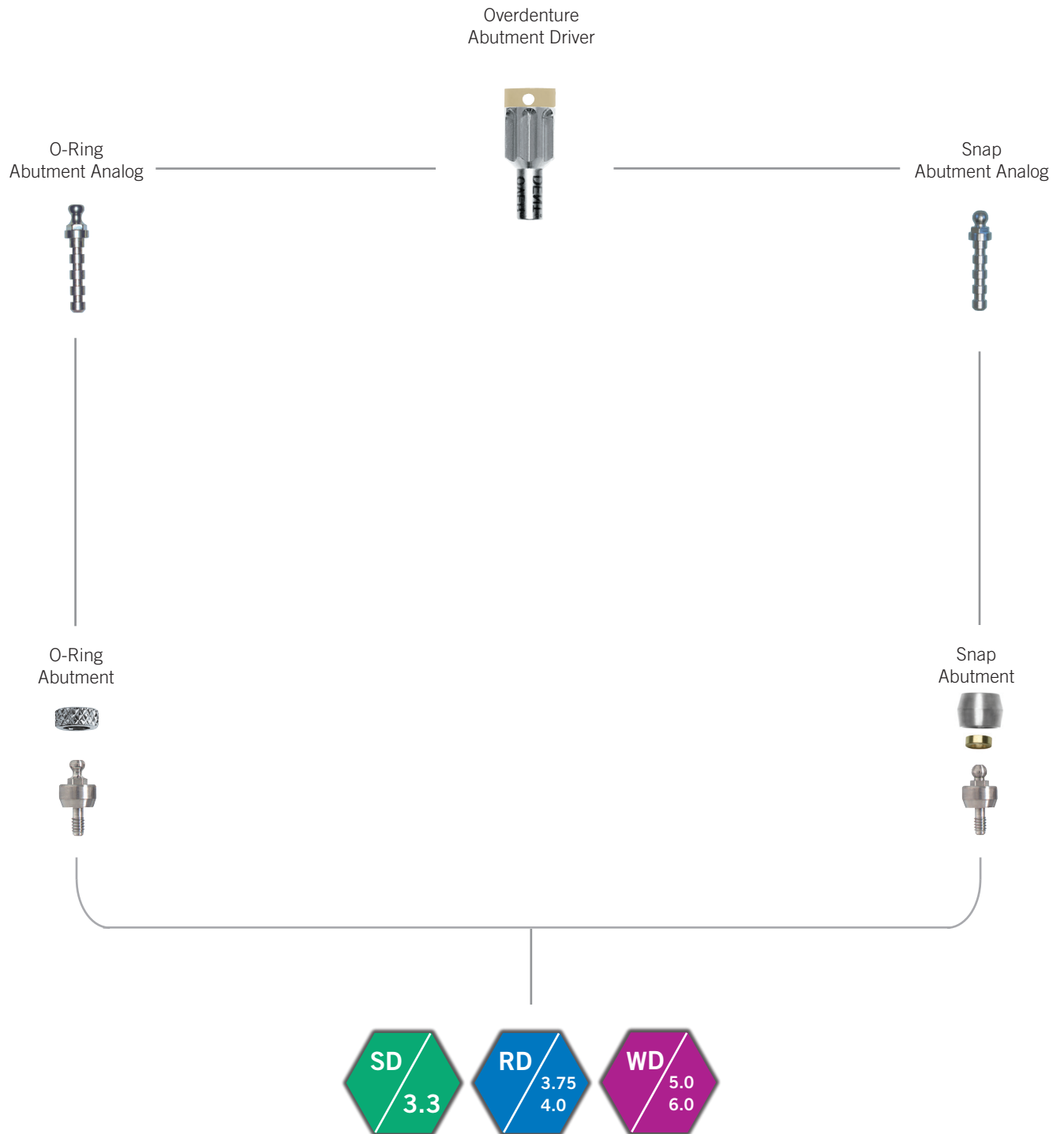



O-Ring Abutments



Description

Cuff Height

Catalog #

SD	2.0 mm	L2304-42-02K
SD	3.0 mm	L2304-42-03K
SD	4.0 mm	L2304-42-04K
RD	2.0 mm	L2402-50-02K
RD	3.0 mm	L2402-50-03K
RD	4.0 mm	L2402-50-04K
WD	2.0 mm	L2505-60-02K
WD	3.0 mm	L2505-60-03K
WD	4.0 mm	L2505-60-04K

O-Ring Abutment Accessories



Description

Catalog #



O-Ring Abutment Analog	L2805-01K
Titanium Keeper	L2810-01K
Clinical O-Rings, Black, 12-Pack	L2811-01K
Processing O-Rings, Red, 12-Pack	L2812-01K



Snap Abutments External Hex

Snap Abutments



Description

Cuff Height

Catalog

SD	2.0 mm	41000K
SD	3.0 mm	41001K
SD	4.0 mm	41002K
RD	2.0 mm	41003K
RD	3.0 mm	41004K
RD	4.0 mm	41005K
WD	2.0 mm	841006K
WD	3.0 mm	41007K

Snap Abutment Accessories



Description

Catalog

Retention Inserts, Red, Low Retention, 6-Pack	40003K
Retention Inserts, Yellow, Medium Retention, 6-Pack	40004K
Retention Inserts, Blue, High Retention, 6-Pack	40005K
Housing with Low Retention Insert and Lab Spacer	40006K
Retention Insert Seating Tool	40007K
Snap Abutment Analog	L284-01K
Overdenture Abutment Driver, Swivel Head (8 mm)	L2100-96-19K
Overdenture Abutment Driver, Latch-type (20 mm)	L1404-96-20K
Overdenture Abutment Driver Tip for Torque Wrench (8mm)	L2101-96-16K



Initial Drills



Description

Ø1.6 x 15 mm, Non-Irrigated

Catalog #

L1104-16-15K



Ø2.0 x 10 mm, Non-Irrigated
Ø2.0 x 15 mm, Non-Irrigated

L1104-20-10K
L1104-20-15K

Surgical Drills



Description

Ø2.8 x 10 mm, Non-Irrigated
Ø2.8 x 15 mm, Non-Irrigated

Catalog #

L1101-28-10K
L1101-28-15K



Ø3.0 x 10 mm, Non-Irrigated
Ø3.0 x 15 mm, Non-Irrigated

L1104-30-10K
L1104-30-15K



Ø3.3 x 10 mm, Non-Irrigated
Ø3.3 x 15 mm, Non-Irrigated

L1104-33-10K
L1104-33-15K



Ø4.2 x 10 mm, Irrigated
Ø4.2 x 15 mm, Irrigated

L1104-42-10K
L1104-42-15K



Ø5.2 x 10 mm, Irrigated
Ø5.2 x 15 mm, Irrigated

L1104-52-10K
L1104-52-15K

Countersink Drill



Description

For placement of Ø3.75/ Ø4.0 mm implants, Non-Irrigated

Catalog #

L1404-38-02K



Pilot Drills



Description

2.0/3.0 mm, Irrigated
 2.0/3.0 mm, Non-Irrigated
 3.0/4.2 mm, Irrigated
 3.4/4.2 mm, Irrigated
 4.2/5.0 mm, Irrigated
 4.2/5.2 mm, Irrigated

Catalog

L1300-20-30K
L1301-20-30K
L1300-30-42K
L1300-34-42K
L1300-42-50K
L1300-42-52K

Surgical Taps



Description

Ø3.3 x 13 mm, Irrigated
 Ø3.3 x 18 mm, Irrigated

Catalog

L1502-33-13K
L1502-33-18K



Ø3.75 x 13 mm, Irrigated
 Ø3.75 x 18 mm, Irrigated

L1504-38-13K
L1504-38-18K



Ø4.0 x 13 mm, Irrigated
 Ø4.0 x 18 mm, Irrigated

L1504-40-13K
L1504-40-18K



Ø5.0 x 13 mm, Irrigated
 Ø5.0 x 15 mm, Irrigated

L1504-50-13K
L1504-50-15K



Ø6.0 x 13 mm, Irrigated
 Ø6.0 x 15 mm, Irrigated

L1504-60-13K
L1504-60-15K

Bone Profiler System



Description

SD Ø4.2 mm Flare (with Guide Pin)
 SD Ø5.5 mm Flare (with Guide Pin)
 SD Guide Pin, 2-Pack

Catalog

L1408-42K
L1408-55K
L1411-01K

RD Ø5.0 mm Flare (with Guide Pin)
 RD Ø6.0 mm Flare (with Guide Pin)
 RD Guide Pin, 2-Pack

L1409-50K
L1409-60K
L1412-01K

WD Ø6.0 mm Flare (with Guide Pin)
 WD Ø7.5 mm Flare (with Guide Pin)
 WD Guide Pin, 2-Pack

L1410-60K
L1410-75K
L1413-01K



Placement Heads



Description

SD 5.5 mm Length
SD 15 mm Length

Catalog #

R9192-33-05K
R9192-33-15K

RD 5.5 mm Length
RD 15 mm Length

R9192-40-05K
R9192-40-15K

WD 15 mm Length

R9192-50-15K

Stabilizing Wrench



Description

Stabilizing Wrench

Catalog #

L1709-01K

Surgical Ratchet



Description

Surgical Ratchet

Catalog #

L1702-01K

**Surgical Ratchet/
Torque Wrench**



Description

Surgical Ratchet/Torque Wrench

Catalog #

K15695

**Ratchet Adapters &
Extenders**



Description

Ratchet Adapter, Short (8 mm)

Catalog #

L1806-04K

Ratchet/Tap Adapter, Long (12 mm)

L1806-05K

Ratchet Extenders, Short & Long

L1703-01K

Replacement O-Rings for Ratchet Adapter, 4-Pack

L1806-03K

Surgical Depth Probe



Description

Surgical Depth Probe

Catalog #

L1805-01K

**Conversion Handle,
Latch Type Instruments**

Description

Conversion Handle, Latch Type Instruments

Catalog #
L1407K
**Hand Adapter,
Placement Heads**

Description

Hand Adapter, Placement Heads

Catalog #
L1406-02K
Handpiece Adapter

Description

 Handpiece Adapter, Short
Handpiece Adapter, Long

Catalog #
L1406-01K
13085K
Surgical Hand Driver

Description

Surgical Hand Driver

Catalog #
L1414-01K
Drill Extender

Description

Drill Extender

Catalog #
L1404-01K
Irrigation Port Cleaner

Description

Irrigation Port Cleaner

Catalog #
L1800-22-02
Parallel Pin

Description

 Straight, 2.0/3.0 mm, 4-Pack
15° Angled, 2.0/3.0 mm, 2-Pack
25° Angled, 2.0/3.0 mm, 2-Pack

Catalog #
L1805-20-00K
L1805-20-15K
L1805-20-25K



.035" Hex Drivers



Description

Swivel Head, Short (8 mm/19 mm total length)
Swivel Head, Long (13 mm/24 mm total length)

Catalog #

L2100-35-19K
L2100-35-24K



Latch Type, Short (23 mm total length)
Latch Type, Long (28 mm total length)

L1400-35-23K
L1400-35-28K



For Torque Wrench, Short (8 mm)

ISS1117K

.048" Hex Drivers



Description

Swivel Head, Short (8 mm/19 mm total length)
Swivel Head, Long (13 mm/24 mm total length)

Catalog #

R9121K
R9122K



Latch Type, Short (23 mm total length)
Latch Type, Long (28 mm total length)

L1400-48-23K
L1400-48-28K



For Torque Wrench, Short (8 mm)
For Torque Wrench, Long (15 mm)

ISS1104K
ISS1109K

O-Ring Abutment Drivers



Description

Swivel Head

Catalog #

L2100-96-19K



Latch Type

L1404-96-20K



For Torque Wrench

L2101-96-16K



Component Pack



Description

Component Pack

Catalog #

L1812-01K

Reamers & Handle



Description

Reamer Handle, UCLA, Swivel Head

Catalog #

L2802-01K

SD Reamer, UCLA
RD Reamer UCLA
WD Reamer UCLA

L2800-01K
L2800-02K
L2800-03K

Waxing Pins



Description

SD, UCLA, .048" Hex
RD, UCLA, .048" Hex
WD, UCLA, .048" Hex

Catalog #

R9394-34K
R9595-40K
R9595-50-48K

**Hader Bar
& Clip System**



Description

Hader Bar & Clip System (includes 1 Hader Bar,
6 Processing Clips, 6 Final Clips, & 1 Seating Tool)

Catalog #

ISS185HK

Hader Castable Bar

ISS185BK

Hader Processing Clips, 6-Pack

ISS185HPK

Hader Final Clips, 6-Pack

ISS185HRK

Hader Clip Seating Tool

ISS185TK

Hader Metal Housing Clips, 6-Pack

ISS526HK



**Internal Thread Taps
for Implants**



Description

SD, I-72 Thread
RD, M2.0 Thread
WD, M2.5 Thread

Catalog #

L1700-72K
L1700-20K
L1700-25K

Terms and Conditions

TERMS AND CONDITIONS OF SALE. The following are the terms and conditions by which Keystone Dental, Inc. sells its products. As used herein, the term "Keystone" means Keystone Dental, Inc. and its applicable affiliates; the term "Products" means the Keystone products and services described in this invoice, and "Purchaser" means the person or company purchasing the Products.

GOVERNING TERMS. Any purchase and shipment of Products shall be deemed to be on the terms and conditions stated herein. Any and all terms and conditions submitted by Purchaser are hereby rejected.

TAXES. The prices set forth herein do not include any sales, use, excise, ad valorem, property or other taxes applicable to the sale, use or delivery of the Products, all of which shall be paid by Purchaser separately or added to the contract price and paid by Purchaser to Keystone.

PRICES. The prices set forth for the Products are in United States Dollars. All prices shall be as of the invoice date, regardless of the date the Product is originally ordered from Keystone.

DELIVERY. Products sold hereunder shall be delivered F.O.B. shipping point. Purchaser shall assume responsibility for all subsequent delivery or shipping charges.

ACCEPTANCE. Purchaser must inspect all Products for defects and/or non-conformity within seven (7) calendar days of delivery. After this period, Purchaser will have accepted such Products.

PAYMENT. Payment terms shall be as set forth on the front of the invoice. If payment is late, the maximum statutory interest rate will apply on such late amount. Keystone may, in its sole discretion, suspend shipments of Products until full payment by Purchaser of all past due amounts to Keystone is made.

RETURN; EXCHANGE. Purchaser may return any Product within thirty (30) calendar days of the invoice date so long as there is an offsetting (exchange) order of equal or greater value. Purchaser may return any Product after thirty (30) calendar days from the invoice date, but no later than ninety (90) calendar days after the invoice date, so long as there is an offsetting (exchange) order of equal or greater value, provided, however, such returns shall be subject to a 15% re-stocking fee. Keystone will not accept any returns or exchanges after ninety (90) calendar days following the invoice date.

No biomaterial products (bone grafting and membrane) will be accepted for return or exchange. No returns or exchanges will be accepted for Products that (i) were originally sold as part of a kit, pack or set, (ii) were included on the original invoice at no charge, (iii) have less than six (6) months remaining before expiration or (iv) were custom ordered. The Purchaser shall pay all shipping costs associated with the return or exchange of a Product. No Products will be accepted by Keystone for return or exchange without an RMA number given to Purchaser by Keystone Customer Service. Returned Products must be unexpired, unopened and undamaged, returned freight prepaid.

WARRANTY. EXCEPT AS EXPRESSLY SET FORTH IN KEYSTONE'S LIFETIME IMPLANT WARRANTY PROGRAM, KEYSTONE DOES NOT MAKE ANY WARRANTY, EXPRESS OR IMPLIED, EXCEPT THAT ITS PRODUCTS SHALL BE FREE FROM DEFECTS IN MATERIAL AND/OR WORKMANSHIP. THIS WARRANTY APPLIES ONLY TO THE ORIGINAL PURCHASER. PURCHASER ASSUMES ALL RISKS AND LIABILITY RESULTING FROM THE USE OF THESE PRODUCTS, WHETHER USED SEPARATELY OR IN COMBINATION WITH OTHER PRODUCTS. THE WARRANTY DOES NOT APPLY IF THE FAILURE OF THE PRODUCT IS CAUSED BY TRAUMA OR ACCIDENT OR BY THE PATIENT IN WHOM THE IMPLANT WAS INSTALLED OR IF THE PURCHASER IS NOT CURRENT ON ALL OUTSTANDING PAYMENTS TO KEYSTONE AT THE TIME OF SUCH CLAIM. KEYSTONE MAY MODIFY OR TERMINATE ITS WARRANTY PROGRAM AT ANY TIME, HOWEVER ANY CHANGES TO THE WARRANTY PROGRAM WILL NOT AFFECT PRODUCTS ALREADY PURCHASED AT THE TIME OF SUCH CHANGE. PURCHASER'S SOLE REMEDY WITH RESPECT TO CLAIMS RELATED TO KEYSTONE PRODUCTS IS RESTRICTED TO THE WARRANTY POLICY.

LIMITATION OF LIABILITY. UNDER NO CIRCUMSTANCES SHALL KEYSTONE OR ANY OF ITS AFFILIATES BE LIABLE FOR BUSINESS INTERRUPTION, LOSS OF PROFITS, SPECIAL, INDIRECT, INCIDENTAL OR CONSEQUENTIAL DAMAGES OF ANY NATURE AND FROM ANY CAUSE WHETHER BASED IN CONTRACT, WARRANTY OR TORT (INCLUDING NEGLIGENCE) OR OTHER LEGAL THEORY, EVEN IF KEYSTONE HAS BEEN ADVISED OF THE POSSIBILITY OF SUCH DAMAGES.

INTELLECTUAL PROPERTY. All intellectual property rights in Products sold to Purchaser shall remain the exclusive property of Keystone and its licensors.

PERSONAL DATA. It is Purchaser's responsibility to obtain patient's consent to transfer any personal data to Keystone.

TERMINATION. Keystone may terminate this or any agreement with Purchaser to purchase its products upon immediate written notice if Purchaser fails to pay any of its debt obligations to Keystone on time.

FORCE MAJEURE. Keystone shall not be liable for any loss or damage due to failure or delay arising out of any cause beyond the reasonable control of Keystone. In the event of any failure or delay resulting from such causes, an equitable adjustment of delivery and any other appropriate terms and conditions shall be made. No such failure or delay shall be the basis for an increase in Keystone's obligations, nor any termination by Purchaser.

VALIDITY. If any provision of these Terms and Conditions is found to be illegal or unenforceable in any respect, such illegality or unenforceability shall not affect any other provision of these Terms and Conditions, all of which shall remain enforceable in accordance with their terms.

GENERAL PROVISIONS. The purchase of the Products and these Terms and Conditions are governed by the laws of the Commonwealth of Massachusetts, without regard to conflicts of law principles. Any dispute, claim or controversy arising out of or in connection with the purchase of the Products shall be resolved by arbitration in Boston, Massachusetts. This document incorporates all oral and written representations between the parties and constitutes the entire agreement and understanding of the parties with respect to the subject matter hereof and supersedes any and all other agreements either oral or written between the parties with respect to such subject matter. No amendment or modification may be made to this document unless in writing and duly executed by an authorized representative of Keystone. Keystone may subcontract, assign or transfer its obligations or rights to a competent third party. Purchaser may not assign or transfer any of its obligations without the consent of Keystone.

Keystone Dental, Inc.
Global Headquarters
154 Middlesex Turnpike
Burlington, MA 01803 USA
General Inquiries: 781-328-3600
Customer Relations: 866-902-9272 or 781-328-3490
Email: info@keystonedental.com



Keystone Dental, Inc.
5 Holland, Bldg 209
Irvine, CA 92618 USA
Customer Service Number:
Email: info@keystonedental.com



Keystone Dental, Inc.
Authorized European Representative
EMERGO Europe B.V
Prinsessegracht 20
2514 AP The Hague
The Netherlands
(+31 (0) 70 345 8570)



Caution, consult accompanying documents