

sister light mini

Design Federico de Majo

Lampada da tavolo ricaricabile • Rechargeable table lamp • Aufladbare Tischlamp • Lampe de table rechargeable • Lámpara de mesa recargable

| | | |
|---|----------------------|-------|
| Ⓜ | ISTRUZIONI D'USO | p. 1 |
| Ⓤ | INSTRUCTIONS FOR USE | p. 4 |
| Ⓓ | GEBRAUCHSANWEISUNG | p. 7 |
| Ⓕ | MODE D'EMPLOI | p. 10 |
| Ⓔ | INSTRUCCIONES DE USO | p. 13 |
| ⊕ | ACCESSORIES | p. 16 |
| 🔋 | BATTERY | p. 17 |

sister light mini

Lampada da tavolo ricaricabile

LD030603 oro anodizzato
LD0306R3 rame anodizzato
LD0306V3 verde anodizzato

LED DIMMER
3W • 250lm - 260lm - 270lm
2700K - 3350K - 4000K
IP65 • CRI>90 • 5Vdc max 2A
Ø 13,2 x h 32,8 x Ø 11,6 cm
Ø 5,2 x h 12,9 x Ø 4,6 in

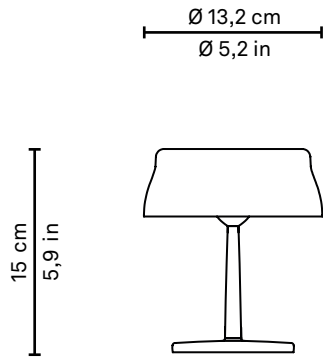

INCLUSI

Cavo di ricarica con entrata USB tipo C

Kit per fissaggio magnetico x 2

NON INCLUSI

LD0300UC
Carica batterie con doppia entrata USB

LD0340RA
Caricatore multipresa USB (8xUSB)

BAT04705506701900
Pacco batteria sostitutiva

KIT00012007000200
scheda LED sostitutiva



1. Consigli d'uso:

Questo prodotto serve esclusivamente a scopi di illuminazione e:

A) Non deve essere esposto a pesanti carichi meccanici o forti contaminazioni; **B)** può essere installato e usato solo previo controllo delle condizioni del prodotto; verificare che non risulti sporco e non abbia subito danneggiamenti durante lo stoccaggio; **C)** l'installazione e la manutenzione vanno eseguite ad apparecchio spento; **D)** modifiche o manomissioni del prodotto e il non rispetto delle indicazioni riportate possono rendere l'apparecchio pericoloso; **E)** i prodotti con grado di protezione 65 (IP65) sono idonei per uso esterno; **F)** per la pulizia di tutte le superfici metalliche e plastiche utilizzare un panno morbido asciutto; **G)** La ditta Zafferano declina ogni responsabilità per danni causati da un proprio prodotto montato in modo non conforme alle istruzioni.

2. Dati tecnici:

- Potenza: 3 W
- Volt: DC 5 V
- Flusso luminoso: 2700K 250 lm - 3350K 260 lm - 4000K 270 lm
- LED: HONGLITRONIC 2835 / (8+42 pz) 3 STEP MAC ADAM
- Pacco batteria al litio inclusa (consultare sezione accessori inclusi); per le istruzioni di sostituzione del pacco batteria consultare il sito web www.zafferanoitalia.com; usare solamente batterie originali per la sostituzione.
- Ricarica standard: 1A - 2A (max 2,5A)
- Ricarica: 5 ore a 2A - 10 ore a 1A
- Durata batteria: 100% 8 ore - 60% 13 ore - 30% 28 ore - 6% 58 ore
- Classe: III
- Grado di protezione: IP65
- CRI≥90
- In riferimento alla norma UNI EN ISO 9227, la resistenza della lampada all'esposizione a nebbia salina neutra (NSS) è garantita per 1500 ore.

3. Carica batterie:

- Per caricare il prodotto è possibile usare un carica batterie con entrata USB standard A.
- Carica batterie con doppia entrata USB NON INCLUSO: INPUT 100-240 V AC - 50/60Hz; OUTPUT DC 5V - 2.1 A.
- Per un corretto caricamento della lampada si consiglia di: 1- collegare il cavo USB all'adattatore; 2- collegare il cavo USB alla lampada; 3- collegare la spina alla presa elettrica; 4- a carica completata scollegare la spina dalla presa elettrica e rimuovere il cavo USB.
- La lampada funziona correttamente anche se collegata alla corrente.
- Si consiglia l'utilizzo del caricatore opzionale e del cavo in dotazione originale. In alternativa utilizzare un cavo e caricatore a 2A certificati.

4. Configurazione di fabbrica:

LUMINOSITÀ 100% - K 2700 - DIMMER ON - FISSAGGIO MECCANICO

5. Attenzione:

- Il piano d'appoggio della lampada non deve superare i 15° di inclinazione o rischia la caduta.
- La batteria è fornita delle seguenti protezioni: cortocircuito, sovra scarica, sovralimentazione, sovracorrente, sovratensione.
- Per preservare l'integrità della batteria si consiglia di mantenere la carica tra il 20% minimo e 80% massimo; se la lampada non viene utilizzata per lunghi periodi, si consiglia di procedere periodicamente ad un ciclo di carica/scarica del prodotto.
- Si prega di fare riferimento alle leggi locali per un corretto smaltimento e riciclaggio della batteria.



ISTRUZIONI D'USO

ACCENSIONE / DIMMERAZIONE / SPEGNIMENTO

Rapidi tocchi per:

- accendere
- cambiare la luminosità
- spegnere il dispositivo

La ripetizione degli step è ciclica.

Tenendo premuto il touch per due secondi, la lampada si spegne memorizzando lo step di dimmerazione corrente e riproponendolo all'accensione successiva.

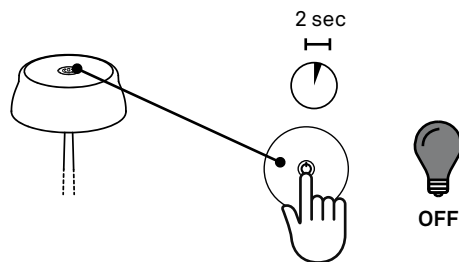
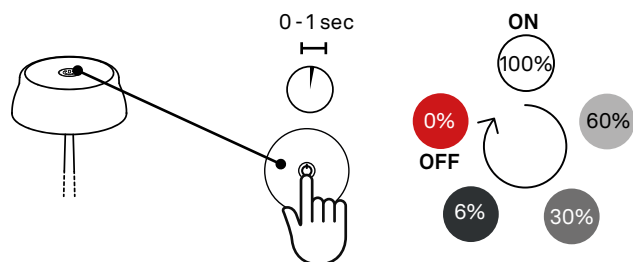

TEMPERATURA COLORE

Da lampada spenta, tenere premuto il touch:

- dopo 5 secondi si accende a 2700K
- dopo 10 secondi passa a 3350K
- dopo 15 secondi passa a 4000K

La ripetizione degli step è ciclica.

Interrompendo il tocco durante una delle fasi, la lampada memorizza l'impostazione della fase corrente.

0 - 5 sec



2700K

5 - 10 sec



3350K

10 - 15 sec



4000K

LED DI SEGNALEZIONE

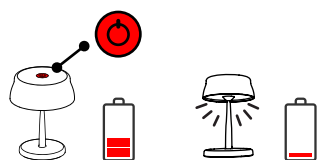

LED ROSSO FISSO

carica della batteria inferiore al 20% si consiglia la ricarica.

Quando la carica è esaurita (1%), la lampada non si accende, ma emette tre flash bianchi di allerta - ricaricare.

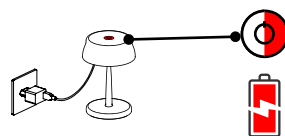

LED ROSSO LAMPEGGIANTE

ricarica in corso.

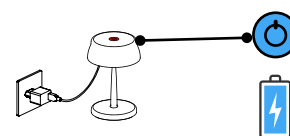

LED BLU FISSO

batteria carica al 100% si consiglia di disconnettere dall'unità di ricarica.

Reset delle impostazioni > RIPRISTINO DELLA CONFIGURAZIONE DI FABBRICA

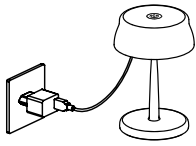

1 Collegare la lampada alla presa di corrente.

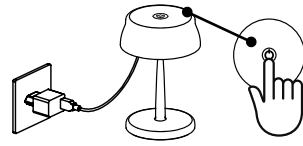

2 Appoggiare il dito sul touch mantenendo la pressione.



3 Scollegare la lampada dalla presa di corrente.

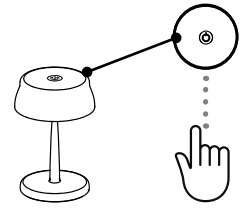

4 Sollevare il dito dal touch.

Istruzioni di montaggio > FISSAGGIO MAGNETICO

INCLUSO
Kit per fissaggio
magnetico
(x 2)

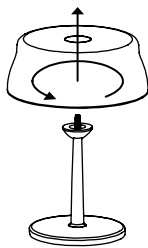

1 Svitare la testa della lampada dal perno filettato.

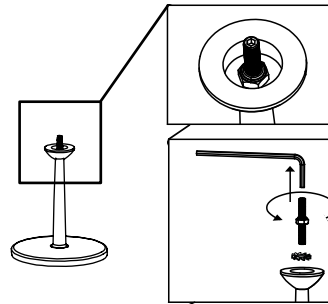

2 Svitare il perno filettato.

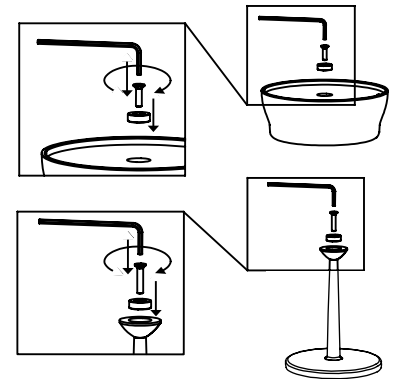

3 Avvitare i magneti e riposizionare la testa sullo stelo.

Istruzioni di montaggio > KIT FISSAGGIO MECCANICO AL TAVOLO

NON INCLUSO

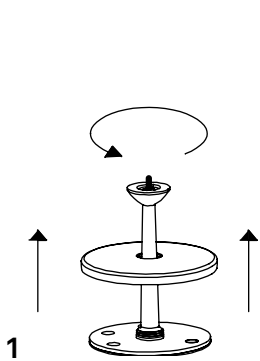

1

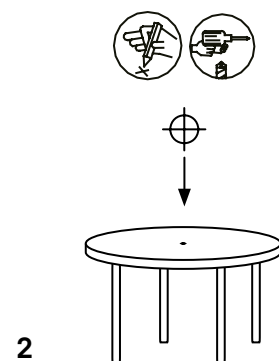

2

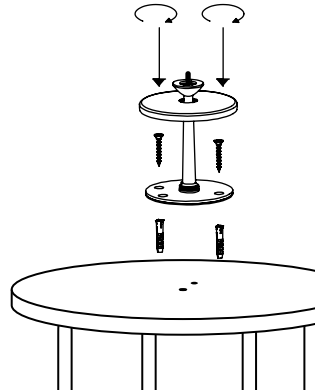

3

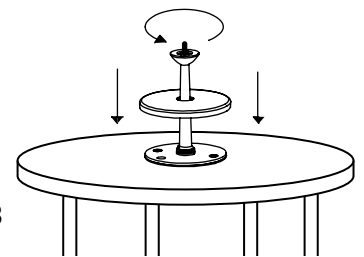

4

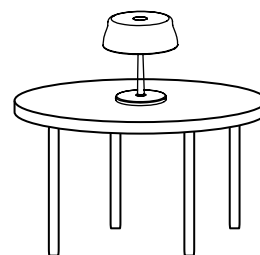
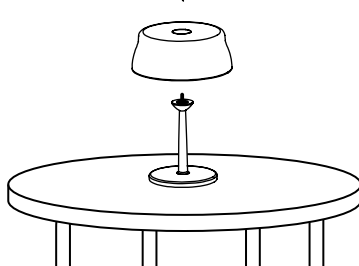



sister light mini

Rechargeable table lamp

LD030603 nodized gold
LD0306R3 anodized copper
LD0306V3 anodized green

LED DIMMER
3W • 250lm - 260lm - 270lm
2700K - 3350K - 4000K
IP65 • CRI>90 • 5Vdc max 2A
Ø 13,2 x h 32,8 x Ø 11,6 cm
Ø 5,2 x h 12,9 x Ø 4,6 in

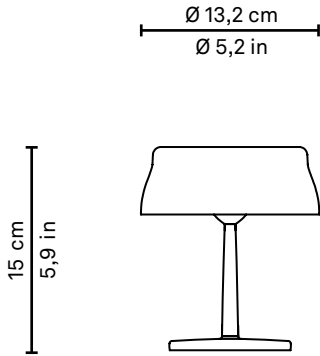



INCLUDED

 Charging cable with USB Type C input

 Magnetic fixing kit x 2

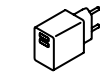
NOT INCLUDED

 **LD0300UC**
Dual USB port power charger

 **LD0340RA**
Multi-socket USB charger (8xUSB)

 **BAT04705506701900**
Replacement battery pack

 **KIT00012007000200**
Replacement LED board



1. Tips for use:

This product is exclusively for lighting purposes and:

A) It must not be exposed to heavy mechanical loads or contamination; **B)** It can be installed and used only after checking the state of the product; check that is not dirty and has not been damaged during storage; **C)** Installation and maintenance must be carried out when the appliance is switched off; **D)** Any alterations to the product, any tampering and any failure to comply with the instructions provided may make the appliance hazardous; **E)** Products with IP65 protection are suitable for outdoor use; **F)** All metal and plastic surfaces should be cleaned with a soft dry cloth; **G)** The company Zafferano shall not be held liable for any damage caused due to its products being assembled in any manner that does not comply with the instructions provided.

2. Technical data:

- Power: 3 W
- Volt: DC 5 V
- Lumen lamp: 2700K 148 lm - 3350K 158 lm - 4000K 166 lm
- LED: HONGLITRONIC 2835 /(8+42 pz) 3 STEP MAC ADAM
- Lithium battery pack included (see section accessories included); for instructions about how to replace the battery pack, please consult the website: www.zafferanoitalia.com. We recommend using an original battery pack as a replacement.
- Standard charge: 1A - 2A (max 2,5A)
- Charge: 1A 10 h - 2A 5 h
- Battery life: 100% 8 h - 60% 13 h - 30% 28 h - 6% 58 h
- Class: III
- Protection rating: IP65
- CRI≥90
- With reference to the UNI EN ISO 9227 standard, the lamp is guaranteed to resist exposure to neutral salt spray (NSS) for 1,500 hours.

3. Charger:

- You can use a charger with Standard-A USB to charge this product.
- **Dual USB port power charger NOT INCLUDED:** INPUT 100-240 V AC - 50/60Hz; OUTPUT DC 5V - 2.1 A.
- To correctly charge the lamp, we recommend that you: 1- Connect the USB cable to the adaptor; 2- Connect the USB cable to the lamp; 3- Put the plug into the electrical socket; 4- When fully charged, disconnect the plug from the electrical socket and remove the USB cable.
- The lamp also operates properly when connected to the mains power supply.
- We recommend using an optional charger and the original cable provided. Alternatively, use a certified cable and a 2A charger.

4. Manufacturer's configuration:

100% LUMINOSITY - 2700K - DIMMER ON - MECHANICAL FIXING

5. Important!

- The support surface for the lamp must not exceed a 15° tilt or it will fall.
- The battery is provided with the following protection functions: short circuit, over discharge, over charge, over current, over voltage.
- To preserve the integrity of the battery, we recommend keeping the charge between minimum 20% and maximum 80%; if the lamp is not used for long periods, it is advisable to regularly charge/discharge the product.
- Please refer to local laws for the proper disposal and recycling of the battery.

INSTRUCTIONS FOR USE

SWITCHING ON / DIMMING / SWITCHING OFF

Quick taps to:

- turn on
- change the brightness
- turn off the lamp

The steps are repeated in a cycle.

When you press and hold the touch button for two seconds, the lamp turns off, memorising the current dimmer setting and proposing it again the next time the lamp is turned on.

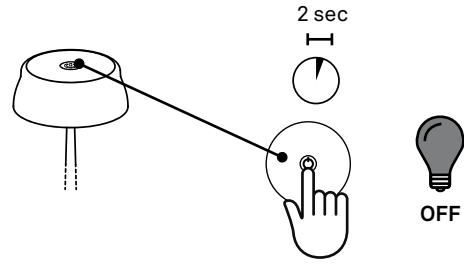
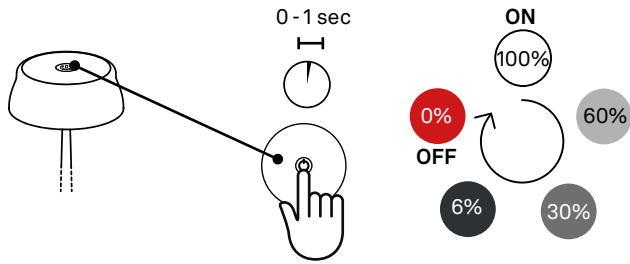

COLOR TEMPERATURE

When the lamp is turned off, press and hold the touch button:

- after 5 seconds it turns on at 2700K
- after 10 seconds it switches to 3350K
- after 15 seconds it switches to 4000K

The steps are repeated in a cycle.

If you release your touch during one of the steps, the lamp memorises the setting of the current step.

0 - 5 sec



2700K

5 - 10 sec



3350K

10 - 15 sec



4000K

INDICATOR LEDS

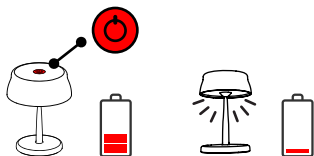

PERMANENT RED LED

the battery charge is lower than 20%, charging is recommended.

When the charge is depleted (1%), the lamp does not switch on but emits three white flashes as an alert to charge

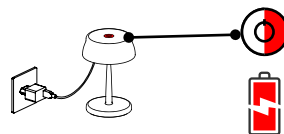

FLASHING RED LED

charging in progress

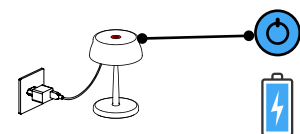

PERMANENT BLUE LED

the battery is 100% charged, disconnection from the power charger is recommended



Reset settings > FACTORY RESET

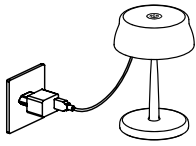

1 Plug the lamp into the electric socket.

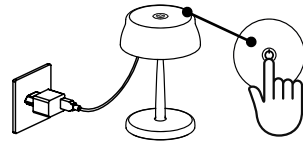

2 Place a finger on the touch sensor and keep it pressed down.



3 Unplug the lamp from the electric socket.

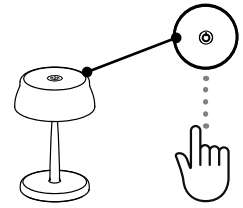

4 Remove your finger from the touch sensor.

Assembly instructions > MAGNETIC FIXING

INCLUDED
Magnetic fixing
kit
(x 2)

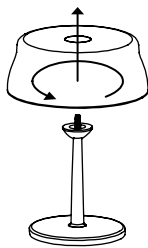

1 Unscrew the top of the lamp from the threaded pin.

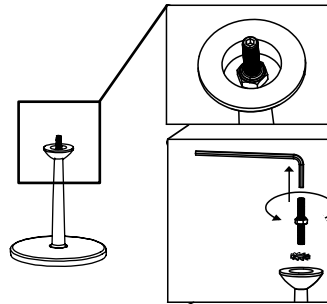

2 Unscrew the threaded pin.

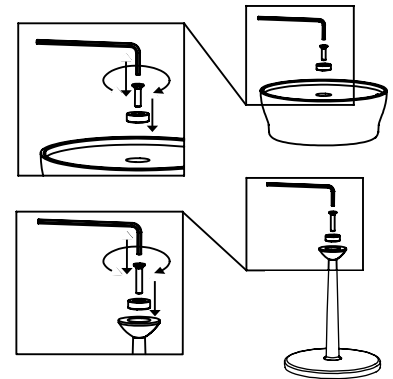

3 Screw in the magnets and reposition the head on the stem.

Assembly instructions > FIXING KIT TO THE TABLE

NOT INCLUDED

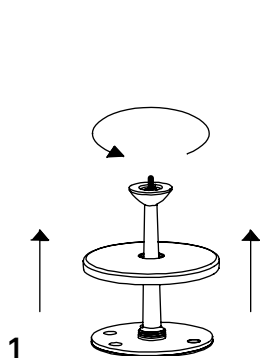
1

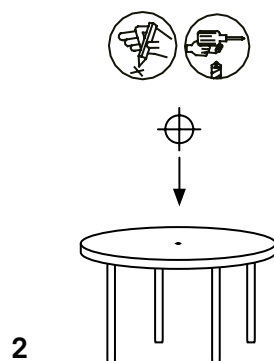

2

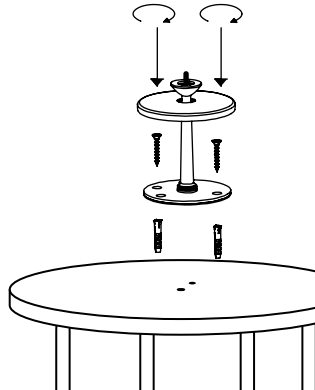

3

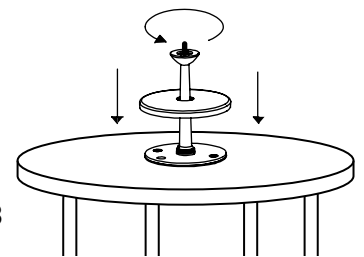

4

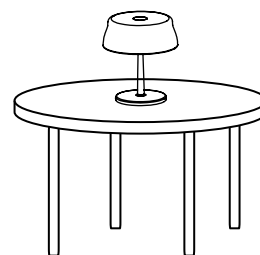
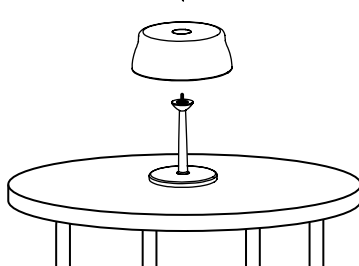

sister light mini

Aufladbare tischlamp

LD030603 eloxiertes Gold
LD0306R3 eloxiertes Kupfer
LD0306V3 eloxiertes Grün

LED DIMMER
3W • 250lm - 260lm - 270lm
2700K - 3350K - 4000K
IP65 • CRI>90 • 5Vdc max 2A
Ø 13,2 x h 32,8 x Ø 11,6 cm
Ø 5,2 x h 12,9 x Ø 4,6 in

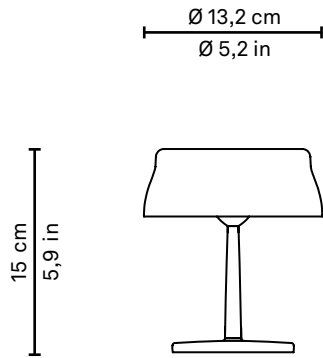

INBEGRIFFEN

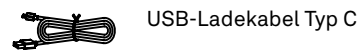

USB-Ladekabel Typ C

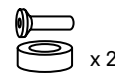

Magnetbefestigungssatz

x 2

NICHT ENTHALTEN



LD0300UC

Ladegerät mit doppeltem USB-Eingang



LD0340RA

Ladegerät (8xUSB)



BAT04705506701900

Ersatzakku



KIT00012007000200

Ersatz-LED-Platine



1. Hinweise zur Verwendung:

Dieses Produkt dient ausschließlich zur Beleuchtung und:

A) Darf keinen starken mechanischen Belastungen oder starken Kontaminationen ausgesetzt werden; **B)** kann nur, nachdem der Zustand des Produkts kontrolliert wurde, installiert und verwendet werden; prüfen, dass es nicht schmutzig ist und während der Lagerung nicht beschädigt wurde; **C)** Das Gerät muss ausgeschaltet, installiert oder gewartet werden; **D)** Durch die Veränderung oder Manipulation des Produkts und die Nichteinhaltung dieser Anweisungen kann das Gerät gefährlich werden; **E)** Produkte mit Schutzgrad 65 (IP65) können im Freien verwendet werden; **F)** Zur Reinigung aller Metall- oder Plastikoberflächen ein trockenes, weiches Tuch verwenden; **G)** Die Firma Zafferano lehnt jede Verantwortung für Schäden ab, die durch eines ihrer Produkte, das nicht gemäß der gelieferten Anweisungen montiert wurde, entstehen.

2. Technische Daten:

- Leistung: 3 W
- Volt: DC 5 V
- Absoluter Lichtstrom: 2700K 148 lm - 3350K 158 lm - 4000K 166 lm
- LED: HONGLITRONIC 2835 / (8+42 pz) 3 STEP MAC ADAM
- Eine Lithiumbatterie ist in der Lieferung enthalten (siehe Abschnitt Zubehör enthalten); zu den Anweisungen zum Auswechseln der Batterie schauen Sie bitte auf die Webseite www.zafferanoitalia.com. Die Batterie sollte nur durch eine Originalbatterie ersetzt werden.
- Standardaufladung: 1A - 2A (max 2,5A)
- Aufladezeit: 5 Std 2A - 10 Std 1A
- Batteriedauer: 100% 8 Std - 60% 13 Std - 30% 28 Std - 6% 58 Std
- Klasse: III
- Schutzgrad: IP65
- CRI ≥ 90
- Unter Bezugnahme auf die Norm DIN EN ISO 9227 hat die Lampe bei der neutralen Salzsprühnebelprüfung (NSS) eine Korrosionsbeständigkeit von 1500 Stunden.

3. Ladegerät:

- Um das Produkt aufzuladen, können Aufladegeräte mit Mikro verwendet werden.
- Ladegerät mit doppeltem USB-Eingang NICHT ENTHALTEN: INPUT 100-240 V AC - 50/60Hz; OUTPUT DC 5V - 2.1 A.
- Um die Lampe korrekt aufzuladen, sollte man: 1- Das USB-Kabel an den Adapter anschließen; 2-Das USB-Kabel an die Lampe anschließen; 3- Den Stecker in die Steckdose stecken; 4- Wenn die Lampe aufgeladen ist, den Stecker aus der Steckdose ziehen und das USB-Kabel von der Lampe trennen.
- Die Lampe funktioniert auch mit Stromanschluss korrekt.
- Wir raten dazu, das optionale Ladegerät und das mitgelieferte Kabel zu verwenden. Als Alternative ein zertifiziertes 2A-Kabel und Ladegerät verwenden.

4. Werkskonfiguration:

HELLIGKEIT 100% - K 2700 - DIMMER AN - MECHANISCHE BEFESTIGUNG

5. Achtung:

- Die Standfläche der Lampe darf keine höhere Neigung als 15° besitzen, sonst fällt diese um.
- Die Batterie ist abgesichert gegen: Kurzschluss, Überentlastung, Überbelastung, Überstrom, Überspannung.
- Um die Lebensdauer des Akkus zu erhalten, sollte sein Ladestand zwischen 20 und 80 Prozent liegen. Wenn die Lampe lange Zeit nicht benutzt wird, sollte der Akku regelmäßig ent- und wieder aufgeladen werden.
- Die Batterie muss entsprechend der geltenden, lokalen Vorschriften zur Abfallentsorgung und -wiederverwertung behandelt werden.



GEBRAUCHSANWEISUNG

EIN- / DIMMEN / AUSSCHALTEN

Kurz drücken, zum:

- Einschalten
- Helligkeit anpassen
- Gerät ausschalten

Die Aufeinanderfolge ist zyklisch.

Wenn Sie den Berührungsschalter zwei Sekunden lang gedrückt halten, schaltet sich die Lampe aus, speichert die aktuelle Dimmstufe und geht beim nächsten Einschalten mit dieser wieder an.

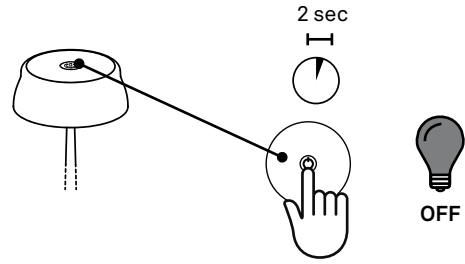
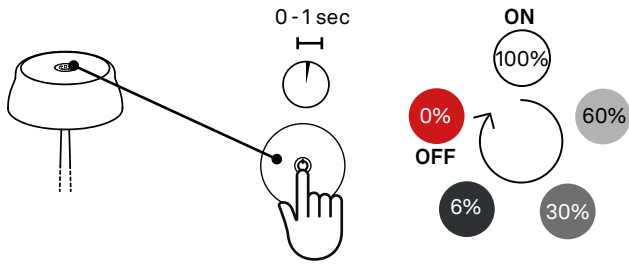

FARBTEMPERATUR

Halten Sie den Berührungsschalter bei ausgeschalteter Lampe gedrückt:

- nach 5 Sekunden geht sie bei 2700K an
- nach 10 Sekunden schaltet sie auf 3350K
- nach 15 Sekunden schaltet sie auf 4000K

Die Aufeinanderfolge ist zyklisch.

Wird der Berührungsschalter während einer der Phasen losgelassen, speichert die Lampe die aktuelle Einstellung.

0 - 5 sec



2700K

5 - 10 sec



3350K

10 - 15 sec



4000K

LEDANZEIGE

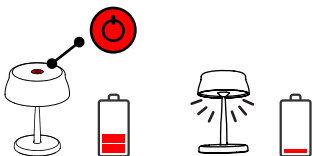

LED LEUCHTET ROT

Batterieladung unter 20%. Die Batterie sollte aufgeladen werden

Wenn die Batterie entladen ist (1%), geht die Lampe nicht an, blinkt aber dreimal weiß auf-aufladen.

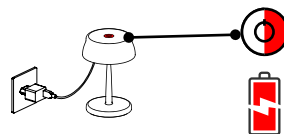

LED BLINKT ROT

Wird aufgeladen.

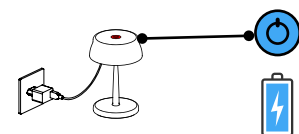

LED LEUCHTET BLAU

Batterie zu 100% aufgeladen.

Die Batterie vom Ladegerät trennen.

Reset der einstellungen > WIEDERHERSTELLUNG DER WERKSKONFIGURATION

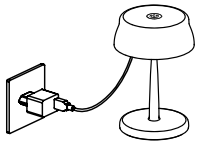

1 Den Stecker der Lampe in die Steckdose stecken.

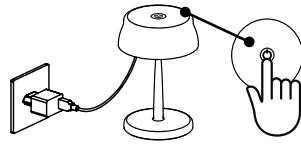

2 Mit dem Finger auf das Touchfeld drücken.

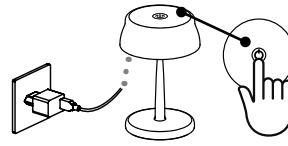

3 Den Stecker der Lampe aus der Steckdose ziehen.

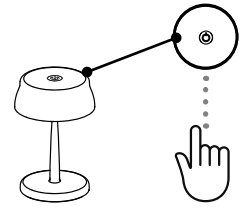

4 Den Finger vom Touchfeld nehmen.

Montageanleitung > MAGNETISCHE BEFESTIGUNG

INBEGRIFFEN
Magnetbefestigungssatz
(x 2)

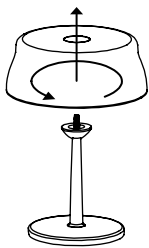

1 Den Lampenkopf vom Gewindesttiff schrauben.

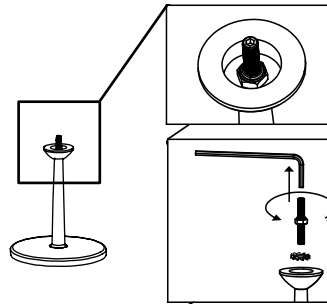

2 Den Gewindesttiff schrauben

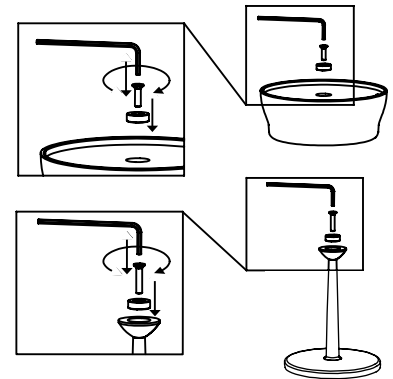

3 Magneten anschrauben und neu positionieren der Kopf am Stiel.

Montageanleitung > SET FÜR BEFESTIGUNG AM TISCH

NICHT ENTHALTEN

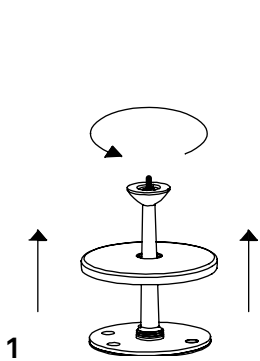

1

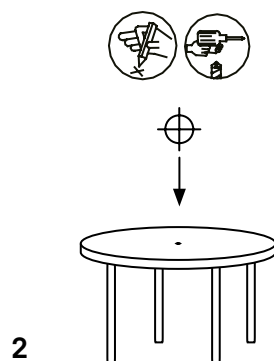

2

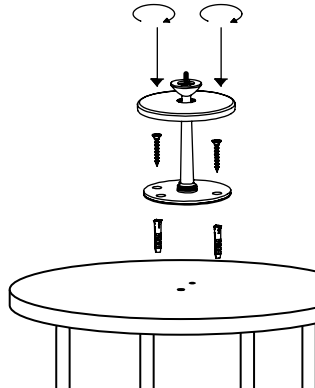

3

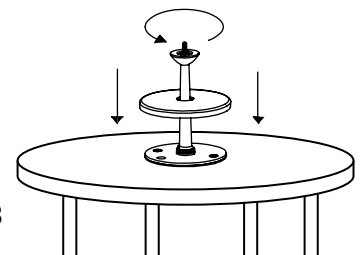

4

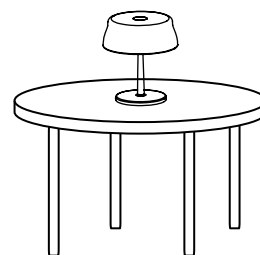
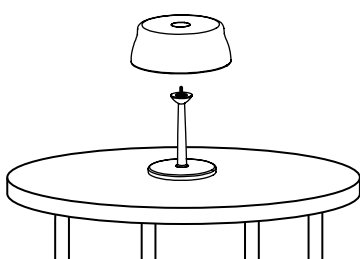



sister light mini

lampe de table rechargeable

LD030603 or anodisé
LD0306R3 cuivre anodisé
LD0306V3 vert anodisé

LED DIMMER
3W • 250lm - 260lm - 270lm
2700K - 3350K - 4000K
IP65 • CRI>90 • 5Vdc max 2A
Ø 13,2 x h 32,8 x Ø 11,6 cm
Ø 5,2 x h 12,9 x Ø 4,6 in

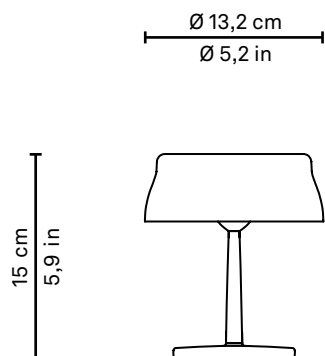

INCLUS

 Câble de recharge avec entrée USB type C

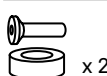
 x 2
Kit pour fixation magnétique

NON INCLUS

 **LD0300UC**
Chargeur de batteries à double entrée USB

 **LD0340RA**
Station de charge multiple (8xUSB)

 **BAT04705506701900**
Batterie de remplacement

 **KIT00012007000200**
Carte LED de remplacement



1. Conseils d'utilisation:

Ce produit sert exclusivement pour éclairer et:

A) Ne doit pas être exposé à de lourdes charges mécaniques ou à de fortes contaminations; **B)** Peut être installé et utilisé uniquement après avoir contrôlé les conditions du produit; vérifier s'il n'est pas sale et s'il n'a pas subi de dommages durant le stockage; **C)** L'installation et l'entretien doivent être effectués lorsque l'appareil est éteint; **D)** Les modifications ou les altérations du produit et le non-respect des indications fournies peuvent rendre l'appareil dangereux; **E)** Les produits avec un degré de protection 65 (IP65) sont adaptés à une utilisation externe; **F)** Pour le nettoyage de toutes les surfaces métalliques et plastiques, utiliser un chiffon souple et sec; **G)** La société Zafferano décline toute responsabilité pour les dommages provoqués par un produit monté de manière non conforme par rapport aux instructions.

2. Données techniques:

- Puissance: 3 W
- Voltage: DC 5 V
- Flux lumineux: 2700K 250 lm - 3350K 260 lm - 4000K 270 lm
- LED: HONGLITRONIC 2835 /(8+42 pz) 3 STEP MAC ADAM
- Batteries au lithium inclus (voir rubrique accessoires inclus); visiter le site www.zafferanoitalia.com pour avoir les indications de son remplacement. Pour le remplacement, il est recommandé l'usage d'un assemblage-batteries original.
- Standard recharge: 1A - 2A (max 2,5A)
- Recharge: 5 h 2A - 10 h 1A
- Durée de la batterie: 100% 8 h - 60% 13 h - 30% 28 h - 6% 58 h
- Classe: III
- Degré de protection: IP65
- CRI≥90
- Conformément à la norme UNI EN ISO 9227, la résistance de la lampe à l'exposition au brouillard salin neutre (NSS) est garantie pendant 1500 heures.

3. Chargeur de batterie:

- Pour recharger le produit, il est possible d'utiliser le chargeur de batterie USB standard A.
- Chargeur de batteries à double entrée USB - NON INCLUS: INPUT 100-240 V AC - 50/60Hz; OUTPUT DC 5V - 2.1 A.
- Pour recharger la lampe correctement, il est conseillé de: 1- brancher le câble USB à l'adaptateur; 2- brancher le câble USB à la lampe; 3- insérer la fiche dans la prise de courant; 4- lorsque la lampe est rechargée, retirer la fiche de la prise de courant et enlever le câble USB.
- La lampe fonctionne correctement, même si elle est raccordée au courant.
- Il est recommandé l'usage du chargeur optionnel et du câble original en dotation. Comme alternative, utiliser un câble et un chargeur certifiés à 2A.

4. Configuration d'usine:

LUMINOSITE 100% - K 2700 - DIMMER ON - FIXATION MÉCANIQUE

5. Attention:

- Le plan d'appui de la lampe ne doit pas dépasser 15° d'inclinaison, sinon elle risque de tomber.
- La batterie est fournie avec les protections suivantes: court-circuit, sous-charge, surcharge, surintensité, surtension.
- Pour préserver l'intégrité de la batterie, il est conseillé de maintenir la charge entre 20% minimum et 80% maximum; si la lampe n'est pas utilisée pendant de longues périodes, il est conseillé de procéder périodiquement à un cycle de charge/décharge du produit.
- Se référer aux lois locales pour une élimination correcte et le recyclage de la batterie.

MODE D'EMPLOI

ALLUMER / VARIER / ÉTEINDRE

Toucher rapidement pour :

- allumer
- changer la luminosité
- éteindre le dispositif

La répétition des niveaux est cyclique.

En appuyant sur le touch pendant deux secondes, la lampe s'éteint en mémorisant le niveau de réglage dimmer courant et en le reproposant lors du prochain allumage.

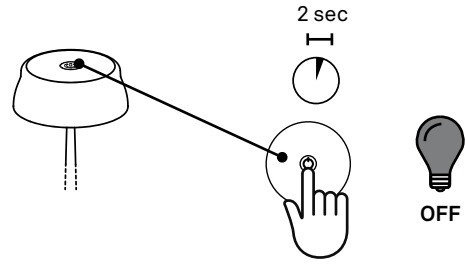
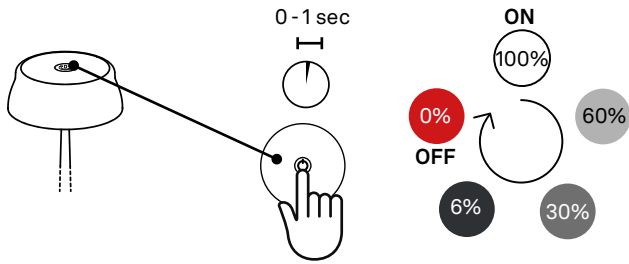

TEMPÉRATURE DE COULEUR

Lorsque la lampe est éteinte, appuyer sur le touch:

- après 5 secondes, elle s'allume à 2700K
- après 10 secondes, elle passe à 3350K
- après 15 secondes, elle passe à 4000K

La répétition des niveaux est cyclique.

En arrêtant de toucher pendant l'une des phases, la lampe mémorise le réglage de la phase courante.

0 - 5 sec



2700K

5 - 10 sec



3350K

10 - 15 sec



4000K

LED DE SIGNALISATION

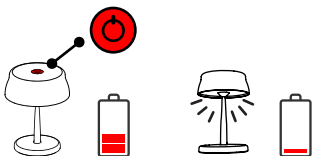

LED ROUGE FIXE

charge de la batterie inférieure à 20%, nous vous conseillons de la recharger. Lorsque la charge est épuisée (1%), la lampe ne s'allume pas, mais elle émet trois flashes blanc d'alarme.

- recharger.

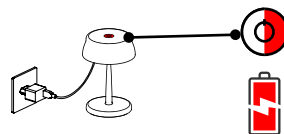

LED ROUGE CLIGNOTANTE
recharge en cours.

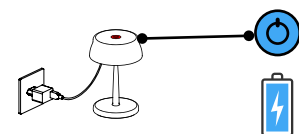

LED BLEUE FIXE

batterie rechargée à 100%, nous vous conseillons de la débrancher de l'unité de recharge.



Réinstallation des paramètres > RÉTABLISSEMENT DE LA CONFIGURATION D'USINE

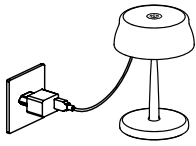

1
Connecter la lampe à la prise de courant.

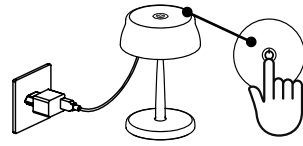

2
Toucher la fonctionne Touch en maintenant la pression.



3
Débrancher la lampe da la prise de courant.

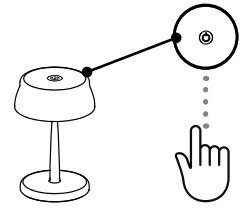

4
Lever le doigt de la fonctionne Touch.

Notice de montage > FIXATION MAGNÉTIQUE

INCLUS
Kit pour fixation magnétique (x 2)

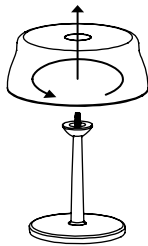

1
Dévisser la tête de lampe de la tige filetée.

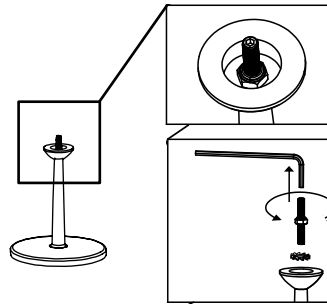

2
Dévisser la tige filetée.

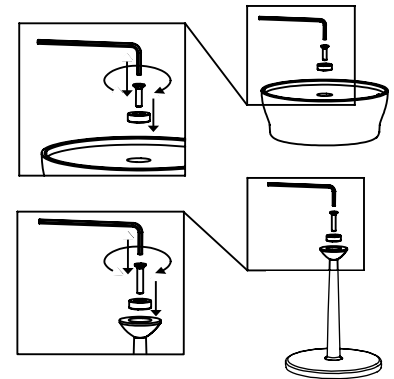

3
Visser les aimants et repositionner la tête sur la tige.

Notice de montage > KIT POUR FIXATION À LA TABLE

NON INCLUS

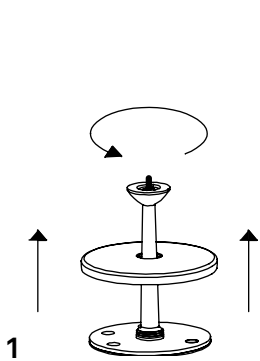

1

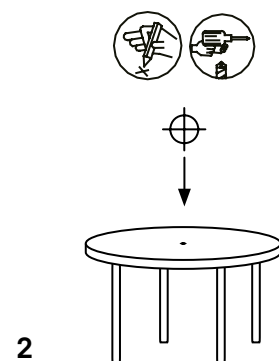

2

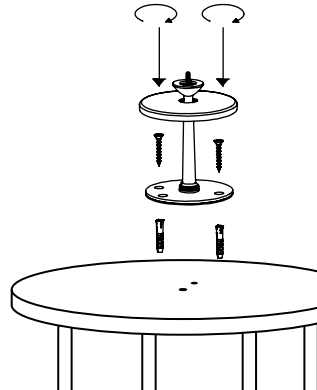

3

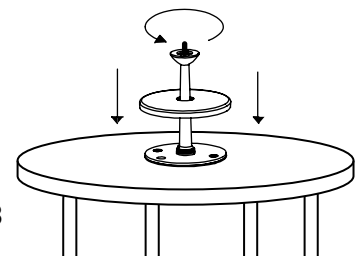

4

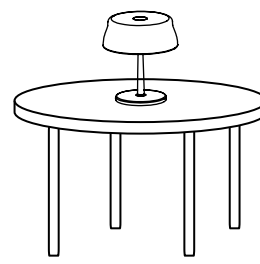
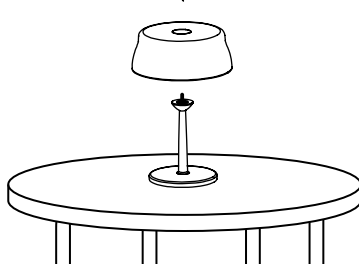

sister light mini

lámpara de mesa recargable

LD030603 oro anodizado
LD0306R3 cobre anodizado
LD0306V3 verde anodizado

LED DIMMER
3W • 250lm - 260lm - 270lm
2700K - 3350K - 4000K
IP65 • CRI>90 • 5Vdc max 2A
Ø 13,2 x h 32,8 x Ø 11,6 cm
Ø 5,2 x h 12,9 x Ø 4,6 in

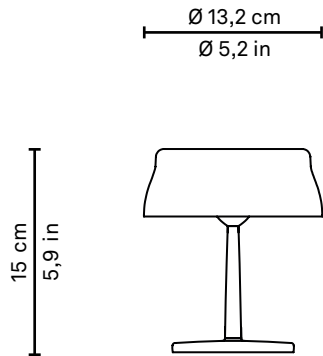

INCLUIDO

Cable de recarga con entrada USB Tipo C

kit para fijación magnética x 2

NO INCLUIDO

LD0300UC
Cargador de batería con doble entrada USB

LD0340RA
Cargador múltiple USB (8xUSB)

BAT04705506701900
Paquete batería sustitutiva

KIT00012007000200
Tablero LED de repuesto



1. Consejos de uso:

Este producto debe utilizarse exclusivamente para iluminación y:

A) No debe ser expuesto a cargas mecánicas pesadas o contaminaciones fuertes; **B)** solo puede ser instalado y utilizado previo control de las condiciones del producto; verificar que no resulte estar sucio y no ha haya sido dañado durante el almacenamiento; **C)** la instalación y el mantenimiento deben realizarse con el aparato apagado; **D)** las modificaciones o las manipulaciones del producto y el incumplimiento de las indicaciones mostradas pueden hacer que el aparato sea peligroso; **E)** los productos con grado de protección 65 (IP65) son adecuados para uso externo; **F)** para la limpieza de todas las superficies metálicas y de plástico utilizar un paño suave y seco; **G)** La empresa Zafferano declina cualquier responsabilidad por los daños causados por un producto suyo montado de manera no conforme con las instrucciones.

2. Datos técnicos:

- Potencia: 3 W
- Voltios: DC 5 V
- Flujo luminoso: 2700K 250 lm - 3350K 260 lm - 4000K 270 lm
- LED: HONGLITRONIC 2835 / (8+42 pz) 3 STEP MAC ADAM
- Batería de litio incluida (ver sección accesorios incluidos); para las instrucciones de sustitución de la batería consulte el sitio web www.zafferanoitalia.com. Para la sustitución se recomienda el uso de una batería original.
- Recarga standard: 1A - 2A (max 2,5A)
- Recarga: 5 h 2A - 10 h 1A
- Duración de la batería: 100% 8 h - 60% 13 h - 30% 28 h - 6% 58 h
- Clase: III
- Grado de protección: IP65
- CRI≥90
- En referencia a la norma UNI EN ISO 9227, la resistencia de la lampada a la exposición con niebla salina neutra (NSS) está garantizada durante 1500 horas.

3. Cargador de baterías:

- Para cargar el producto es posible usar el cargador de baterías USB estándar A.
- Cargador de batería con doble entrada USB – NO INCLUIDO: INPUT 100-240 V AC - 50/60Hz; OUTPUT DC 5V - 2.1 A.
- Para una carga correcta de la lámpara se aconseja: 1- conecte el cable USB al adaptador; 2-conecte el cable USB a la lámpara; 3- conecte el enchufe a la toma de corriente; 4- una vez completada la carga, retire el enchufe de la toma eléctrica y retire el cable USB.
- La lámpara funciona correctamente, aunque esté conectada a la corriente.
- Se aconseja el uso del cargador opcional y del cable en dotación original. Como alternativa, utilizar un cable y cargador de 2A certificados.

4. Configuración de fábrica:

- BRILLO 100% - K 2700 - OSCURECEDOR ON - FIJACIÓN MECÁNICA

5. Atención:

- La superficie de apoyo de la lámpara no debe superar los 15° de inclinación para evitar su caída.
- La batería se entrega con las siguientes protecciones: cortocircuito, sobredescarga, sobrecarga, sobrecorriente, sobretensión.
- Para preservar la integridad de la batería se aconseja mantener la carga entre un mínimo del 20% y un máximo del 80%; si la lámpara no se utiliza durante periodos prolongados se aconseja realizar periódicamente un ciclo de carga/descarga del producto.
- Remítase a las normativas de ley locales para una eliminación y reciclaje correctos de la batería.



INSTRUCCIONES DE USO

ENCENDIDO / ATENUACIÓN / APAGADO

Toques rápidos para:

- encender
- cambiar la luminosidad
- apagar el dispositivo

La repetición de los pasos es cíclica.

Manteniendo apretado el toque durante dos segundos, la lámpara se apaga memorizando el paso de atenuación actual y proponiéndolo otra vez en el siguiente encendido.

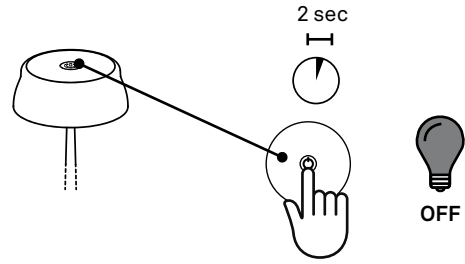
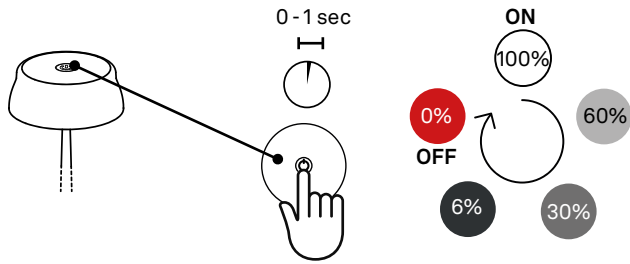

TEMPERATURA DEL COLOR

Con la lámpara apagada, mantener apretado el toque:

- después de 5 segundos se enciende a 2700K
 - después de 10 segundos pasa a 3350K
 - después de 15 segundos pasa a 4000K
- La repetición de los pasos es cíclica.

Interrumpiendo el paso durante una de las fases, la lámpara memoriza la configuración de la fase actual.

0 - 5 sec



2700K

5 - 10 sec



3350K

10 - 15 sec



4000K

LED DE SEÑALIZACIÓN

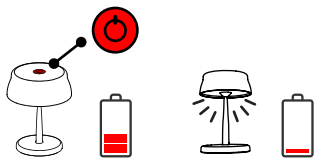

LED ROJO FIJO

carga de la batería inferior al 20%, se recomienda recargar

Cuando la carga está agotada (1%), la lámpara no se enciende, sino que emite tres destellos blancos de alerta - recargar.

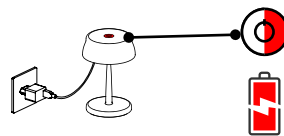

LED ROJO INTERMITENTE

recarga en curso.

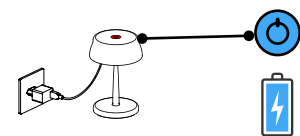

LED AZUL FIJO

batería cargada al 100%, es aconsejable desconectar de la unidad de recarga.

Restablecimiento de las configuraciones de fábrica

-
- 1 Collegare la lampada alla presa di corrente.
 - 2 Appoggiare il dito sul touch mantenendo la pressione.
 - 3 Scollegare la lampada dalla presa di corrente.
 - 4 Sollevare il dito dal touch.

Instrucciones de montaje > FIJACIÓN MAGNÉTICA

INCLUIDO
kit para fijación
magnética
(x 2)

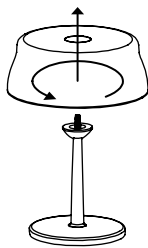

- 1 Quitar los imanes

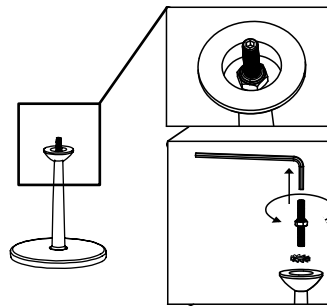

- 2 Atornillar el perno roscado

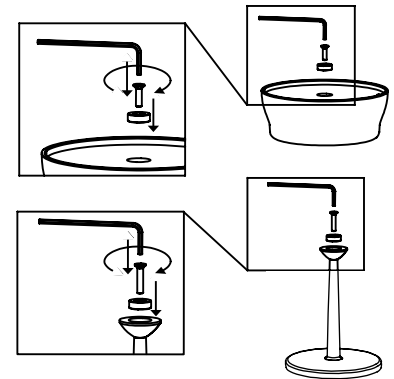

- 3 Apretar el cabezal de la lámpara en el perno roscado

Instrucciones de montaje > KIT DE FIJACIÓN PARA MESA

NO INCLUIDO

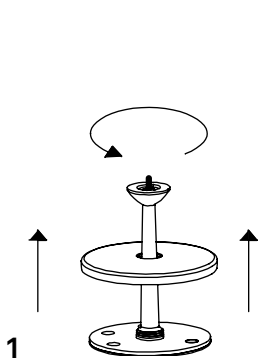

1

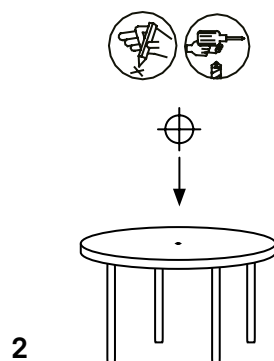

2

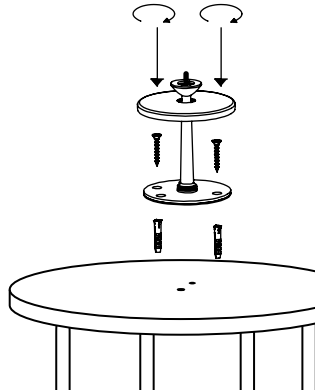

3

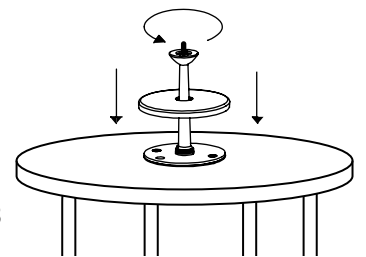

4

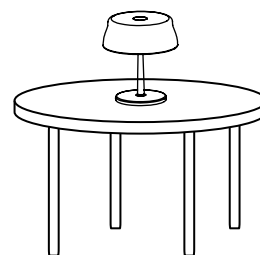
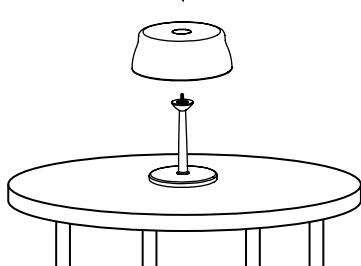

ACCESSORI INCLUSI E NON INCLUSI/ INCLUDEDEN AND NOT INCLUDED ACCESSORIES / ZUBEHÖR INKLUSIVE UND NICHT INKLUSIVE / ACCESSOIRES INCLUS ET NON INCLUS / ACCESORIOS INCLUIDOS Y NO INCLUIDOS

INCLUSI / INCLUDED / BEILIEGEND / INCLUS / INCLUIDO

- (IT) Cavo di ricarica con entrata USB tipo C
- (UK) Charging cable with USB Type C input
- (DE) USB-Ladekabel Typ C
- (FR) Câble de recharge avec entrée USB type C
- (ES) Cable de recarga con entrada USB Tipo C

INPUT: 5Vdc max 1A
OUTPUT: 5Vdc max 1A



- (IT) Kit per fissaggio magnetico
- (UK) Magnetic fixing kit
- (DE) Magnetbefestigungssatz
- (FR) Kit pour fixation magnétique
- (ES) kit para fijación magnética



NON INCLUSI / NOT INCLUDED / NICHT ENTHALTEN / NON INCLUS / NO INCLUIDO

LD0300UC

- (IT) Carica batterie con doppia entrata USB
- (UK) Dual USB port power charger
- (DE) Ladegerät mit doppeltem USB-Eingang
- (FR) Chargeur de batteries à double entrée USB
- (ES) Cargador de batería con doble entrada USB

INPUT: 100-240V
50/60Hz
OUTPUT: 5Vdc max 2A



LD0340RA

- (IT) Caricatore multipresa USB (8xUSB)
- (UK) Multi-socket USB charger (8xUSB)
- (DE) Ladegerät (8xUSB)
- (FR) Station de charge multiple (8xUSB)
- (ES) Cargador múltiple USB (8xUSB)

INPUT: AC100-240V
50/60Hz
OUTPUT: 5Vdc max 8A

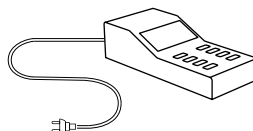

BAT04705506701900

- (IT) Pacco batteria sostitutiva
- (UK) Replacement battery pack
- (DE) Ersatzakku
- (FR) Batterie de remplacement
- (ES) Paquete batería sustitutiva

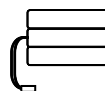

Scansiona il codice QR per vedere come sostituire le batterie esauste della tua lampada.
Scan the QR code to see how to replace the exhausted batteries of your lamp.
Scannen Sie den QR-Code, um herauszufinden, wie Sie die verbrauchten Batterien Ihrer Lampe ersetzen können.
Scannez le code QR pour voir comment remplacer les piles épuisées de votre lampe.
Escanee el código QR para ver cómo reemplazar las baterías agotadas de su lámpara.

KIT00012007000200

- (IT) Scheda LED sostitutiva
- (UK) Replacement LED board
- (DE) Ersatz-LED-Platine
- (FR) Carte LED de remplacement
- (ES) Tablero LED de repuesto



Scansiona il codice QR per vedere come sostituire la scheda LED esausta della tua lampada.
Scan the QR code to see how to replace the LED board of your lamp.
Scannen Sie den QR-Code, um herauszufinden, wie Die Lampen-LED-Platine kann ausgetauscht werden.
Scannez le code QR pour voir comment remplacer la carte LED de la lampe.
Escanee el código QR para ver cómo reemplazar la placa LED de la lámpara.

MANUTENZIONE BATTERIE RICARICABILI / RECHARGEABLE BATTERY MAINTENANCE / WARTUNG DES AKKUS / ENTRETIEN DE LA BATTERIE RECHARGEABLE / MANTENIMIENTO DE BATERÍA RECARGABLE



Le batterie ricaricabili con il loro utilizzo sono soggette ad usura. La vita delle batterie, il cui standard è di circa 450 ricariche, può essere ridotta da alcuni fattori come:

- ① la modalità non corretta di ricarica (la lampada va ricaricata quando è scarica: circa il 10% della sua autonomia residua);
- ② lunghi periodi di stazionamento senza utilizzo;
- ③ lunghi periodi di stazionamento su base di ricarica in tensione anche se la lampada risulta carica;
- ④ l'utilizzo di accessori non originali per la ricarica;

⑤ l'esposizione del prodotto a temperature molto alte o molto fredde. Quando le lampade non si ricaricano più o l'autonomia dopo la ricarica risulta molto ridotta, le batterie devono essere sostituite. I ricambi delle lampade ricaricabili Zafferano sono disponibili a catalogo e identificati con apposito codice. La garanzia sulle batterie è valida solo per difetti di fabbricazione, che si possono verificare dopo il primo utilizzo.



All rechargeable batteries are subject to wear when used. The life of batteries, which can generally be recharged 450 times, may be reduced by certain factors:

- ① incorrect recharging mode (the lamp must be recharged when it is flat: about 10% of its remaining autonomy);
- ② when left unused for a long time;
- ③ when left for a long time on a live recharging base even if the lamp is recharged;
- ④ when non-original accessories are used for recharging;

⑤ when the product is exposed to very high or very low temperatures. When the lamps no longer recharge or their autonomy after recharging is very short, the batteries must be replaced. Spare parts for Zafferano rechargeable lamps can be found in the catalogue and identified by a special code. The warranty for batteries is only valid for manufacturing defects, which may occur after initial use.



Wiederaufladbare Akkus unterliegen durch ihren Gebrauch Verschleiß. Die Lebensdauer der Akkus, deren Standard bei ca. 450 Aufladungen liegt, kann durch bestimmte Faktoren verkürzt werden, z. B.:

- ① falscher Auflademodus (die Lampe sollte aufgeladen werden, wenn sie entladen ist: bei ca. 10 % ihrer verbleibenden Ladung);
- ② langes Lagern ohne Nutzung;
- ③ langes Stehen auf der stromführenden Ladestation, auch wenn die Lampe aufgeladen ist;

④ Verwendung von nicht Original-Ladestationen;
⑤ das Produkt sehr hohen oder sehr kalten Temperaturen auszusetzen. Wenn sich die Lampen nicht mehr aufladen lassen oder die Autonomie nach dem Aufladen stark reduziert ist, müssen die Akkus ersetzt werden. Ersatzteile für Zafferano-Akkuleuchten sind im Katalog erhältlich und mit dem entsprechenden Code gekennzeichnet. Die Garantie auf die Akkus gilt nur bei Produktionsfehlern, die nach dem ersten Gebrauch auftreten können.



Les batteries rechargeables sont sujettes à l'usure à la suite de leur utilisation. La durée de vie des batteries, dont le standard est d'environ 450 cycles de charge, peut être réduite par certains facteurs comme:

- ① une modalité de charge incorrecte (la lampe doit être rechargée lorsqu'elle est déchargée: environ 10% de son autonomie résiduelle);
- ② de longues périodes de pause sans utilisation;
- ③ de longues périodes de pause sur la station de charge sous tension, même si la lampe est rechargée;
- ④ l'utilisation d'accessoires non originaux pour la

charge;
⑤ l'exposition du produit à des températures très élevées ou très basses. Les batteries doivent être remplacées lorsque les lampes ne se rechargent plus ou bien lorsque l'autonomie est très réduite après le cycle de charge. Les pièces de rechange des lampes rechargeables Zafferano sont disponibles dans le catalogue et identifiées par un code spécifique. La garantie sur les batteries est valable uniquement pour les défauts de fabrication constatés après leur première utilisation.



Las baterías recargables, con su uso, están sujetas a desgaste. La vida de las baterías, cuya duración es de unas 450 recargas, puede verse reducida por factores tales como:

- ① una modalidad de carga incorrecta (la lámpara se recarga cuando está descargada: aproximadamente el 10% de su autonomía restante);
- ② periodos prolongados sin usarla;
- ③ periodos prolongados colocada en la base de carga en tensión, incluso si la lámpara resulta estar cargada;
- ④ el uso de accesorios no originales para la carga;

⑤ la exposición del producto a temperaturas muy altas o muy bajas. Cuando las lámparas ya no se recargan o la autonomía después de la recarga resulta verse muy reducida, las baterías deben ser sustituidas. Los recambios de las lámparas recargables Zafferano están disponibles en el catálogo e identificados con el código correspondiente. La garantía de las baterías sólo es válida en caso de defectos de fabricación que puedan ocurrir después del primer uso.

zafferano
LAMPES-À-PORTER



Zafferano srl

Viale dell'Industria, 26
31055 - Quinto di Treviso - Italia
T +39 0422 470507
F +39 0422 470400
lighting@zafferanoitalia.com

C.F 03420190260 - P.IVA IT 03305480273
REA di TV n. 330102

zafferanoitalia.com