

# How to Install DSP Switch on 2011-2016 Duramax LML

## Tools Needed for Installation:

- Flashlight
- Flathead Screwdriver
- Side Cutters
- 5ft of wire to fish the switch wires through the firewall
- Zip Ties
- Electrical Tape
- 10mm 3/8 Socket
- 13mm 3/8 Deep Socket
- 1/16" Drill Bit
- Unibit #1 or 3/8 Drill Bit
- 1/8" Drill Bit

## Installing the Switch

1. Pull the hood release and open the hood of the truck. Disconnect both negative cables from both batteries.
2. Locate the ECM (Driver side between the power steering reservoir and the battery). Please allow the truck to cool down before proceeding to the next step.



*LML DSP Switch Installation*

3. Remove the plastic protection cover by applying pressure to the tabs and sliding it out.

4. Looking down on the ECM from the top side on the driver side of the engine remove the ECM Plug closest to the fire wall (J3 Gray Plug). You don't have to but I've found it easiest to remove all three of the harness plugs from the ECM to be able to remove the Gray plug closest to the firewall.

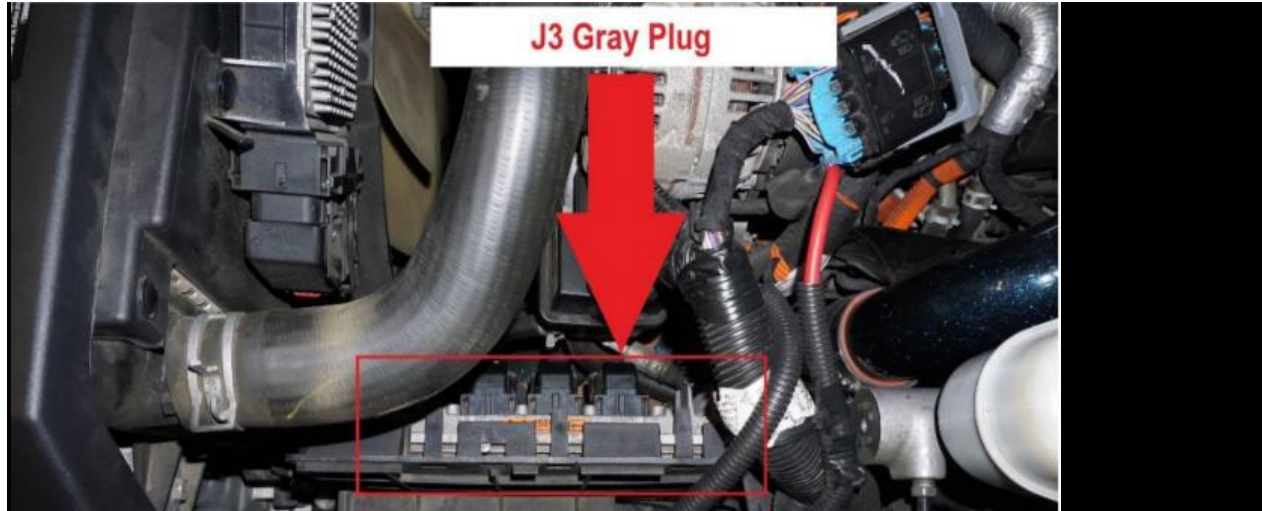

*LML DSP Switch Installation*

5. To disconnect the plugs from the ECM it will not require any special tools. Slide the red lock tab up and apply pressure to the middle of the plug (you might hear a click indicating that it has released). Pulling up on the release lever.

6. Now that that all 3 plugs are disconnected from the ECM pull the connectors plugs closer to allow easy access for the following steps. (I've found it easier to push the gray and black ECM connector plugs under the power steering lines and pull them up by the hot side intercooler pipe)

7. Set the plugs to the side while using your 5ft of metal wire to fish through the firewall. (We use the hood latch release cable hole to fish the wire through to get inside the cab. Pushing the hood latch release cable grommet in using your fingers will allow for enough room to run your wire through the firewall into the driver's floor board. A flash light will be handy. Also we removed the fender support bracket for easier access)



*LML DSP Installation*

8. Now that the wire is in the driver's floor board attach the yellow and black wires from the switch to the wire that you used to fish through the firewall. (I prefer using electrical tape to attach the yellow and black wires)

9. With the yellow and black wires attached to the wire that was run through the firewall, pull the wire back into the engine bay. (Be very careful when pulling these wires through the firewall – if they feel like they are hung up go back to the drivers floor board and make sure they aren't tangled with any of the other components)

10. With the wires pulled through the firewall leaving the switch inside the cab, undo the electrical tape to the yellow and black wires and remove any residue from the pins. Examine the pins to make sure they are not damaged.

11. Take the black wire loom and slide it over the yellow and black wires. (Slide the wire loom all the way into the cab. Using the electrical tape, tape the wire loom to the yellow and black wires. Leave about 8-10 inches of wire exposed)



*LML DSP Switch Installation*

12. Place the wire loom and wires to the side.

13. Locate the gray ECM plug and remove the zip tie holding the top cover. Remove the cap by lifting the 2 ears on either side and lifting up. (Place the black wire cover cap in a safe place out of the way)

**remove zip tie  
and lift the 2 ears  
on either side**



*LML DSP Switch Installation*

14. With the gray ECM connector in your hand use a pick/knife/flathead screwdriver to pry the gray cover off the bottom of the ECM connector. (Be very gentle as they can break very easy. Place the gray cover cap in a safe place out of the way)

**follow step #13**

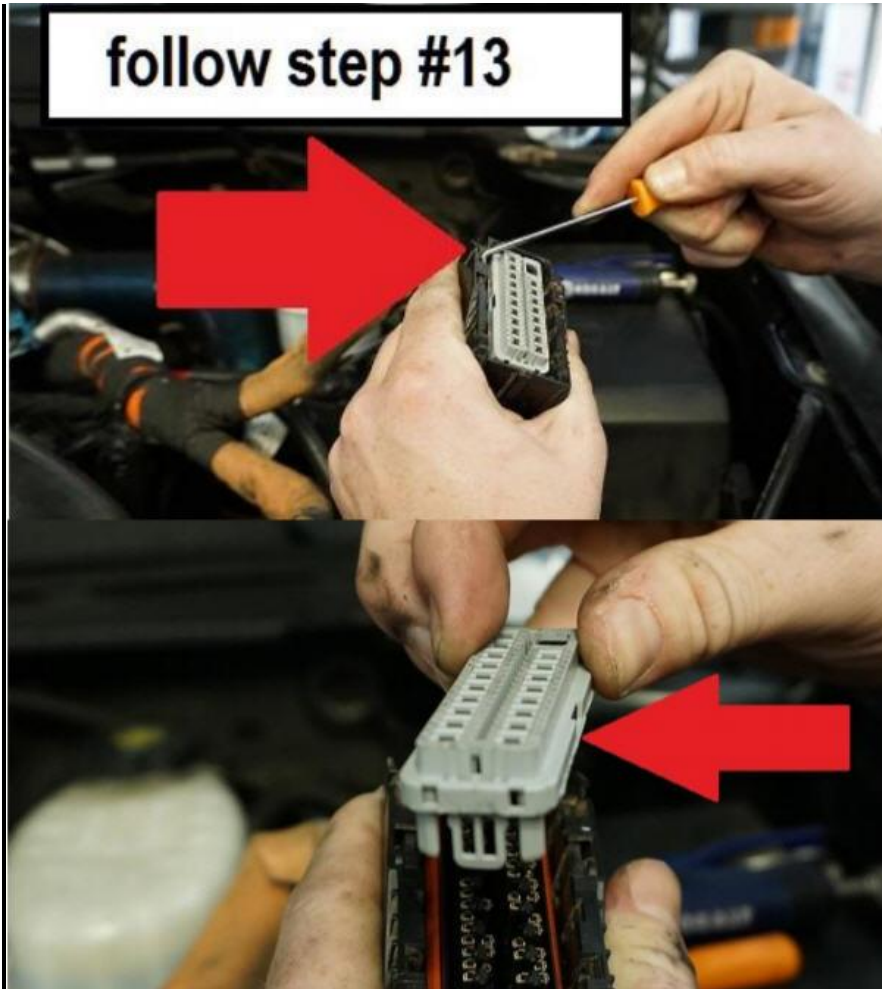

*LML DSP Switch Installation*

15. With the gray cap removed locate pin holes #11 & #35. 2011 model trucks will have a yellow wire running to pin #11. 2012 – 2016 model trucks have plastic filler pins in holes #11 and #35.

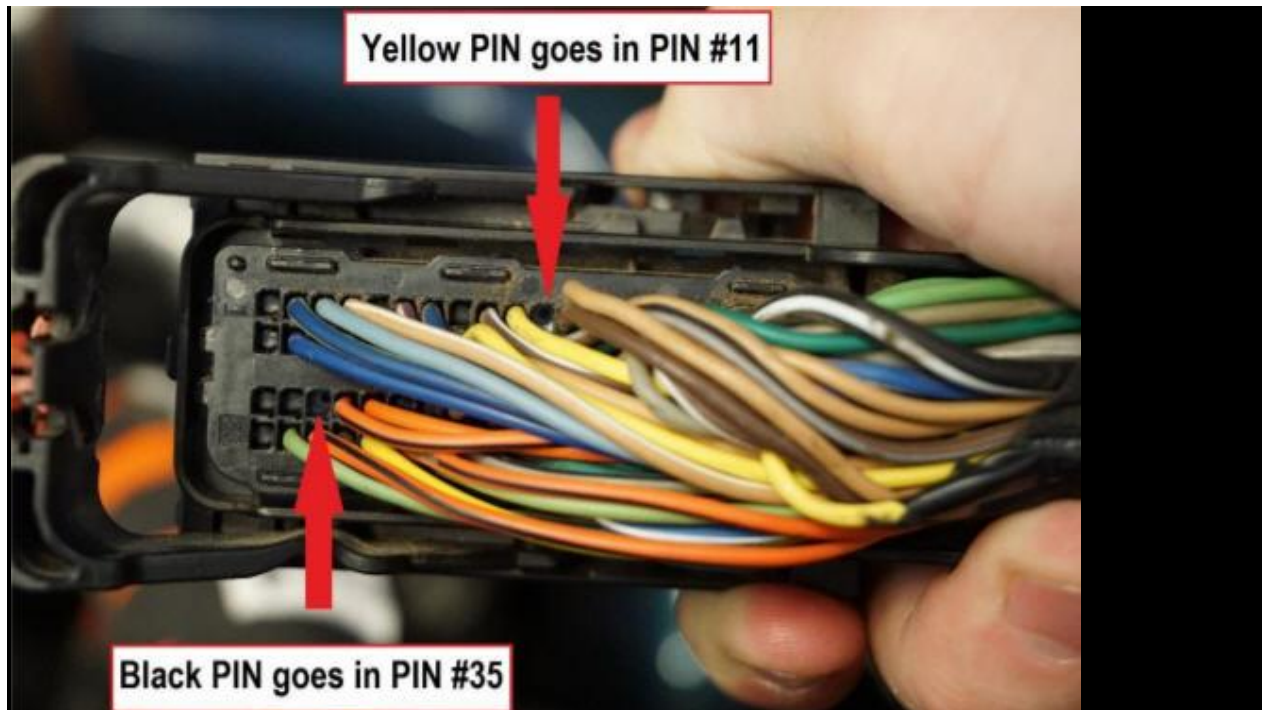

*LML DSP Switch Installation*

16. 2011 only – to remove the yellow pin from #11 use a small tool of some sort (paper clip) to put pressure on the release on the bottom side of the plug. (We used an angled pick to release pin #11)

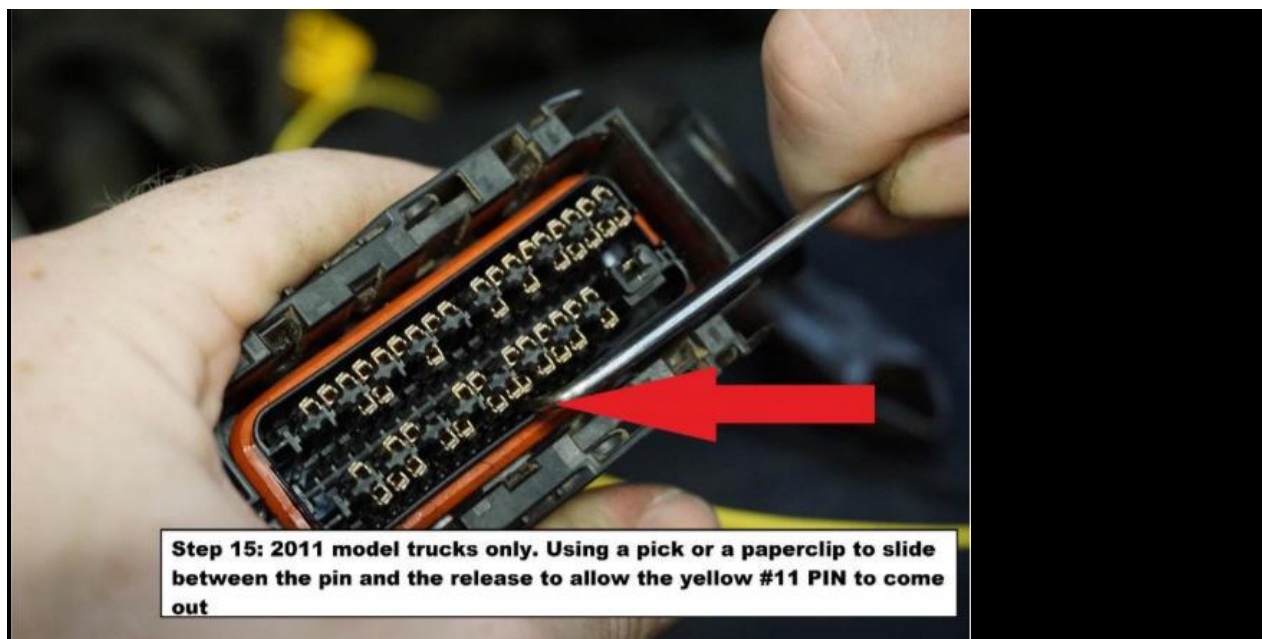

*LML DSP Installation*

17. To remove the black plastic filler pins from pin location #11 and #35 use a 1/16 drill bit. Placing the flat end of the drill bit on the bottom side on the hole. Apply pressure to the drill bit and push the plastic filler pin out the top. (Be very careful pushing the plastic pins out they will need more pressure applied to them then your fingers can apply)



LML DSP Switch Installation

18. Now that both 11 & 35 are open slots on the ECM plug, route your yellow and black wire to the plug (take into consideration that the plug is higher than where it normally would be when installing the wires into the plug, you may want to route your wire under or around to avoid any issues with plugging it in).

19. Take the Yellow wire and put it in the #11 PIN hole. (To make sure that it is in all the way you can verify by looking at the back side to make sure it's flush with all the other pins. The PIN shouldn't be able to be pulled out the top side.) Repeat this for the Black wire that goes into PIN #35.

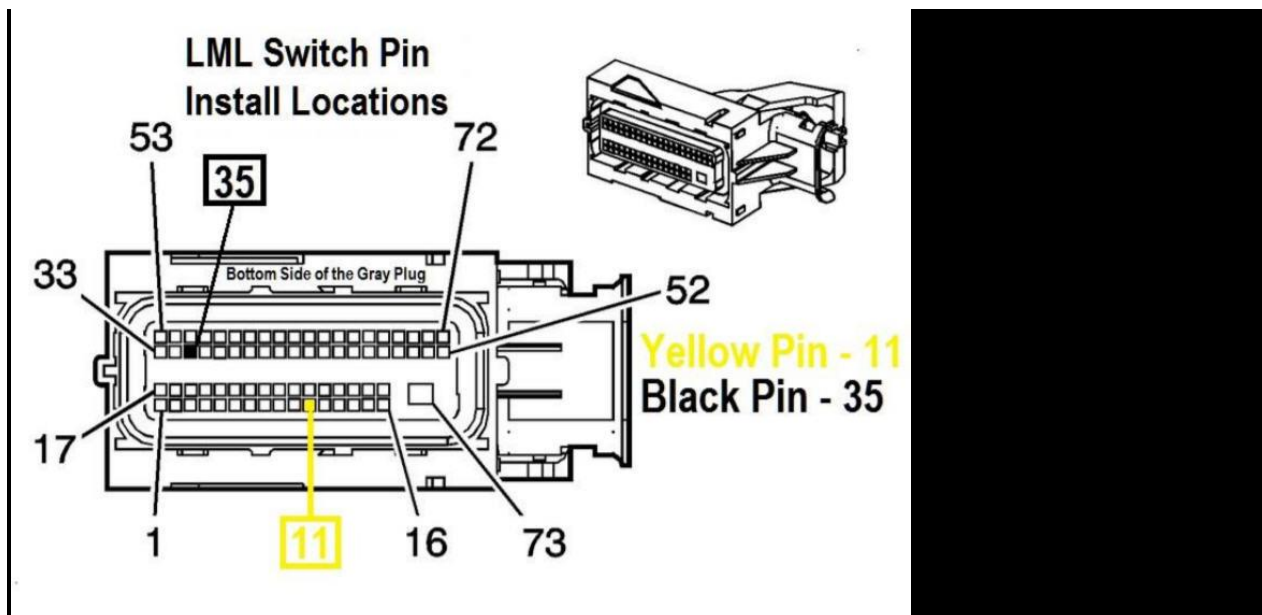

*LML DSP Switch Installation*

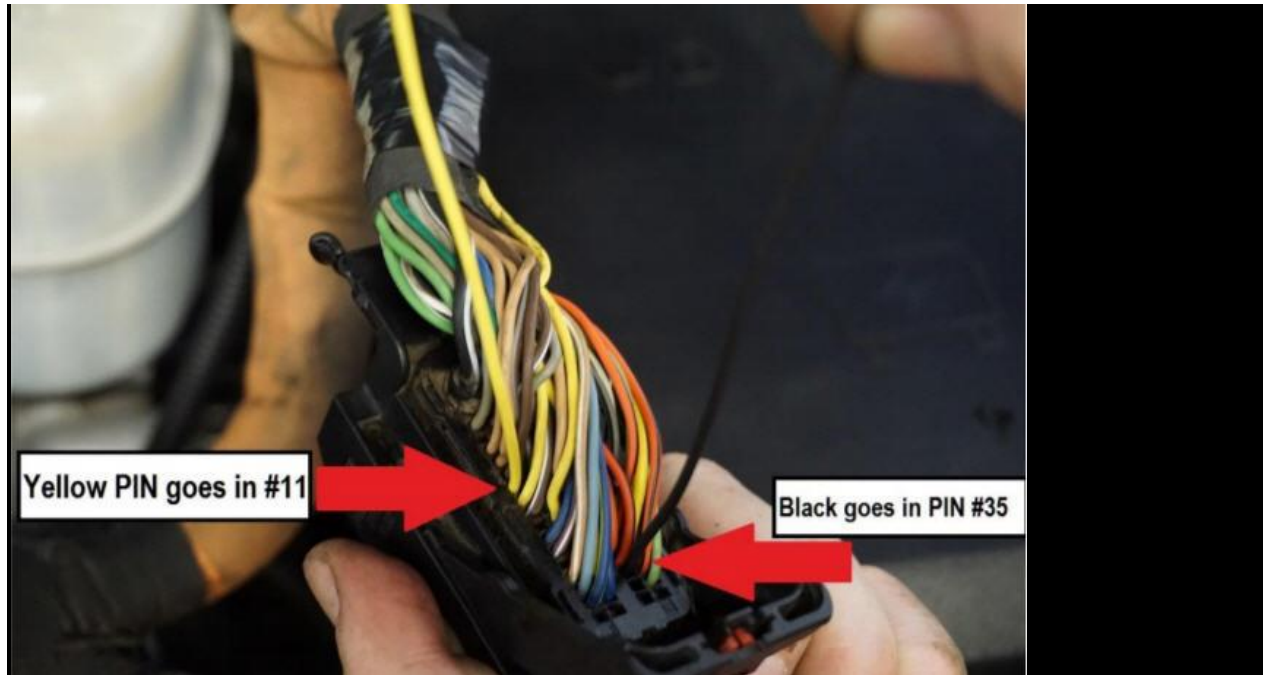

*LML DSP Switch Installation*

20. With both the Yellow and Black wires installed, put the gray bottom cover back on the plug. (make sure that it doesn't push the wires back out the top side when putting the gray cover back on)

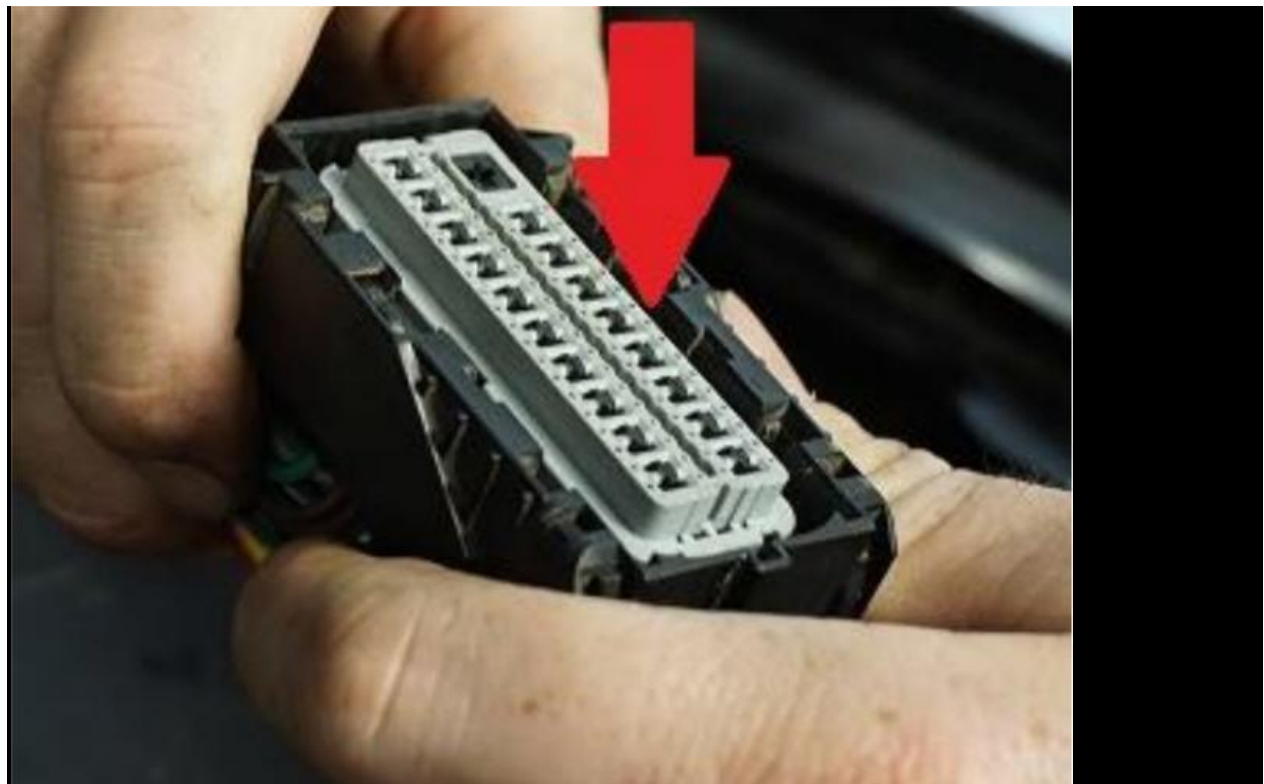

*LML DSP Switch Installation*

21. Using a zip tie fasten the wires to the plug where you use the snips to cut the original factory zip tie.

22. Place the black wire cover cap back on to the plug.



*LML DSP Switch Installation*

23. Carefully plug the gray J3 ECM plug back into the ECM.

24. The LML Switch is now installed. You may mount the switch anywhere in the cab that you please.