

# PIONEER®

9000 - 24000 BTU  
115V, 230V/1Ph/60Hz



## PIONEER® DIAMANTE *ULTRA*

SINGLE-ZONE DUCTLESS  
HEATING, COOLING, AND  
DEHUMIDIFICATION SYSTEM

HIGH WALL-MOUNTED SERIES  
Up to 23 SEER / 10 HSPF / 13 EER  
Variable Speed, DC Inverter, Heat Pump

**Ultra-Low Ambient Heating** / **Ultra-High Ambient Cooling**

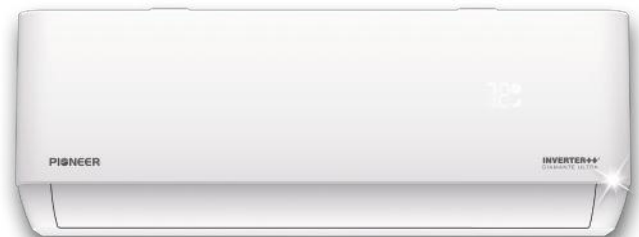

**Life is just so busy these days.** And how can we possibly keep up with all that's going on? Well, it starts with cool, clean air. But that shouldn't be another thing you need to focus on. It should just be there - a reliable constant, like electricity or water. After all, good airflow should go unnoticed, and take place behind the scenes, so you can move on to every thing else that's going on. It is when we are comfortable and relaxed that we focus best.

But how do we acquire this cool, clean air, reliably and silently? Where/how do we start?

PIONEER® DIAMANTE ULTRA SINGLE-ZONE DUCTLESS WALL-MOUNTED MINI SPLIT  
**Variable Speed / DC Inverter / AC Heat Pump**



As quiet as  
**27** dB

40	Quiet Library
30	Whisper
27	Diamante Ultra
20	Leaves Rustling

### The Search for Perfect Air is Over

Pioneer's newest **Diamante Ultra** line is the first model of its kind to deliver on all of the features we've dreamed that air conditioning could have. It is ultra easy to install, ultra silent, and also ultra efficient. It is so efficient, in fact, that switching to this system pays for itself before you know it. And the best part of all, is that being a reversible heat pump means all year-round heating and cooling.

**Diamante Ultra** is perfect for homes, offices, and ADUs or even moving structures. Anywhere that needs a heating/cooling solution which draws very little energy, is silent like an empty library, and requires extremely minor modification to the dwelling, Pioneer's Diamante Ultra system is the perfect candidate for. It is truly the Swiss army knife of heating, cooling, and dehumidification.





**PIONEER**<sup>®</sup>

*Join the Ductless Movement Today.*

You're a very particular person, looking for a very particular solution. You want a low footprint, ninja-quiet system that does not vibrate or shake outside. It should be easy to install and maintain. It should do nothing but sit there and perform its duty, which is to pump heat from outside, into the room....or dump the heat it removed from the room, to outside. **That's it.**

 **Continuous cooling** all the way up to **140°F** outside, and full capacity at 122°F.



**Welcome to that solution.** Pioneer outside condenser units are easy to maintain, as quiet as 50 dB, and are built to last year after year, even through every rough season. They only use the latest technologies, so you're maximizing savings from the energy bill. *It's like it's not even there.*



 **Continuous heating** all the way down to **-13°F** outside, and high capacity at -4°F.

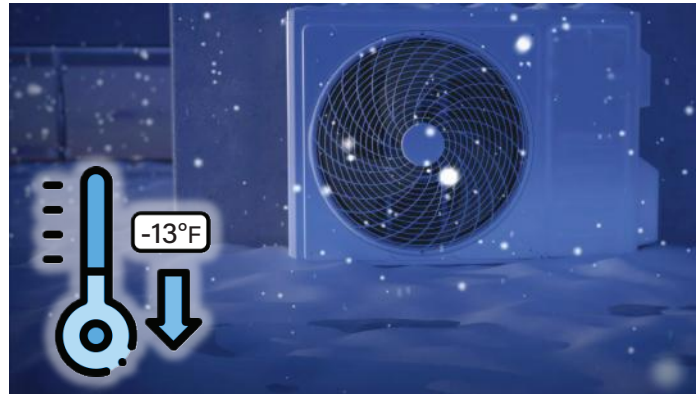

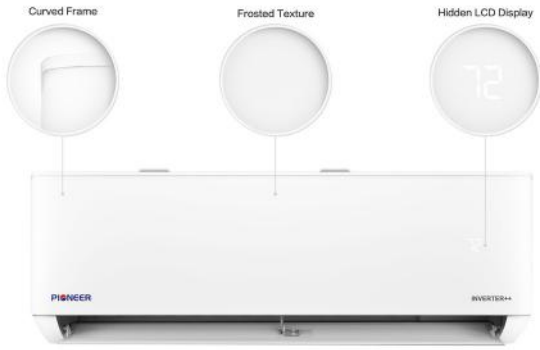

## NEW ENHANCED AESTHETIC DESIGN

*A clean look that blends with your interior decor*

How do you improve upon an air handler that's already silent? You make the **appearance** of it silent as well, with a premium encasing. A matte-frost finish ensures less fingerprints and wiping. The curved edges give the system a softer look, and the LED display has been modified to show the set temperature in a more subdued fashion.

## 133°F HIGH-TEMP. SELF-CLEANING

*Eliminate bacteria buildup with a single button press*

You can clean the filters as often as you like, but what about those germs that get caught on the coil from the constant moisture in the room? Well, the Diamante Ultra has a solution for that too. A one-click sterilization cycle uses a repeating loop of frosting/defrosting and high temperature drying to achieve an ultra high bacteria neutralization rate.

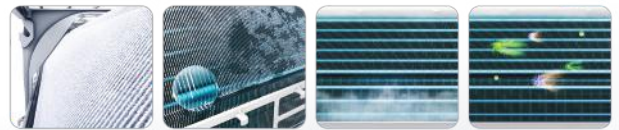

## COOLS LIKE A REFRESHING SHOWER

*Drape the room with a satisfying breeze from above*

Cool air sinks from high to low, and so it makes sense to design the system to let the conditioned air be "thrown" toward the ceiling, so that it can naturally reach as far as possible horizontally in the room, while also ensuring that the refreshing breeze is felt by all occupants of the room, no matter if they are sitting, standing, or lying down.

## HEATS LIKE A NUZZLING BLANKET

*Wrap the room in cozy warmth, from floor to ceiling*

Just as how cold air sinks, hot air rises. Pioneer's Diamante Ultra system can use this quality to its advantage by directing the louver at a sharp downward angle, so that the air throw sweeps across the floor as far out as possible, and swells upward to saturate the room with a comforting blanket of warmth, to all four corners of the room.









# EVERYTHING YOU NEED FOR A PROFESSIONAL INSTALLATION

Each set includes a complete system and kit that is ready to be up and running in a single afternoon. Eliminate those time consuming steps by taking advantage of an R410a-precharged outside unit, a full 16 ft. long set of insulated and pre-flared copper tubing plus 16' control cable, and an indoor unit that includes a wall-hole drilling template and mounting plate. The handheld remote allows full control of the system. Just provide the electrical hookup and tools, we'll bring everything else.

## SYSTEM HIGHLIGHTS:

- 
**3D Air Swing** The indoor air handler has motorized louvers to direct the air both up-down and left-right, to ensure full and even airflow distribution to the entire space.
- 
**Full Install Kit** Everything needed for a clean installation is included - A 16' set of pre-flared copper insulated piping, 16' signal cable, 10' drain tube, plus a wall passage sleeve liner kit.
- 
**Full Precharge** The outside section contains a full factory charge of R410a to support lineset lengths up to 25' long, simply first remove the air from the lines prior to releasing the coolant.
- 
**Easy Cleaning** The updated product design utilizes 23% less screws and hardware, making system disassembly much faster. Cleaning as well as general maintenance is now 12% quicker.
- 
**Money Saving** Your new AC Heat Pump system saves you hard-earned dollars day-in and day-out, due to the ultra-high efficiency rating and Energy-Star certification (rebates-eligible).

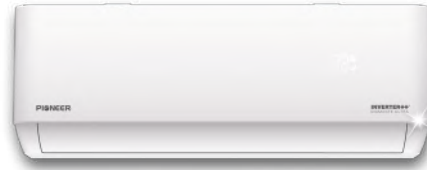

Wall-Mounted Indoor Unit



Outdoor Condensing Unit



16' Installation Kit (Pipe+Cable)



Handheld Remote Controller

23 SEER splits use **39% less energy** than your old 14 SEER central system

**Switch Today and Save up to \$1,662\*!**

\*Savings in USD, for 3x12K/36,000 BTUs, calculated over 5 years before any rebates/incentives are factored in.



SEER Rating	Operating Cost (USD)
14 SEER	\$800
23 SEER	\$200

## INTELLIGENT AND PROGRAMMABLE, FROM THE MOMENT YOU TURN IT ON



Unlock the full potential of your new Pioneer system by activating the USB module included with your purchase. In 2 minutes you'll be up and running, and ready to set custom schedules or fully control your system from across the world. Control one or many units from the same app, easily and reliably.

Simply download the Pioneer Airlink smartphone app, complete registration of your system, and you'll never need to use the handheld remote again.

Now you can pre-condition your home before your arrival, turn off the system remotely or check that your pets are relaxing in a comfortable temperature.

You can also integrate your new mini split into a Smart Home environment, thanks to the numerous integrations available from within the Airlink app.

- Turn the System On or Off
- Change Set Temperature
- Change Operating Mode
- Set Custom Schedules
- Control 3D Air Louvers
- Turn Vacation Mode On or Off
- Configure the Fan Speed
- Turn Sleep or Eco Mode On or Off
- Initiate a Self-Cleaning Cycle
- Activate any Sanitary Ionizers



COMPATIBLE WITH YOUR FAVORITE ASSISTANTS



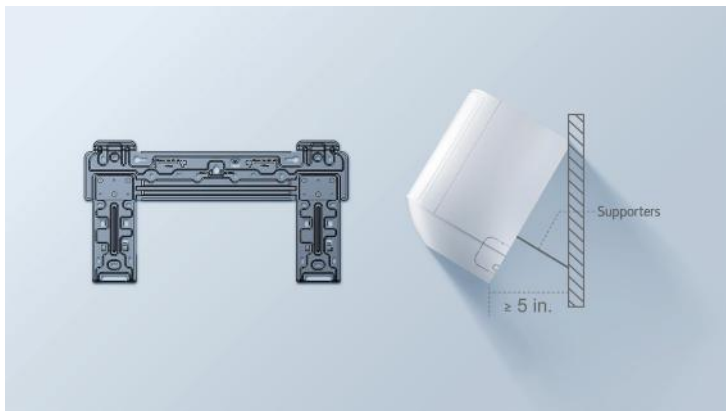

## A MUCH SMARTER MOUNTING PLATE

*Enjoy a more comfortable working environment.*

The mounting bracket for the air handler unit includes fold-out metal support rods that act as a wedge, to keep the unit at an angle and facilitate a much easier way of making the connections between the pigtail stems and the lineset. This is also beneficial to have during the leak-checking process, or for maintenance/diagnostics later on.

## EASY DETACHABLE BOTTOM COVER

*Improved accessibility to the crucial components.*

The bottom side of the air handler unit includes a bottom cover that is easily removable, exposing some handy elements that cut out a lot of the guesswork. Use the viewing window for making both the piping and electrical connections, and gain access to a single-press button to unlatch the unit from the plate for an easy removal.

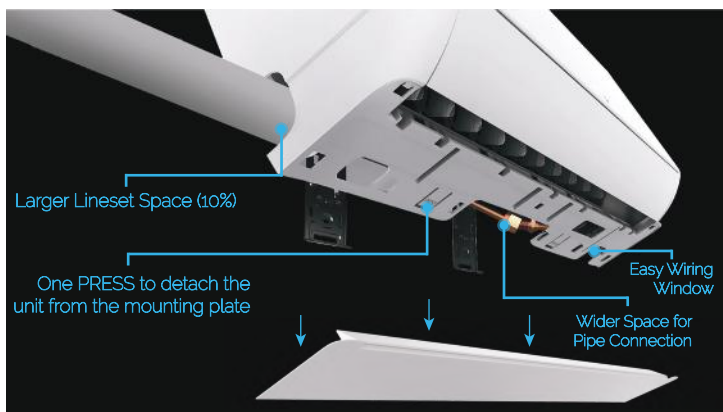

## WIDE WINDOW FOR VIEWING PIPING

*Take all of the pain out of doing a leak-check.*

In the past, performing installation or doing any maintenance behind the unit was a hassle. Now, you can work in comfort thanks to the 6.5" long wide viewing window underneath the bottom of the unit. Check for leaks and make all of the piping connections easily, without having to work at a tightly cramped and highly restrictive angle.

## EASY SLIDE-OUT INDOOR UNIT PCB

*Cut maintenance and servicing time by over half.*

The Diamante Ultra was designed with ease of service in mind. Removing the indoor board is as easy as lifting up the front panel, removing the electronic cover, and sliding out the PCB in one move. It's so easy, you could do it with one hand. Now, you can install any accessories like UV lights, drain pumps, or WiFi modules in a breeze.

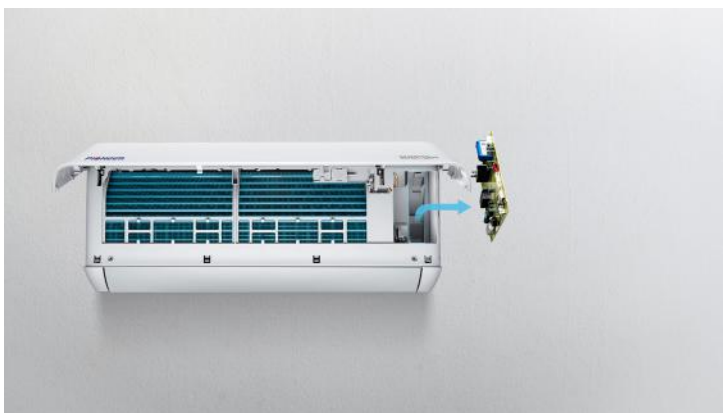



Model Number	Voltage (V)	Indoor Unit Dimensions (WxDxH, in.)	Outdoor Unit Dimensions (WxDxH, in.)	System Size and Recommended Room Matching		Efficiency Rating		
				BTU (Unit Size)	Sq.Ft (Room Size)	SEER	EER	HSPF
WYT009ALFI22RL	110/120	32-1/4 x 12 x 7-5/8	28-5/8 x 12 x 21-5/8	9000	50-350	22	12.5	10
WYT012ALFI22RL	110/120	36-1/4 x 12 x 7-5/8	28-5/8 x 12 x 21-5/8	12000	200-450	22	12.5	10
WYT009GLFI22RL	208/230	32-1/4 x 12 x 7-5/8	28-5/8 x 12 x 21-5/8	9000	50-350	23	13	10
WYT012GLFI22RL	208/230	36-1/4 x 12 x 7-5/8	28-5/8 x 12 x 21-5/8	12000	200-450	23	13	10
WYT018GLFI22RL	208/230	43-1/4 x 13-1/8 x 8-3/4	33-1/4 x 15 x 27-1/2	18000	300-650	21.5	13	10
WYT024GLFI22RL	208/230	43-1/4 x 13-1/8 x 8-3/4	36 x 15-5/8 x 31-5/8	23000	450-950	20	12.5	10

*\*All systems are rated to operate down to **-13°F** (in heating) and **140°F** (in cooling) outside temperatures.*



Proper sizing and installation of equipment is critical to achieve optimal performance. This product meets ENERGY STAR requirements when appropriate coil components are used. Ask your contractor/installer for more details.



The AHRI Certified® mark indicates Parker Davis's participation in the AHRI Certification program. For verification of individual certified products, please go to [www.ahridirectory.org](http://www.ahridirectory.org).

To receive a *free quote* today, give us a toll-free call at **800-675-7410**.

You can also view pricing, technical specifications, and frequently asked questions by visiting us online at [www.pdhvac.com](http://www.pdhvac.com), or place a new order at [www.pioneerminisplit.com](http://www.pioneerminisplit.com).

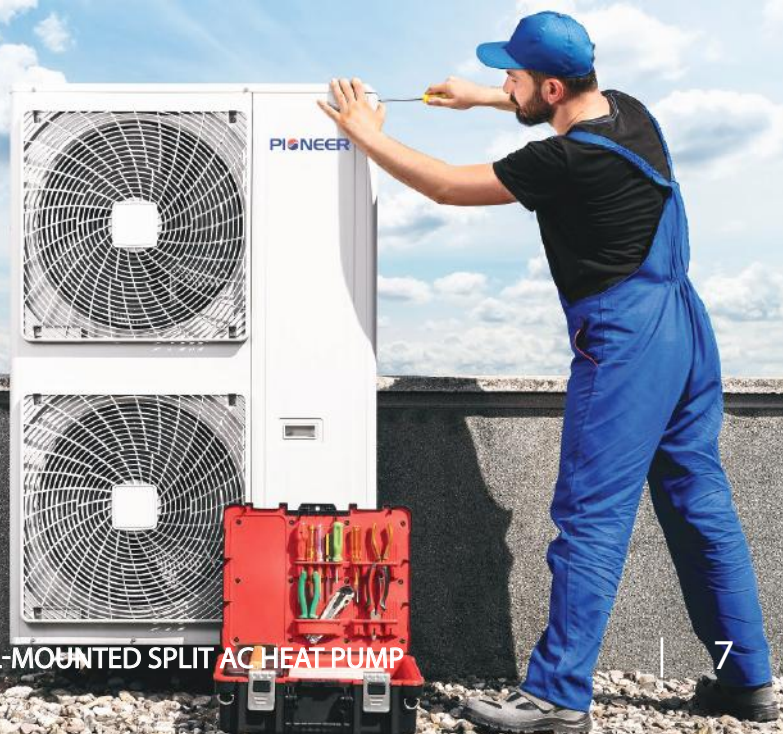





**Parker Davis HVAC International** has been one of the largest suppliers of ductless mini-split and multi-split systems in the country for over 25 years.

We have been proudly supplying our products to almost every country and region of the world through our chain of established distributorships, long before such ductless split systems have become widely available in North America.

We are one of world's most renowned manufacturers and suppliers of environmental control apparatus. Most of our products sold here are top quality **PIONEER®** brand equipment. We have several online sales channels that have been established in order to offer direct factory-level pricing to the general public in North America.

Our promise is to provide you with top quality HVAC equipment at affordable prices and with instant availability.

## WARNINGS:

In order to receive warranty coverage, the system must be installed carefully, correctly, and the product registration form filled out and submitted, either online or via e-mail.

Always follow the instruction manuals that were included with your system when installing or operating the device.

Pay close attention when applying power to the system. Always ensure you are supplying the necessary voltage.

## ADDITIONAL INFORMATION:

*Warranty coverage applies to internal parts and the compressor, labor/shipping costs are not included. Systems that are not registered within 90 days of delivery fall under "Basic Warranty" coverage of 1 year. Properly registered systems qualify for 5 years of warranty coverage on both parts and the compressor. In order to qualify for the full 10 Year Warranty, the system must have been installed by a licensed and Pioneer-certified contractor. All warranties are tied to the original purchaser and are non-transferrable.*

*App Store and Homekit are registered trademarks of Apple Inc.*

*Google Play and Google Assistant Logos are trademarks of Google LLC.*

*SMARTTHINGS is a trademark of Samsung Electronics Co., Ltd.*

*Alexa is a trademark of Amazon Technologies Inc.*

**PIONEER** is a registered trademark of Parker Davis HVAC Intl., Inc.

Before purchasing this appliance, read important information about its estimated annual energy consumption, yearly operating cost, or energy efficiency rating that is available from your retailer.

Do not attempt to use different brand parts or components with your Pioneer system. Spare parts and components are available for purchase online or by calling Pioneer directly.

Save all documents and manuals for your future reference.

For more information, see our FAQ and document library online at [www.pdhvac.com](http://www.pdhvac.com), or visit the retailer where you purchased your system in order to request more information.

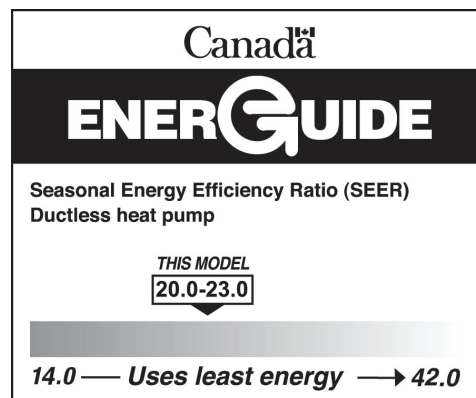

We strive to always provide an exceptional customer experience, which may result in a change in specification without notice.  
© 2022 **PARKER DAVIS HVAC INTERNATIONAL, INC.** Doral, Florida 33172 - USA - [www.pdhvac.com](http://www.pdhvac.com) or [www.pioneerminisplit.com](http://www.pioneerminisplit.com)

REV050722