



USER'S MANUAL

30" Slide-In Electric Range

WiFi Connectivity with Smart Device App

5-Element Glass Ceramic Cooktop

6.3 Cubic Feet Total Oven Capacity

Glass Touch Controls

"Built In" Appearance

Note:

Before using this product, please read this manual carefully and keep it for future reference. Contact Midea Customer Service at 1-866-646-4332 or visit midea.com/us/support for assistance.



(Pictures are for reference only and may not accurately represent all models covered by this manual.)

MODEL NUMBERS
MES30S2AST
MES30S4AST
www.midea.com

Dear user

Thank you for letting Midea help you "make yourself at home. "

This manual is part of our commitment to your total satisfaction.

Please read this manual carefully before use and keep it in a convenient place for future reference.

To help us serve you better, please consider registering your product using our convenient Midea app MSmartlife, by visiting <http://www.midea.com>, or by texting a picture of your proof of purchase to **1-844-224-1614**.

By using the text option you will earn an additional 3 month warranty extension immediately following the completion of the product's original warranty.

SAFETY WARNINGS	5
PREPARING FOR FIRST USE	12
Range Overview	12
Review of Controls	13
WiFi Connection	14
Setting the Clock	14
Before First Use	15
COOKTOP OPERATION	16
Warnings	16
Types of Cooking Elements	16
Pan Size/Element Size Selection	17
Cooktop Indicators	17
Controlling the Cooking Elements	18
Controlling the Warming Elements.....	19
OVEN OPERATION	20
Warnings	20
Oven Racks.....	21
Removing/Inserting Racks	22
Rack Positions: Preheating	23
Bake	24
Keep Warm (some models)	25
Broil	26
Proof	26
Convection Bake	28

Convection Roast	28
Pizza	29
Delay	30
Cook Time	31
Probe (some models)	33
Sabbath Mode	34
Steam Clean	34
Self Clean	35
WiFi (Remote Operation)	36
Timer.....	37
Oven Light	37
CONTROL SETTINGS	38
CLEANING AND MAINTENANCE	40
Tip-Over Hazard	40
Glass Cooktop.....	40
Control Panel.....	41
Oven Interior	42
Oven Lights	43
Drawer.....	43
Door	44
TROUBLE SHOOTING.....	46
Cooktop	46
Oven	47
Warrant	49

IMPORTANT SAFETY INSTRUCTIONS
READ ALL INSTRUCTIONS BEFORE USING THE APPLIANCE

SAFETY DEFINITIONS

Warnings and safety instructions in this manual do not cover all possible conditions and situations that may occur. It is your responsibility to use common sense, caution, and care when installing, maintaining, and operating your oven. Known hazards and their severity are identified in this manual with the following symbols:

⚠️ WARNING

This symbol indicates the presence of a hazard which may result in death or serious injury if not avoided.

⚠️ CAUTION

This symbol indicates the presence of a hazard which may result in minor or moderate personal injury if not avoided.

NOTICE

This symbol indicates the presence of a hazard which may result in minor property damage if not avoided.

NOTE

This alerts the user to information that will help avoid confusion or common cooking mistakes and obtain the best possible user experience.

⚠️ WARNING

Read all safety instructions before using this product. Failure to follow these instructions may result in fire, electrical shock, serious injury, or death. It is the owner's responsibility to ensure that anyone using the appliance knows how to operate it safely.

IMPORTANT SAFETY INSTRUCTIONS

READ ALL INSTRUCTIONS BEFORE USING THE APPLIANCE

⚠WARNING

TIP OVER HAZARD

A child or adult can tip the range and be killed. Verify the anti-tip device has been properly installed and engaged per installation instructions. Ensure the anti-tip device is re-engaged when the range is moved.



Anti-Tip Bracket

Do not operate the range without the anti-tip device in place and engaged. Failure to do so can result in death or serious burns to children or adults. Do not remove the leveling legs. Doing so will prevent the range from being secured by the anti-tip device.

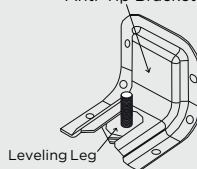

Leveling Leg

To confirm the anti-tip bracket is properly installed, look underneath the range to confirm rear leveling leg is engaged in bracket. If visual inspection is not possible:

- Slide range forward
- Confirm anti-tip bracket is securely attached to floor or wall in correct position according to installation instructions.
- Fully slide the range back against the wall so that leveling leg engages with anti-tip bracket.

If range is removed from service, secure door closed or remove door to minimize tip over risk. (See "Door" section under "Cleaning and Maintenance" in this manual for instructions on how to remove door.)

⚠WARNING

INSTALLATION AND MAINTENANCE

- This appliance is intended for normal residential use. It is not approved for commercial use, outdoor installation, or any other application not specifically allowed by this manual.
- Be sure your appliance is properly installed and grounded by a qualified service provider.
- **DO NOT** operate this appliance if it has been damaged or is not working properly. Contact a qualified service provider for repairs.
- **DO NOT** repair or replace any part of the appliance unless specifically recommended in the manual. All other servicing should be referred to a qualified service provider.

IMPORTANT SAFETY INSTRUCTIONS

READ ALL INSTRUCTIONS BEFORE USING THE APPLIANCE

- **DO NOT** allow cooking grease or other flammable materials accumulate in or on the range. Grease in the oven or on the cooktop may ignite.
- Clean kitchen ventilating hoods frequently. Grease should not be allowed to accumulate on hood or filter.
Clean cook-top with caution – To avoid steam burns, do not use wet sponge or cloth while cooking area is hot. Some cleaners can produce noxious fumes if applied to a hot surface.
- **DO NOT** use oven cleaners. No commercial oven cleaner or oven liner protective coating of any kind should be used with any part of this appliance.
- Do not clean door gasket – The door gasket is essential for a good seal. Care should be taken not to rub, damage, or move the gasket.
- Clean only parts and areas listed in the "Cleaning and Maintenance" section of this manual.

⚠WARNING

GENERAL USAGE

- This appliance is configurable to allow remote operation at any time. Do not store any flammable materials or temperature sensitive items inside oven, in storage drawer, or on top or near cooktop heating elements of the appliance.
- Never use your appliance for warming or heating the room.
- Children should not be left alone or unattended in the area where appliance is in use.
- Do not allow anyone to climb, stand, lean, sit, or hang on any part of an appliance, especially a door, drawer or operation panel.
- **CAUTION** - Do not store items of interest to children in cabinets above a range or on the backguard of a range – children climbing on the range to reach items could be seriously injured.
- Loose-fitting or hanging garments should never be worn while using the appliance.
- This appliance has not been evaluated for use with any 3rd party after-market systems. Do not attempt to use this appliance with a working or any other after-market device.

IMPORTANT SAFETY INSTRUCTIONS

READ ALL INSTRUCTIONS BEFORE USING THE APPLIANCE

⚠WARNING

COOKTOP HAZARDS

- DO NOT USE WATER ON GREASE FIRES. Smother fire or flame with a close-fitting lid or metal tray. Never pick up a flaming pan. Dry chemical or foam-type extinguisher may be used if it is CLASS ABC or CLASS K and you already know how to use it.
- It is strongly recommended that a CLASS ABC or CLASS K fire extinguisher be kept near the range in an easily accessible location, and that household members are familiarized in advance with its operating instructions.
- Never leave cooktop heating elements unattended. Boil-over causes smoking and greasy spillovers that may ignite.
- Only certain types of glass, glass/ceramic, ceramic, earthenware, or other glazed utensils are suitable for range-top service without breaking due to the sudden change in temperature.
- To reduce the risk of burns, ignition of flammable materials, and spillage due to unintentional contact with the utensil, the handle of a utensil should be positioned so that it is turned inward, and does not extend over the front of the counter top or over adjacent cooktop heating elements.
- Do not cook on a broken cook-top – If cook-top should break, cleaning solutions and spillovers may penetrate the broken cook-top and create a risk of electric shock. Contact a qualified service provider immediately for repairs.
- DO NOT TOUCH COOKTOP HEATING ELEMENTS OR AREAS NEAR ELEMENTS – Cooktop heating elements may be hot even though they are dark in color. Areas near cooktop heating elements may become hot enough to cause burns. During and after use, do not touch, or let clothing or other flammable materials contact cooktop heating elements or areas near elements until they have had sufficient time to cool. Among these areas are the cook-top and surfaces facing the cook-top.
- Use proper pan size. This appliance is equipped with cooktop heating elements of different size. Select utensils having flat bottoms large enough to cover the entire cooktop heating element heating element. The use of undersized utensils will expose a portion of the heating element to direct contact and may result in ignition of clothing. Proper relationship of utensil to burner will also improve efficiency.

SAFETY
INSTRUCTIONS

PREPARING
FOR FIRST USE

COOKTOP
OPERATION

OVEN
OPERATION

CONTROL
SETTINGS

CLEANING
AND
MAINTENANCE

TROUBLESHOOTING

IMPORTANT SAFETY INSTRUCTIONS

READ ALL INSTRUCTIONS BEFORE USING THE APPLIANCE

- In the event that personal clothing or hair catches fire, drop and roll immediately to extinguish flames.
- Always turn hood ON when cooking at high heat or when flambéing food (i.e. Crepes Suzette, Cherries Jubilee, Peppercorn Beef Flambé).
- Hot oil is capable of causing severe burns. Never move cooking utensils containing hot grease. Wait until it has cooled before disposing of grease.
- Use high heat settings only when necessary. To avoid splattering, heat oil slowly on medium-low settings.
- To prevent cooktop glass breakage, do not slide cookware across the cooking surface or otherwise scratch cooktop glass.
- In the event of house power failure, turn off any cooktop elements that were in use. This will prevent the cooktop from unexpectedly turning back on when power is restored.

⚠WARNING

OVEN HAZARDS

- Never place anything (aluminum foil, spill mat, baking stone, cookware, etc.) on the bottom of the oven cavity. These items can trap heat or melt, resulting in damage to the appliance and risk of electric shock, smoke, or fire.
- Use care when opening the door. Let hot air or steam escape before removing or replacing food.
- Use only dry pot holders. Moist or damp pot holders on hot surfaces may result in burns from steam. Do not let pot holder touch hot grates or flames. Do not use a towel or other bulky cloth.
- Do not heat unopened food containers - Build-up of pressure may cause container to burst and result in injury.
- Do not obstruct oven vents.
- Always place oven racks in the desired location while oven is cool. If rack must be moved while oven is hot, do not let pot holder contact hot heating element in oven.
- **DO NOT TOUCH OVEN HEATING ELEMENTS OR INTERIOR SURFACES OF OVEN** - Heating elements may be hot even though they are dark in color. Interior surfaces of an oven become hot enough to cause burns.

IMPORTANT SAFETY INSTRUCTIONS

READ ALL INSTRUCTIONS BEFORE USING THE APPLIANCE

During and after use, do not touch, or let clothing or other flammable materials contact heating elements or interior surfaces of oven until they have had sufficient time to cool. Other surfaces of the appliance may become hot enough to cause burns – among these surfaces are oven vent openings and surfaces near these openings, oven doors, and windows of oven doors.

- Do not use a broiler pan without its insert. Do not cover the broiler insert with aluminum foil, as exposed fat and grease could ignite.
- If materials inside the oven should ignite, keep door closed and turn off power at the fuse or breaker box. Wait for the oven to cool before removing contents, cleaning the oven, and restoring power.
- Do not obstruct oven vents or any other slots or openings on the unit.

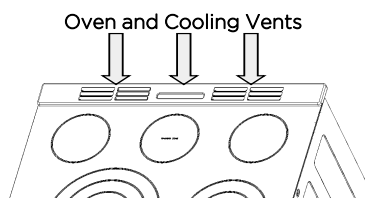

▲ WARNING

SELF CLEAN HAZARDS

- Before self-cleaning the oven, ensure oven is empty. Remove broiler pan, racks, cookware, and anything else.
- To avoid ignition inside the oven, clean excess grease or food out of the oven before starting self clean.
- The door will lock several minutes after the start of a self-clean function. If the door is opened prior to being locked, the self-clean function will be automatically cancelled. If door does not lock within 15 minutes, cancel self-clean and contact a qualified service provider for repairs.
- In the event of ignition inside the oven during self-clean, turn off the oven and wait for the fire to extinguish. **DO NOT FORCE THE DOOR OPEN.** Wait for the oven to cool before removing contents and cleaning the oven.
- If the self-cleaning mode malfunctions, keep door closed, turn off the appliance, disconnect the circuit at the circuit breaker box, and contact a qualified service provider for repairs.
- Some birds are extremely sensitive to the fumes produced during a self-clean cycle. Move birds to another well-ventilated room.

IMPORTANT SAFETY INSTRUCTIONS

READ ALL INSTRUCTIONS BEFORE USING THE APPLIANCE

⚠ CAUTION

FCC NOTICE

- According to Federal Communication Commission requirements, this equipment has been tested and found to comply with the limits for a Class B digital device, pursuant to part 15 of the FCC Rules. These limits are designed to provide reasonable protection against harmful interference in a residential installation. This equipment generates, uses and can radiate radio frequency energy and, if not installed and used in accordance with the instructions, may cause harmful interference to radiocommunications. However, there is no guarantee that interference will not occur in a particular installation. If this equipment does cause harmful interference to radio or television reception, which can be determined by turning the equipment off and on, the user is encouraged to try to correct the interference by one or more of the following measures:
 - Reorient or relocate the receiving antenna.
 - Increase the separation between the equipment and receiver.
 - Connect the equipment into an outlet on a circuit different from that to which the receiver is connected.
 - Consult the dealer or an experienced radio/TV technician for help.
- This device complies with part 15 of the FCC Rules. Operation is subject to the following two conditions: (1) This device may not cause harmful interference, and (2) this device must accept any interference received, including interference that may cause undesired operation.

SAFETY
INSTRUCTIONS

PREPARING
FOR FIRST USE

COOKTOP
OPERATION

OVEN
OPERATION

CONTROL
SETTINGS

CLEANING AND
MAINTENANCE

TROUBLESHOOTING

Range Overview:

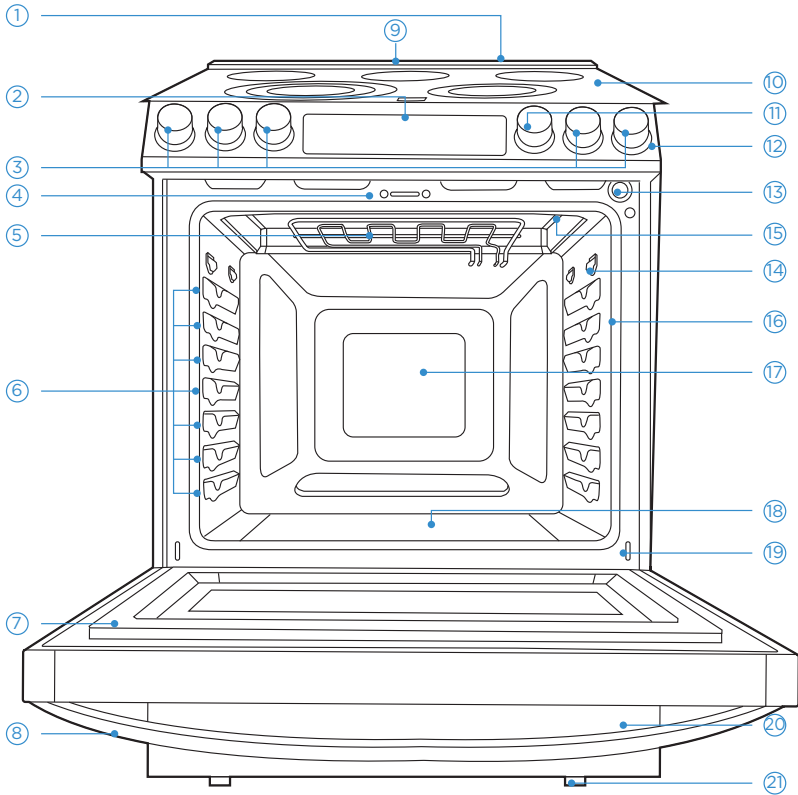

- | | | |
|-------------------------|--|--------------------------------------|
| 1 Cooling Vents | 9 Oven Vent | 16 Door Gasket |
| 2 Oven Control | 10 Cooktop | 17 Convection Fan |
| 3 Cooktop Control Knobs | 11 Control input knob or oven light switch | 18 Oven Bottom (hidden bake element) |
| 4 Door Lock | 12 Control Panel | 19 Door Hinge (each side) |
| 5 Broil element | 13 Door Switch | 20 Storage Drawer |
| 6 Rack Positions | 14 Meat Probe Jack | 21 Leveling Legs (front and back) |
| 7 Door | 15 Oven Lights | |
| 8 Door Handle | | |

Review of Controls:

All Midea ranges are provided with intuitive touch controls to help you easily take advantage of the features available in your oven. Depending on the model and configuration, your oven may be controlled in one of two ways. 6-knob models will have a dedicated knob used to set temperatures and select options. 4-knob models have a numeric keypad for entering times and temperatures.

Control user interface (Control input Knob Models):

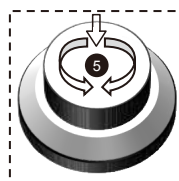

Control input Knob

Control user interface (Numeric Keypad Input Models):



(use keypad for numeric input)

- CLEAR/OFF** key - Immediately halts any oven operation. If the door is locked for self-clean, it will not unlock until the oven temperature has dropped to a safe level.
- DISPLAY** - Communicates information to the user, such as time-of-day, oven temperature, and cooking mode.
- START/ENTER** key - Initiates the selected oven operation or selects an available option. NOTE: On 6-Knob models, pressing in on the knob performs the same function as pressing the START/ENTER key.
- Oven Operations** - Select from the available operating modes to perform the desired task. Some modes, such as PROBE, COOK TIME, and DELAY, can only be used in conjunction with other modes. See mode-specific instructions in this manual for details.
- Numeric Input**- Used to enter desired oven temperature, set the clock, change settings, or input other information into the appliance.
- Auxiliary Features** - Useful features that are not specifically associated with oven operation, such as TIMER, CONTROL LOCK, and SETTINGS.

WiFi Connection:

Your oven is equipped to communicate with the Midea "MSmartLife" app, providing you with access to certain features and controls from your smartphone or tablet.* To take advantage of these features, you must first connect your oven to your WiFi network and the Midea "MSmartLife" app.

1. Have the smart devices nearby with internet access for downloading the app.
2. Have the home WiFi "Network Name" and password ready.
3. Download and install the "MSmartLife" app from Google Play or the App Store.
4. Open the app. If you have an existing account, login. Otherwise, create a new account and login.
5. Press the "Add Device" button and follow the app instructions onscreen to complete the connection.
6. Once the connection is complete, the connected  icon located on your range display will be illuminated and the app will also confirm you are connected.
7. If the connection icon does not turn on, repeat the connection instructions on the app to reconnect. If issues continue, please contact Midea customer service at **1-866-646-4332** or by visiting **Midea.com/us/support** for assistance.

To connect additional devices, repeat step 2 above for each device.

Setting the Clock:

If you have successfully connected the oven to the Midea App, the clock will automatically be set based on your location. If the app has incorrectly identified your location or you otherwise want to set a different time, the automatic setting can be disabled through the app. To set the clock manually at the appliance:

1. Press the "CLOCK" button - the time display will begin to flash.
NOTE: Some models do not have a dedicated "CLOCK" button on the control display. For these models, select the **CLCK** option under the SETTINGS menu. See "Control Settings" section later in this manual.
2. Enter the time using either the input knob or the numeric keypad, depending on your model
3. Press START/ENTER to accept the currently displayed time, or press CLOCK or CLEAR/OFF to exit to the previous time setting.

BEFORE USING YOUR NEW RANGE FOR THE FIRST TIME:

1. Ensure all packaging, literature, removable labels, and protective plastic film are removed. Check inside oven, inside drawer, and around door and trim edges carefully.
2. While cool, wipe down all surfaces, including inside oven and drawer, with a damp cloth to remove dust that may have settled during shipping and storage.
3. Familiarize yourself with the controls and features described in this manual.
4. Confirm that surface elements and oven operate as intended. Contact Midea customer service at **1-866-646-4332** or by visiting **midea.com/us/support** immediately if appliance is not working as expected.
5. Start the oven in BAKE mode at the highest available temperature setting. Allow oven to run for 1 hour to remove any dust or impurities. There will be a distinctive odor - this is normal. Ensure your kitchen is well ventilated during this conditioning period.

COOKTOP OPERATION

⚠ WARNING

FIRE HAZARD

- DO NOT USE WATER ON GREASE FIRES. Smother fire or flame with a close-fitting lid or metal tray. Never pick up a flaming pan.
- Never leave cooktop heating elements unattended. Boil-over causes smoking and greasy spillovers that may ignite. Turn off all controls when done cooking.
- Do not place items that can melt or burn on the cooktop, even when it is not being used.

⚠ CAUTION

BURN, CUT, ELECTRIC SHOCK HAZARDS

- Do not use if cooktop is broken. Cleaning solutions and spillovers may penetrate the broken cook-top and create a risk of electric shock. Contact a qualified service provider immediately for repairs.
- To prevent cooktop glass breakage, do not slide cookware across cooking surface or otherwise scratch cooktop glass. Do not use the glass cooktop as a cutting board.
- Do not store heavy items above the cooktop. They could fall and break the glass.
- To minimize burn risk and maximize cooking efficiency, cookware should completely cover the outlined area of the cooking element.
- Until the cooktop has completely cooled after use, the surface may still be hot and burns may occur after the cooking element has been turned off.
- To avoid steam burns, do not use wet sponge or cloth while cooking area is hot.

NOTICE

PREVENTING DAMAGE

- Do not allow cookware to boil dry or otherwise overheat.
- Do not cook foods packaged in aluminum foil directly on the cooktop.
- Do not otherwise use aluminum foil, or any material that could melt, directly on the cooktop.
- Never cook directly on the grates. Always use appropriate cookware.

Types of Cooking Elements:

All Midea ranges are provided with 4 cooking elements (capable of raising foods to safe cooking temperatures). Some models may also include a warming element (capable of maintaining already-cooked food at safe temperatures). Some models may include elements with multiple heating areas. The number of heating areas on each element are indicated by the rings on the glass cooktop. (Images do not represent all possible configurations.) As the cooking elements operate, they will automatically cycle on and off - even at the highest setting - to maintain power levels.

NOTE: Higher powered elements are placed towards the front for higher temperature or shorter duration cooking, such as boiling, searing, and pan frying. Lower powered elements are placed towards the rear for lower temperature or longer duration cooking, such as simmer or melting chocolate.

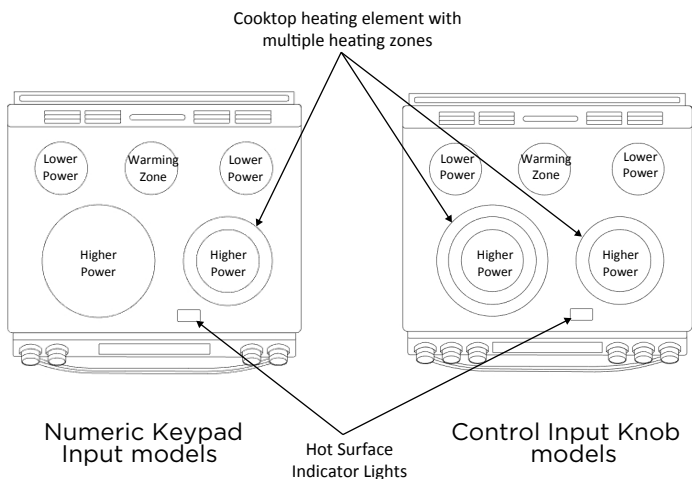

Pan Size/Element Size Selection:

To minimize burn risk and maximize cooking efficiency, cookware should completely cover the outlined area of the cooking element as indicated below:

Correct Selection:

Small Pan on Small Element



Large Pan on Large Element



Small Pan on Large Element
(with only inner ring of activated)



Incorrect Selection:

Small Pan on Large Element



Pan Off -Center on Element

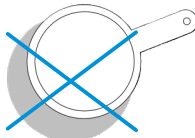

Cooktop Indicators:

All Midea ranges are provided with separate indicators alerting the user that the cooktop is in use and that the cooktop surface is hot.

Surface-On Indicator: Some models will indicate which cooktop heating element is on by use of illumination around the knob. Alternatively, other models will only indicate that a cooktop element is on using a single light on the control panel.



Surface-On Indication
by Knob Backlighting



Surface-On Indication
by Panel Indicator

Cooktop Indicators (continued):

Hot Surface Indicator: Some models will have individual indicators for each element under the cooktop glass. Alternatively, other models may only have a single light under the cooktop glass indicating that one or more elements are still hot. The Hot Surface Indicator will illuminate shortly after turning an element on, and it will remain illuminated after the element has been turned off.

NOTE: When the Hot Surface Indicator turns off, the glass surface may still feel slightly hot to the touch. Avoid touching or placing anything on the cooktop until it has completely cooled. The Hot Surface Indicator may illuminate when the cooktop heats up during self-clean or long baking cycles. This is normal.

Controlling the Cooking Elements:

To turn a cooking element on, push in on the control knob and turn in either direction. The small icon above the control knob indicates the location of the element being controlled. The various settings (from OFF to HI) are located on the knob itself. Adjust to the desired heat setting by aligning the power level on the knob to the indicator mark on the control panel. To turn an element off, simply rotate the control knob to the OFF position.

Controlling Elements with Multiple Heating Areas (some models): Even if a cooking element has multiple heating areas, each cooking element is controlled by a single knob. When controlling a cooking element with multiple heating areas, pay close attention to the markings on the knob. The region being controlled is indicated by a series of concentric rings corresponding to the areas being controlled.

1. A single dot "•" indicates only the smallest or center most section of the cooking element is being powered.
2. A dot with a ring "⊙" indicates that two center sections of the cooking element are being powered. (On an element with only two heating areas, this means both heating areas are active.)
3. A dot with two rings "◎" indicates that all three sections of the cooking element are being powered.

Icon on Control Panel indicating which element the knob controls

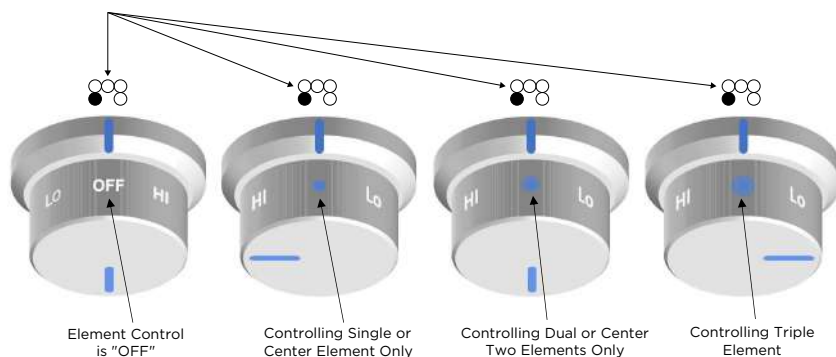

Controlling the Warming Elements (some models):

⚠ WARNING

FOODBORNE ILLNESS HAZARD

Bacteria may grow in food at temperatures below 140°F. Do not attempt to cook food using the warming element. Warming element is designed to keep cooked foods warm, not to heat cold foods.

Depending on the model and configuration, warming elements may be controlled in one of two ways. 6-knob model will have a dedicated knob for controlling the warming element. 4-knob model will control the warming element using a button on the oven control screen. Because of the limited power available in the warming element, the control is always a simple ON/OFF control and does not have adjustable settings.

Knob Control of Warming Element: To turn on the warming element, simply turn the knob 90 degrees to the ON position. This knob does not require to be pushed in before turning. To turn off, turn back to the OFF position.

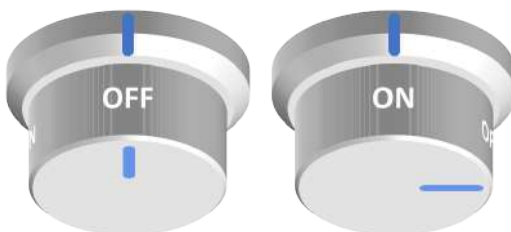

Button Control of Warming Element: The warming element control button is located on the user interface. (See Oven Controls section for depiction of user interface.) To turn on the warming element, simply press the WARMING ZONE button once. To turn off, press the WARMING ZONE button again. The words "WARMING ZONE" will be shown in the control display when the warming zone is active.



OVEN OPERATION

⚠ WARNING

FIRE HAZARD

- Never place anything (aluminum foil, spill mat, baking stone, cookware, etc.) on the bottom of the oven cavity. These items can trap heat or melt, resulting in damage to the appliance and risk of electric shock, smoke, or fire.
- If materials inside the oven should ignite, keep door closed, turn off the appliance, and disconnect the circuit at the circuit breaker box. Wait for the oven to cool before removing contents, cleaning oven, and restoring power.

⚠ CAUTION

BURN HAZARD

- Use only dry pot holders or oven mitts when using the oven.
- The oven is vented along the rear of the cooktop. When the oven is in use, this area may get very hot. Do not block or cover the oven vent.

NOTE: FOR BEST EXPERIENCE

- Proper preheating is important for good results. Unless the recipe specifically instructs differently, place food in the oven only after preheating is complete.
- For best results, place food in immediately after preheat beep is sounded.
- Steam or moisture may appear at the oven vent - this is normal.
- If your model is equipped with a convection fan, it is normal for fan to operate during preheat, even if not in convection baking mode.
- Do not leave the door open any longer than necessary. If the door is left open too long, the baking mode will be automatically cancelled.
- If in operation, the convection fan will automatically shut off any time door is opened.
- If oven is left in operation for extended periods, it will automatically shut off. Bake modes shut off after 12 hours, Broil will shut off after 1 hour.

Oven Racks:

Flat Rack: Versatile and low profile, each range is

supplied with one or more flat oven racks. Flat racks slide in and out of oven on rack guides formed into side of oven wall. Multiple racks can be used simultaneously, if desired. **REMOVE DURING SELF-CLEAN TO PREVENT DISCOLORATION.** If racks do not move smoothly, use the corner of a paper towel to apply a thin layer of vegetable oil to reduce friction. Wipe off any excess before use.

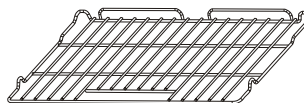

Extension Rack: Slides in and out of oven on ball

bearing slides, allowing heavier dishes to be moved smoothly and easily. **REMOVE DURING SELF-CLEAN TO PREVENT DISCOLORATION AND DAMAGE TO BALL BEARING SLIDES.** If ball bearing slides do not move smoothly, they can be lubricated with graphite powder lubricant. Do not lubricate with grease or oil.

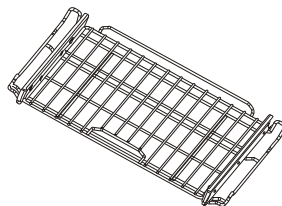

Removing/Inserting Racks:

⚠ CAUTION

BURN HAZARD

- Always place oven racks in the desired location while oven is cool. If rack must be moved while oven is hot, do not let pot holder contact hot oven surfaces.

Removing Rack: Racks are designed to stop before coming completely out of the oven to reduce the risk of dropped or spilled foods.

To remove the rack:

1. Remove all food and utensils from rack.
2. Grasp firmly from both sides.
3. Pull rack out until it contacts the stop position.
4. Lift up on the front of the rack and continue pulling outward.

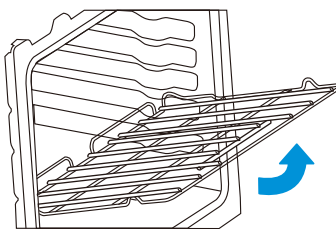

Inserting Rack: The rack can be installed in only one direction.

To insert the rack:

1. Orient the rack so that the handle is towards the front and the interlock features are on the top side.
2. Tip rack so that the front is several inches higher than the back.
3. Slip the interlock features under the stop position on the rack guides formed in the oven walls.
4. Rotate rack down while pushing back to complete the insertion process.

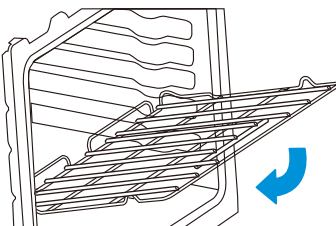

NOTE: The extension rack frame inserts into the rack guides formed into the oven wall in the same manner as the flat rack. Be careful to hold the extension rack firmly so that the ball bearings do not slide during the removal/insertion process.

Rack Positions:

For best performance, adjust rack so food is placed at the center of the oven. For most foods this will be rack position #4. For larger foods like roasts and turkey, move the rack position down to #3 or #2 to keep the food centered in the oven. When using multiple racks simultaneously, try to space the food out around the oven center (rack position #3 and #5 for two racks). Broiling performs best with the food close to the broil burner - typically rack position #6 or #7.

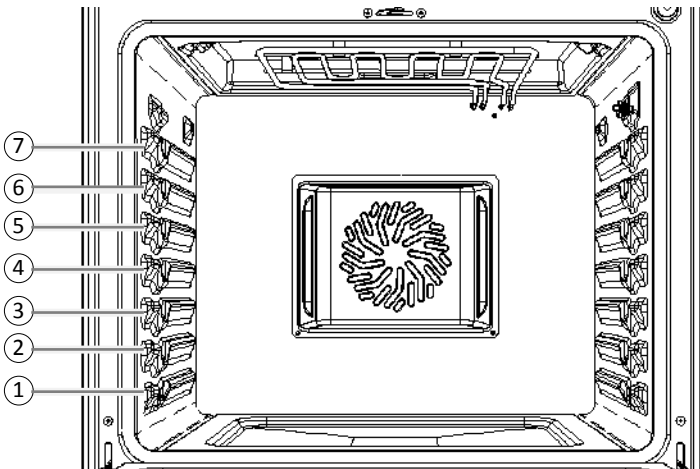

Preheating:

For oven modes that require preheating, the control will automatically enter preheat mode after START/ENTER is pressed. Preheating is generally desirable, although not absolutely necessary in all circumstances. Some foods are more robust and may have acceptable results without preheating. These foods include large pieces of meat (whole roasts, hams, or poultry) where the total cooking time is much longer than the time required to preheat. These foods also include frozen potato products and frozen processed dinners that, by their nature and design, are more robust to baking variations. More delicate foods, such as breads (including cakes, cookies, pastries, and pizzas), desserts, soufflés, etc. will likely not have acceptable results without proper preheating.

If a baking mode (Bake, Convection Bake, Convection Roast, Pizza, etc.) utilizes preheat, after START/ENTER is pressed, the temperature display will show the current oven temperature. The display will continue to show the oven temperature increasing until the set temperature is reached. Once the set temperature is reached, the control will beep to alert the user that preheat is complete.

Bake:

Designed for general baking recipes, BAKE applies heat from both above and below to achieve exceptional baking performance. Works best for small- and medium-sized foods that require only one rack position at the center of the oven, such as casseroles, frozen dinners, single-layer cakes, and individual racks of cookies.

Directions:

1. Press the BAKE button.
2. The control will default to 350°F (175°C). If desired, and depending on your model, use either the numeric keypad or the available knob to adjust the desired oven temperature.
3. Press the START/ENTER button or click the Control Input Knob (if present).
4. Allow oven to preheat before placing food in oven. Higher temperatures will take longer to preheat. Oven display will show oven temperature as it increases. Control will beep when preheat is complete.
5. Press CLEAR/OFF to exit.

Keep Warm (some models):

⚠ WARNING

FOODBORNE ILLNESS HAZARD

Bacteria may grow in food at temperatures below 140°F. Do not attempt to cook food using the KEEP WARM mode. This mode is designed to keep cooked foods warm, not to heat cold foods.

Designed for keeping hot foods hot. Cover dishes to prevent from drying out. For best results, do not use KEEP WARM for more than 2 hours.

Directions (6-knob models):

1. Press the KEEP WARM button.
2. Press the START/ENTER button.
3. Press CLEAR/OFF to exit.

Directions (4-knob models):

1. Press the BAKE button twice.
2. Press the START/ENTER button.
3. Press CLEAR/OFF to exit.

Broil:

NOTE: FOR BEST EXPERIENCE

- The broil heating element is very powerful. Follow recipe directions and monitor food closely to reduce risk of burning food.
- For broiling meat, it is recommended to use a broiling pan to allow grease and juices to drain away from the meat. Do not line broiling pan with aluminum foil, as this will prevent greases from draining properly.
- This is a "closed-door broil" system. Broil will not operate with the door open. If the door is left open, an alert will sound to close the door. If the door is not closed, the broil mode will ultimately cancel itself.

Designed to provide similar results to grilling, BROIL is a method of cooking that exposes food to direct radiant heat. BROIL can be used to cook steaks or other foods where a seared exterior is preferred. It can also be used in short durations to brown tops of casseroles or melt cheese. BROIL performs best with food placed closest to heating element, typically at rack position #6 or #7, depending on the size of the dish.

Directions:

1. Press the BROIL button.
2. The control will default to high broil. To select low broil, press the BROIL button again. (The difference between high broil and low broil is small and will only be noticed on recipes of longer duration.)
3. Press the START/ENTER button.
4. Allow broil to operate for 5-10 minutes before placing food in the oven. No preheat beep will sound.
5. Press CLEAR/OFF to exit.

Proof (some models):

Designed to use the oven lights to provide a gently warm environment for the rising of bread or roll dough. In order to not kill the yeast in the dough, this mode will not start if the oven temperature is too warm. If the mode will not start, allow dough to rise on the kitchen counter. Generally, PROOF performs best with food at rack position #4. After dough has risen as desired, bake according to recipe directions. The word PROOF will be shown below the clock in the control display when this mode is active.

Directions (6-knob models):

1. Press the PROOF button.
2. Press the START/ENTER button.
3. Preheat is not required - place food in the oven immediately.
4. Press CLEAR/OFF to exit.

Directions (4-knob models):

1. Press the BAKE button three times.
2. Press the START/ENTER button.
3. Preheat is not required - place food in the oven immediately.
4. Press CLEAR/OFF to exit.

Convection Bake:

Designed for baking recipes that require the use of multiple racks, such as 4-layer white cakes, multiple racks of cookies, or baking multiple recipes simultaneously. CONVECT BAKE performs best with racks spaced evenly out from center of oven (see section on rack positions).

Directions:

1. Press the CONVECT BAKE button.
2. The control will default to 350°F (175°C). If desired, and depending on your model, use either the numeric keypad or the available knob to adjust the desired oven temperature.
3. Press the START/ENTER button.

Special instructions for baking four cake layers simultaneously:

1. Use convection bake mode.
2. Place racks at positions 3 and 5.
3. Place layers on rack 5 towards the back of the oven, and layers on rack 3 towards the front of the oven so that one pan is not directly above another.

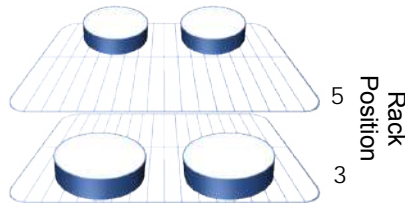

Special instructions for Air-Frying and getting crispy foods from your oven:

1. Place oven rack at position 6 (closer to broiler).
2. Press CONVECT BAKE button.
3. The control will default to 350 F (175 C). Adjust temperature based on the food to cook (see attached chart).
4. Press the START/ENTER button or click the Control Input Knob (if present).
5. Allow oven to preheat before placing food in oven. Higher temperatures will take longer to preheat. Oven display will show oven temperature as it increases. Control will beep when preheat is complete.
6. Use any flat, non-stick cookie sheet
7. Adjust time, temperature, or rack position based on your preferences.
8. Place food inside the oven and cook per recommended time. (see chart below).

Foods Recommended	Temp [°F]	Cook Time [min]
Frozen Fries	475	20
Fresh Fries*	475	18
Frozen Wings	450	45
Fresh Wings	450	35
Frozen Mozzarella Sticks	475	6
Frozen Chicken Nuggets	440	12
Brussel Sprouts	440	15
Breaded Chicken Breasts	440	30

NOTE: For more even and crispy results, flip foods half way through the cooking time.

Convection Roast (some models):

Designed for cooking large pieces of meat, such as roast, ham, turkey, or chicken. CONVECT ROAST performs best with the rack position adjusted to place the center of the meat at the approximate center of oven.

Directions:

1. Press the CONVECT ROAST button.
2. The control will default to 350°F (175°C). If desired, and depending on your model, use either the numeric keypad or the available knob to adjust the desired oven temperature.
3. Press the START/ENTER button.
4. Allow oven to preheat before placing food in oven. Higher temperatures will take longer to preheat. Oven display will show oven temperature as it increases. Control will beep when preheat is complete.
5. Press CLEAR/OFF to exit.

Pizza (some models):

Designed to optimize the cooking of fresh pizza. Fresh pizza can be homemade or purchased from many grocery stores or specialty shops.

Directions:

1. Press the PIZZA button.
2. The control will default to 350°F (175°C). If desired, and depending on your model, use either the numeric keypad or the available knob to adjust the desired oven temperature.
3. Press the START/ENTER button.
4. Allow oven to preheat before placing food in oven. Higher temperatures will take longer to preheat. Oven display will show oven temperature as it increases. Control will beep when preheat is complete.
5. Press CLEAR/OFF to exit.

Delay (some models):

WARNING

FOODBORNE ILLNESS HAZARD

Foods that spoil easily, such as milk, eggs, fish, stuffing, poultry, and pork, should not be allowed to sit for more than 1 hour before cooking. Spoilage may occur sooner if oven is warm.

Designed to allow user to delay the start of a baking operation until a specified time of day. Works only with BAKE, KEEP WARM, CONV BAKE, CONV ROAST, PROOF, SELF CLEAN, and STEAM CLEAN. (Does NOT work with PIZZA or BROIL.) Once DELAY has been set, it cannot be

modified - oven operation must be cancelled and restarted from the beginning to set a different DELAY value. DELAY cannot be set for more than 12 hours in advance.

Directions:

1. Place food in the oven.
2. Select oven baking mode by pressing the appropriate button (i.e. BAKE, CONV BAKE, etc.)
3. Press the DELAY button.
4. Clock will begin to flash, indicating that a time of day to start the oven must be entered. Enter the time of day when the oven is to begin operation and press the START/ENTER button.
5. Display will alternate between the current time of day and the time when the oven will turn on.
6. When the start time is reached, a signal will alert user that oven is starting.
7. Upon starting, the display will convert to show the normal information for the bake mode selected.

Cook Time (some models):

Designed to allow user to end oven operation after a specified time. Works only with BAKE, KEEP WARM, CONV BAKE, or CONV ROAST. Once a COOK TIME has been set, it can not be modified - baking mode must be cancelled and restarted from the beginning to set a different COOK TIME. Duration cannot be set for longer than 12 hours. Can be used in conjunction with DELAY feature - set DELAY feature first (see above), and then set COOK TIME.

Directions:

1. Start oven operation normally as described above.
2. Press the COOK TIME button.
3. Clock will display "00:00" indicating that a time duration must be entered. Enter time in hours and minutes (hh:mm) and press the START/ENTER button.
4. Clock will begin to count down. When "00:00" is reached, oven will flash the display and alert user with an audible signal. Oven will either turn off or revert to KEEP WARM mode, depending on the settings. See Control Settings section of this manual for instructions on changing settings.) Allow oven to preheat before placing food in oven. Higher temperatures will take longer to preheat. Oven display will show oven temperature as it increases. Control will beep when preheat is complete. Press COOK TIME to clear the signal after timed bake ends, or press
6. CLEAR/OFF to exit the timed bake early.

Probe (some models):

⚠ WARNING

FOODBORNE ILLNESS & BURN HAZARDS

- Consuming undercooked food can result in foodborne illness. Use probe feature only according to the following instructions to ensure all portions of the food reach minimum safe cooking temperatures. Consult reputable government sources, such as USDA, FDA, or CDC, for recommended safe minimum cooking temperatures.
- Check the internal temperature at multiple locations with a food thermometer after cooking to ensure that all portions of the food have reached the minimum safe internal temperature for that food.
- If oven has been preheated, use oven mitts to open the receptacle and insert probe to avoid burn injury.
- Use only the probe supplied with your oven - do not use any accessories not specifically designed to work with your appliance.

Designed to work in conjunction with BAKE, CONVECT BAKE, or CONVECT ROAST, the oven probe supplied with your oven can monitor the internal food temperature and turn off the oven when the food reaches the desired temperature. Some foods, particularly small or thin items, are not suited for cooking with the probe due to their size or shape. Position rack at optimal position prior to preheating or initiating the PROBE function.

Common Directions (works with all models):

1. Place meat in an appropriate baking dish or pan. Insert meat probe into meat. Use only the probe provided with your appliance. To avoid damage to the probe, meat should be completely defrosted prior to inserting probe.

SAFETY INSTRUCTIONS
PREPARING FOR FIRST USE
COOKTOP OPERATION
OVEN OPERATION
CONTROL SETTINGS
CLEANING AND MAINTENANCE
TROUBLESHOOTING

- A. Position probe so that the tip is in the approximate center of the thickest part of the food. For whole poultry, insert the probe into the thickest part of the breast.
 - B. For best results, insert at a point that allows as much of the probe to be inserted into the food as possible.
 - C. The probe should not touch bone, fat, or gristle.
2. Place baking dish into oven, plug probe into receptacle, and close the door. Preheating is not required.

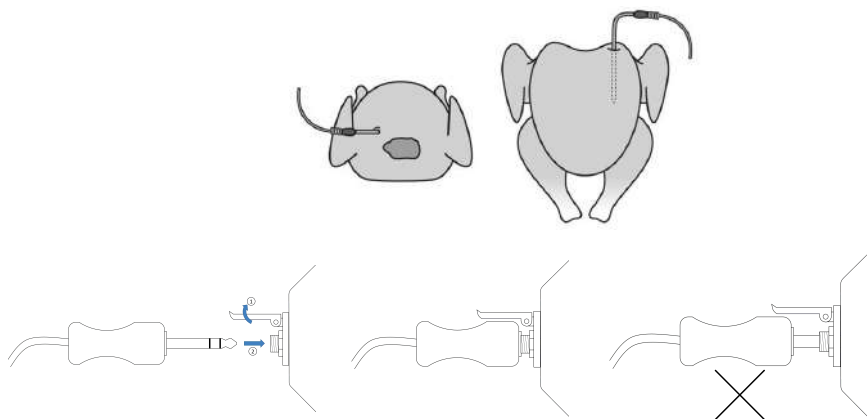

3. Select the baking mode (BAKE, CONV BAKE, or CONV ROAST), select oven temperature, and press the START/ENTER button or click the Control Input Knob (if present).
4. Once oven temperature has been set, the blue text and probe icon will flash indicating that the desired food temperature is to be set next. Adjust food temperature to the desired value and press START/ENTER.
5. While the probe mode is in operation, the display will alternate between the oven set temperature and the probe temperature reading.
6. Once the oven probe reaches the desired temperature, the display will flash and sound an alert to indicate the bake mode has ended. Oven will either turn off or revert to KEEP WARM mode, depending on the settings. (See Control Settings section of this manual for instructions on changing settings.)
7. Press PROBE to clear the signal after probe bake ends, or press CLEAR/OFF to exit the probe bake early.

Modifying the probe temperature:

1. On Control Input Knob models with a separate PROBE key on the oven control, pressing this key allows user to change the desired food temperature at which the bake cycle will end.
2. Press PROBE button, set food temperature to the desired value, and press START/ENTER. Control will begin to beep, indicating that probe needs to be connected to oven.

Designed to allow kosher oven usage during Jewish Sabbath and holidays. When in Sabbath Mode, the oven operation may be controlled as described below, however audible signals will not sound, the clock is disabled, oven lights are disabled, and changes to the display may be delayed from 30 to 60 seconds. (There is no need to remove oven lightbulbs during Sabbath Mode.) The oven will be allowed to operate indefinitely until Sabbath Mode is exited, overriding the factory 12-hour default maximum continuous oven operation. Baking during Sabbath Mode is a two-step process; first the Sabbath mode must be selected and then the bake mode must be set.

Entering Sabbath Mode:

1. Select the SETTINGS button, select the **SABE** option, and turn this setting to "ON." See "Settings" under "Preparing for First Use" at the beginning of this manual for more information on adjusting settings.
2. A single bracket "]" will appear in the display, indicating that Sabbath Mode is active.

Controlling the Oven:

1. During Sabbath Mode, the function of the buttons on the control are modified to perform the functions described in the diagrams below
2. For continuous baking operation, select the button corresponding to the desired oven temperature, then press the START/ENTER button.
3. For a timed baking operation, select the button corresponding to the desired oven temperature, then select the button corresponding with the operating time, then press the START/ENTER button.
4. After having pressed the START/ENTER button, a random delay between 30 and 60 seconds will pass, and a second bracket "]" [" will appear in the display, indicating that the oven has started baking.

- Temperature can be adjusted at any time by pressing the button corresponding to the desired oven temperature, then pressing the START/ENTER button.
- Press the CLEAR/OFF button to cancel any baking operation in progress. After a random delay between 30 and 60 seconds, the display will return to a single bracket "[]".

Control Input Knob models:

Function During Sabbath Mode:	BAKE	BROIL Hi / Low	CONVECT BAKE	PIZZA	STEAM CLEAN
	Bake 200F	Bake 250F	Bake 300F	Bake 350F	Bake 400F
	KEEP WARM	PROOF	CONVECT ROAST	PROBE	SELF CLEAN
	90 minutes	2 hours	3 hours	4 hours	5 hours

Numeric Keypad Input models:

Function During Sabbath Mode:	1	2	3	4	5
	Bake 200F	Bake 250F	Bake 300F	Bake 350F	Bake 400F
	6	7	8	9	0
	90 minutes	2 hours	3 hours	4 hours	5 hours

Exiting Sabbath Mode:

- Quickly press the SETTINGS button three times to reopen the settings menu.
- Locate the Sabbath Mode setting, and change this setting to OFF.

NOTE: If a power outage occurs while in Sabbath Mode, when power is restored the appliance will return to Sabbath Mode, but it will not resume any baking operations that may have been in progress.

Steam Clean (some models):

⚠ CAUTION

BURN HAZARD

- Oven surfaces - especially oven bottom - may be hot. Use caution to avoid contact with hot surfaces.
- Hot surfaces may create hot steam in wet sponge or cloth while cleaning. If steam is evident when wiping out oven, wait until oven has cooled slightly.

Designed to generate steam and gently warm the oven surfaces to loosen grease and light soils.

Directions:

1. Start with oven at room temperature.
2. Remove all items from oven, including oven racks.
3. Wipe out any large spills or excess debris prior to starting steam clean. Scrape off and remove any burnt-on debris with a stiff plastic utensil (hard plastic spatula, plastic paint scraper, old credit card, etc.)
4. For improved softening of tough stains, spray inside surfaces with water spray bottle or wipe surfaces with a wet sponge before starting.
5. Place 1 cup (8 oz.) of water in the center bottom of the oven and close the door.
6. For 6-knob model, press STEAM CLEAN button. For 4-knob model, press CLEAN button once.
7. Press START/ENTER button or clicking the Control Input Knob (if present).
8. Depending on the model, the oven door may lock during steam clean. If oven door does not lock, do not open the door until the steam clean cycle has completed fully.
9. After steam clean cycle is complete, soak up any remaining water from oven bottom and wipe down surfaces within oven with soft, damp sponge or cloth.
10. Press CLEAR/OFF to exit at any time.

Self Clean:

WARNING

FIRE & BURN HAZARDS

- When using the self-clean function, confirm that the door locks and will not open. If the door does not lock, do not run self-clean. Contact a qualified service provider for repairs
- To avoid ignition inside the oven, clean excess grease or food out of the oven before starting self-clean.
In the event of ignition inside the oven during self-clean, turn off the oven and wait for the fire to extinguish. **DO NOT FORCE THE DOOR OPEN.** Wait for the oven to cool before removing contents and cleaning the oven.
- See also other warnings in the "Self Clean Hazards" section at the beginning of this manual before using Self Clean.

NOTE: FOR BEST EXPERIENCE

- Due to the high temperatures generated, it may be preferable to delay using the self clean feature until the weather is colder to avoid unnecessarily burdening the home air conditioning system.

- Your oven can be set to operate self clean for 3, 4, or 5 hours. This time does not include the time required for the oven to cool down and unlock.
- Shorter times use less energy, but longer times generally provide more thorough cleaning. To conserve energy, use shorter times for light to moderate soiling, and use longer times only for heavy soiling.

Designed to generate very high oven temperatures that are capable of reducing stubborn oven soils to ash that can be easily wiped out after the oven has cooled.

Directions:



1. Remove all items from oven, including oven racks.
2. Wipe out any large spills or excess debris prior to starting self clean.
3. For 6-knob model, press SELF CLEAN button. For 4-knob model, press CLEAN button twice.
4. Select the number of hours you wish self clean to operate and press START/ENTER button or clicking the Control Input Knob (if present).
5. Oven door will lock while self clean is performed.
6. After oven has unlocked and cooled completely, wipe out any ashy residue with a damp, non-abrasive sponge or cloth.
7. Press CLEAR/OFF to exit at any time. If self-clean is cancelled early, the oven will remain locked until it has cooled sufficiently.





(Remote Operation):

Allows use of most oven functions using a connected smart device, such as smart phone or tablet. Remote operation has two modes: Manual and Auto Recipe. Manual mode allows you to turn on/off selected oven operations manually using a smart device. Auto Recipe mode allows you to program a series of oven operations that will sequence and end automatically according to the settings selected.

Provides the ability to monitor oven and cooktop operation, and control selected oven functions. Follow the instructions in the app for more details.

 must be enabled at the range control before remote operation can be used. See app connection instructions in the "Preparing for First Use" section in this manual. The connected  icon in the display section (located left of the clock) will indicate your connection status and whether remote operation is enabled:

1. Icon is off: WiFi has not been turned on. Press the  icon to turn on WiFi capability
2. Icon is flashing slowly: WiFi has been turned on, but it is not connected. Follow the instructions under "Preparing for First Use" in this manual.
3. Icon is flashing quickly: WiFi is in the process of connecting to your home network. Follow app instructions.
4. Icon is solid: WiFi has successfully connected to your home network, and the range can now be controlled via the MSmartLife app.

Directions: Simply press the  button to activate or deactivate the WiFi functionality. To disable remote operation from smart devices, deactivate the WiFi feature.

Timer:

Midea ovens come equipped with a built-in kitchen timer function for your convenience.

Directions:

1. Press TIMER button.
2. Clock will display "00:00". Enter time in hours and minutes (hh:mm) and press START/ENTER button or clicking the Control Input Knob (if present).
3. Clock will begin to count down. When "00:00" is reached, timer will signal. Cancel or clear the timer function by pressing the TIMER button. (CLEAR/OFF is reserved for canceling baking modes only.)

Oven Light:

Controls the oven lights.

Directions: Simply press the LIGHTS button to cycle oven lights on and off.

CONTROL SETTINGS

Settings:

Midea ovens are provided with a variety of settings available to help you customize the appliance to your personal preferences. The ability to adjust settings is only available when no other oven operation is in progress.

Navigation of the settings menu:

1. Enter the settings menu by pressing the "SETTINGS" button on the control panel. The first menu option will be displayed in white (flashing) with the current setting displayed in blue (solid).
2. Depending on your model, use the selector knob or "+" and "-" buttons to navigate between menu options.
3. Use START/ENTER button or clicking the Control Input Knob (if present) to select a menu option to be adjusted. The menu option selected will turn solid, and the blue setting will begin to flash indicating the setting can now be adjusted.
4. Depending on your model, use the selector knob or "+" and "-" buttons to adjust the setting value.
5. Use START/ENTER button or clicking the Control Input Knob (if present) to confirm modification to setting value, use SETTINGS or CLEAR/OFF buttons to reject modifications and return to the menu options level.
6. Press SETTINGS or CLEAR/OFF again to exit the settings menu entirely.



Oven Calibration - If you find your oven is running hotter or colder than expected based on the outcome of recipes with which you are very familiar, the oven calibration setting allows you to offset oven's target temperature in order to achieve the results you desire. Calibration can be offset between -25 and +25 degrees Fahrenheit. Default offset is zero.



Clock-Only present on models where no dedicated CLOCK button is available on the control. Used to set the time of day on the display clock.

DEG

Degree Units - Your oven is programmed by default to use degrees Fahrenheit, but it can be set to operate in degrees Celsius using this setting.

DISP

Display Brightness - The user interface is programmed by default to operate at maximum brightness. If desired, you can reduce the brightness of the display using this setting. Reducing the brightness will reduce the standby energy usage of the oven control and could extend the life of the display.

hold

Hold After Cook - When using the timed bake or probe function, by default the oven will turn off when the bake mode ends. You have the option to have the oven switch to KEEP WARM at the end of a timed bake function by altering this setting.

Sabb

Sabbath Mode - For customers who observe the Jewish Sabbath, selecting this mode will place the range into an operating mode that observes kosher law for oven operation. Complete details on the operation of Sabbath Mode are found in a dedication section within this manual.

Vol

Volume - The audible feedback of the control is programmed by default to operate at the maximum level. If desired, you can reduce the volume using this setting.

SALE

Demo (Sales) Mode - This sets the appliance for "demo mode." In this mode, the controls will function as normal but will not allow any cooking mode to be initiated. This is intended to be used only by retailers on showroom floors, and is not intended to be used once the appliance has been purchased. By default, demo mode is off.

CLEANING AND MAINTENANCE

⚠️ WARNING

Tip-Over Hazard

- If range is moved for cleaning, servicing, or any other reason, confirm the anti-tip device is engaged per the installation instructions.
- A child or adult can tip the range and be killed.
- Failure to follow these instructions can result in death or serious burns to children and adults.



Confirm leveling leg is engaged with anti-tip bracket

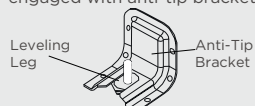

See installation instructions for details

Glass Cooktop:

⚠️ CAUTION

LACERATION, SHOCK, BURN, INHALATION HAZARDS

- Glass cooktop is durable, but may break when heated if scratched or otherwise damaged during cleaning. Clean only as described below to avoid glass breakage.
- Clean cook-top with caution - To avoid steam burns, do not use wet sponge or cloth while cooking area is hot. Wear oven mitt if cleaning with razor while cooktop is hot (see special instructions below for sugary spills and melted plastic).
- Some cleaners can produce noxious fumes if applied to a hot surface. Allow cooktop to cool completely before applying any cleaning chemicals.

For best results and prolonged cooktop life, it is recommended to clean the cooktop after each use.

Light soiling:

- Clean with general purpose kitchen cleaner, followed by glass cleaner to remove streaks.

Moderate soiling:

- Commercially available glass cooktop cleaners may be used. Follow instructions on product packaging.

Heavily burned on residue:

- Clean using commercially available glass cooktop cleaner. Follow instructions on product packaging.
- Use a razor blade scraper designed for cleaning glass surfaces. Ensure razor is clean and new to minimize risk of scratching cooktop.
- Hold razor at approximately 45° angle, apply firm pressure, and smooth press razor through residue.
- After heavy residue is removed, clean again using glass cooktop cleaner compound.

Sugary spills/plastic - Sugary spills and melted plastics may cause damage the cooktop not covered by warranty if not removed immediately.

- Turn off all cooktop heating elements and remove all cookware from cooktop.
- As described above, use a clean, new razor blade scrape and wear oven mitt for protection to quickly remove sugary spills or melted plastic from cooktop glass while cooktop is hot.
- Quickly wipe removed material away from hot cooktop heating element using dry paper towel.
- Wait until the cooktop glass has completely cooled before attempting a more thorough cleaning as described above.

Control Panel:

CAUTION

ELECTRIC SHOCK HAZARD

- Do not use excessive amounts of water or cleaners to clean knob areas. If moisture is forced into openings behind knobs, there is a potential for electric shocks.
- Avoid spraying kitchen cleaners directly into the openings behind knobs.

NOTICE

TO PREVENT COSMETIC DAMAGE

Do not use scouring pads, abrasive cleaners, strong liquid chemicals, steel wool, or oven cleaners, as these may damage the control panel finish. For best results, it is recommended to clean the user interface and control panel after each use. Control knobs can be removed for easier cleaning. Ensure knobs are in the "OFF" position before removing. Pull straight back with a firm pressure to remove knob from stem. Clean entire panel with a lightly damp soft cloth using mild soap and water. Glass cleaner can be used on oven control to remove streaks. Stainless steel cleaner can be used on the exposed metal to remove streaks. Knobs should be washed by hand in warm soapy water - do not wash in dishwasher. Wait until knobs are dry before placing back on stem. Be sure to align profile in knob to stem shape to ensure smooth fit and avoid damage to knob or control.

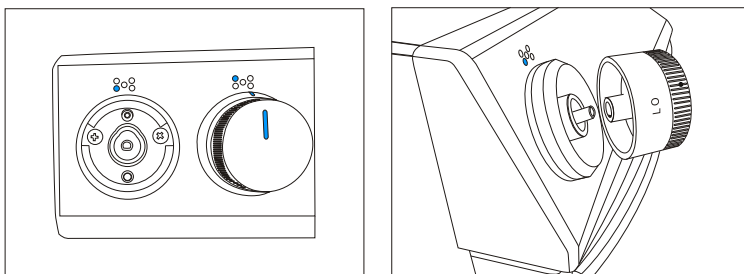

Oven Interior:

⚠ CAUTION

BURN HAZARD

- Oven surfaces - especially oven bottom - may be hot. Use caution to avoid contact with hot surfaces.
- Hot surfaces may create hot steam in wet sponge or cloth while cleaning. If steam is evident when wiping out oven, wait until oven has cooled.

Check oven after each use to determine if any spills or splattering occurred that require cleaning. Wipe out oven interior with a lightly damp soft cloth using mild soap and water to remove light spills. Follow the STEAM CLEAN instructions under "Oven Operation" to remove moderate soiling. For stubborn or heavy soiling, follow the SELF CLEAN instructions under "Oven Operation."

Oven Lights:

⚠ CAUTION

SHOCK, BURN, AND LACERATION HAZARDS

- Disconnect power to oven and wait until oven is cool before attempting to service light bulbs.
- Handle glass cover carefully to reduce risk of breakage. If lamp cover is difficult to remove, do not force. Contact a qualified service provider for repairs.
- Do not operate oven without glass cover in place.

Oven lamps are located in the top of the oven, close to the oven door. To replace the light bulb, first twist glass cover to unscrew it from base. Light bulb can be removed by pulling firmly straight out from the light socket. Replace bulb only with G8 style 120V halogen bulb rated 25W or less. Twist glass cover back onto lamp socket before using oven.

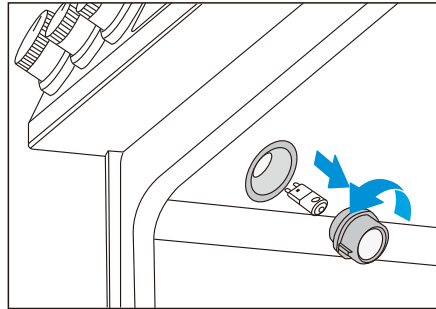

Drawer:

Clean drawer by wiping down interior surfaces with soft, damp, non-abrasive sponge or cloth. Removal of drawer is not required for cleaning, but can be done if desired. To remove drawer, fully extend drawer and operate the release levers on each side while pulling lightly on drawer.

To reinstall the drawer, align the rails on the drawer with the slides on the range and push drawer in until fully closed. Open and close drawer to ensure slide rails are operating properly.

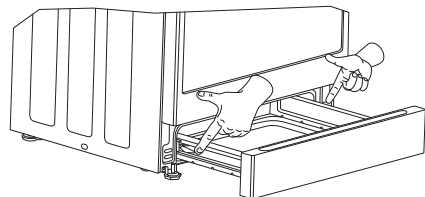

Door:

WARNING

FIRE HAZARD

- If door is removed, confirm that door operates correctly and seals properly when reinstalled. If door gasket does not seal completely, heat escaping from around doors could ignite cabinetry.
- To maintain proper door seal during baking operations and self clean, do not rub or clean the door gasket. It has a very low resistance to abrasion.
- If the gasket becomes worn, frayed, or damaged in any way, contact a qualified service provider for repair

NOTICE

TO PRESERVE APPEARANCE

- To prevent streaking of internal door glass, do not allow excess water or spray cleaner to enter any holes or slots in the door.
- Do not use scouring pads, abrasive cleaners, strong liquid chemicals, steel wool, or oven cleaners, as these may damage the door finish

Clean door as frequently as desired to remove dust, splatter, and fingerprints. Wipe door surfaces with a lightly damp soft cloth using mild soap and water. Burned-on residue on interior door glass can be cleaned with glass cleaning compound and/or razor scraper - see "Glass Cooktop" section above for instructions. Enameled portions of the door interior can be cleaned using soapy water and a non-abrasive sponge. Glass cleaner can be used on door glass to remove streaks. Stainless steel cleaner can be used on the exposed metal to remove streaks.

Door can be removed for easier cleaning, servicing, or installation:

1. Open door fully.
2. On each door hinge, flip up the lock mechanism so that it engages with the oven face when the door is rotated towards being closed.
3. Once both lock mechanisms are engaged, continue to rotate door until -2-3 inches from being fully closed.
4. Grasp door firmly from the sides and lift door up and out from oven face. Do not lift door by door handle to reduce risk of broken door glass.

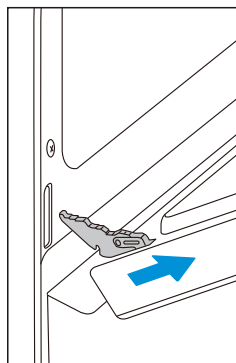
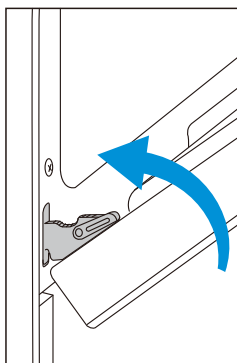
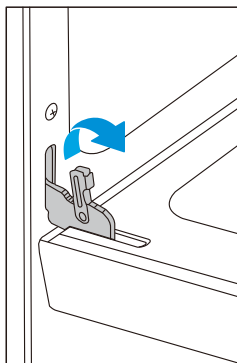

Reinstalling door:

1. Holding door from the sides, align door so that hinges slip back into openings and door drops into notches on hinges.
2. Rotate door out until fully open.
3. Secure the hinge locking mechanisms back down into hinges.
4. Check that door opens and closes correctly.
5. If door does not operate correctly, re-engage locking mechanisms, remove door, and reattempt installation.

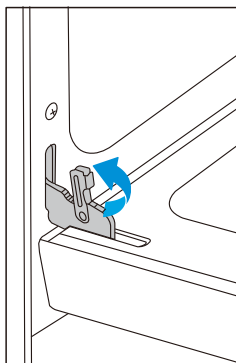
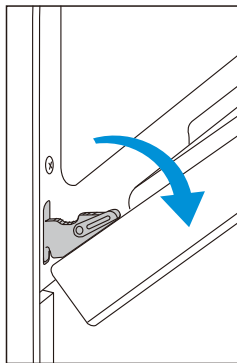
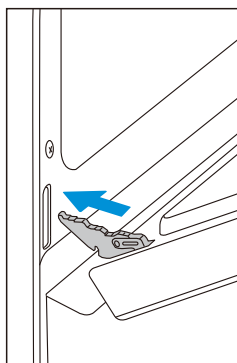

TROUBLESHOOTING







(read before calling for service)

Midea is committed to providing you with a quality appliance that works as expected. If you find something that is not working as anticipated, check the table below for helpful hints and advice that might save you the time and expense of calling for repair.

Cooktop:

Problem:	Possible Reason:
MSmartLife app will not control cooktop	Cooktop cannot be controlled through MSmartLife app.
Unable to maintain a rolling boil or will not cook fast enough.	Improper cookware - Only use pans with flat bottoms and that match the diameter of the cooktop heating element selected. Large pots and pans can lose a lot of heat from the top - cover pan with a lid to retain heat better.
Cooktop will not operate.	If control panel display is not lit, appliance may not be receiving power - check circuit breaker or fuse has not tripped and that cord is properly plugged in.
Cooktop heating element does not glow steadily.	This is normal - cooktop heating element will cycle off/on to maintain the power level selected at the knob. This is normal even on the highest setting.
Cooktop heating element does not glow when power level is reduced.	This is normal - cooktop heating element will begin cycling again once the heating element has cooled slightly.
Cooktop glass is scratched.	Incorrect cleaning method used - scratches cannot be removed, but further scratching can be avoided by following the cleaning instructions in this manual. Cookware with rough bottom has been used or cookware has been slid across cooktop - scratches cannot be removed, but further scratching can be avoided by ensuring cookware is flat-bottomed, smooth, clean, and not slid across cooktop.
Cooktop is discolored.	Cooktop is not cleaned thoroughly - see section in this manual on care and cleaning of cooktop.
Cooktop is pitted.	Sugary spill has occurred on hot glass - this cannot be repaired. Service must be called to replace the cooktop glass.

Oven:

Problem:	Possible Reason:
Unable to use MSmartLife app to control oven	If WiFi signal icon  is flashing slowly, WiFi has not been connected. See instructions in "Preparing For First Use."
	If WiFi signal icon  is flashing quickly, WiFi signal has been lost. Check that router is on and no obstructions are hindering signal. Can try to reset router and wait 15 minutes to reconnect. Otherwise repeat connection instructions in "Preparing For First Use."
	If WiFi signal icon  is off,  enabled. Press the  button to en icon  will turn on.
Strong "burning" or "oily" odor when using new oven.	This is normal with a new range and will disappear after a few uses. Still, to be careful, you should double-check that all packaging has been removed from the appliance - check around door sides and inside drawer.
Control is dark and will not respond	If control panel display shows only "]" or "[", the control is in Sabbath Mode. Refer to that section for how to operate control and how to exit Sabbath Mode.
Control is on but will not respond	Check that CONTROL LOCK has not been activated.
	Turning power off and back on at the breaker box can usually reset the oven control and clear response issues.
Oven door is locked and will not open.	If self-clean recently finished, this is normal. Wait for the oven to cool fully and it will unlock. Otherwise, try resetting the appliance by cycling the circuit breaker off and on.
Condensation on door glass	This is normal. Condensation will evaporate as oven heats up.
Door will not close properly	Door is not installed properly. See instructions on removing and re-installing door in "Cleaning and Maintenance" section.
Oven is taking too long to cook.	All ovens operate slightly differently from each other. Adjust oven calibration upwards to make oven cook faster. See "Control Settings" section of this manual.
Food is overcooked.	All ovens operate slightly differently from each other. Adjust oven calibration downwards to reduce overcooking. See "Control Settings" section of this manual.
Food is not baking evenly - top gets done faster/slower than bottom.	Make sure you are using the recommended rack settings. See "Rack Positions" at the start of the "Oven Operation" section.
	Recipe may perform better at different rack position. Try moving food down a rack position to make the bottom darker. Try moving food up a rack position to make the top darker.

Problem:	Possible Reason:
Oven light is not working	Oven light may be burned out. Follow instructions in "Cleaning and Maintenance". If display also show "J" or "J[" then Sabbath Mode setting must be turned off.
The oven will not start self-clean	If oven was in use recently, this is normal. Self-clean can only be initiated when the oven has cooled sufficiently.
	If cooktop is in use, self-clean cannot be started. This is normal.
Metal "popping" sounds during self-clean.	This is normal as the extreme temperatures cause the metal frame to expand.
Oven not clean after a self-clean cycle.	After self-clean, the remaining white/grey ash must still be wiped out by hand.
	If black soiling still remains, oven may have been too heavily soiled to clean with the settings selected. Rerun self-clean using the longest possible setting.
	Some areas, such as bottom door corners, may be too cool to turn soils into ash. These areas may need to be cleaned by hand.
Convection fan runs in modes other than convection	This may be normal - convection fan typically runs during preheat to ensure oven is evenly preheated. Convection fan also runs in Convection Bake, Convection Roast, Pizza, and Steam Clean
Hot air is coming from the openings at the back of the cooktop	This is normal - the oven vents out and a cooling fan also discharges hot air from the openings at the back of the cooktop.
Smoke or steam is coming from the openings at the back of the cooktop.	It is normal for steam to be released from the oven vent at the back of the cooktop. If the exhaust has no smell (or smells like normal baking food), do not be alarmed.
	If the exhaust smells like burning food, check that the food is not burning and that there is no spillage or splattering in the oven that may be producing the smoke.
	If the oven is in self-clean, this may be normal. Monitor progress of self-clean to ensure smell is only the result of soiling in the oven cavity being converted to ash.
Cooling fan continues to run after oven has been turned off	If the exhaust smells like anything else is burning (plastic, wood, etc.), turn oven off and make sure smoking stops. Contact a qualified service provider for repairs
	This is normal to prevent remaining oven heat from damaging controls. Fan will turn off when oven is sufficiently cool.
"E" and a number appears in display	This is a error code. Press CLEAR/OFF to clear the display and stop beeping. If necessary, reset power to the oven by cycling circuit breaker off and on. If error code remains or repeats, write down error code and contact a qualified service provider for repairs

WARRANTY

MIDEA RANGE LIMITED WARRANTY

ATTACH YOUR RECEIPT HERE. PROOF OF PURCHASE IS REQUIRED TO OBTAIN WARRANTY SERVICE.

Please have the following information available when you call the Customer Service Center:

- Name, address and telephone number
- Model number and serial number
- A clear, detailed description of the problem
- Proof of purchase including dealer or retailer name and address

IF YOU NEED SERVICE:

1. Before contacting us to arrange service, please determine whether your product requires repair. Some questions can be addressed without service. Please take a few minutes to review the Troubleshooting section of the User Manual, or visit <http://Midea.com/us/support>
2. All warranty service is provided exclusively by our authorized Midea Service Providers, in the U.S. and Canada.

Midea Customer Service

In the U.S.A. or Canada, call 1-866-646-4332.

If outside the 50 States of the United States or Canada, contact your authorized Midea dealer to determine whether another warranty applies.

LIMITED WARRANTY

WHAT IS COVERED

FIRST YEAR LIMITED WARRANTY (PARTS AND LABOR)

For one year from the date of purchase, if this major appliance is installed, operated and maintained according to instructions attached to or furnished with the product, Midea America Corporation (hereafter "Midea") will pay for factory specified replacement parts and repair labor to correct defects in materials or workmanship that existed when this major appliance was purchased, or at its sole discretion replace the product. In the event of product replacement, your appliance will be warranted for the remaining term of the original unit's warranty period.

YOUR SOLE AND EXCLUSIVE REMEDY UNDER THIS LIMITED WARRANTY SHALL BE PRODUCT REPAIR OR REPLACEMENT AS PROVIDED HEREIN. Service must be provided by a Midea designated service company. This limited warranty is valid only in the 50 States of the United States or Canada and applies only when the major appliance is used in the country in which it was purchased. This limited warranty is effective from the date of original consumer purchase. Proof of original purchase date is required to obtain service under this limited warranty.

LIMITED WARRANTY

WHAT IS NOT COVERED

1. Commercial, non-residential or multiple-family use, or use inconsistent with published user, operator or installation instructions.
2. In-home instruction on how to use your product.
3. Service to correct improper product maintenance or installation, installation not in accordance with electrical codes or correction of household electrical system (i.e. house wiring, fuses, etc.).
4. Consumable parts (i.e. light bulbs, batteries, air or water filters, etc.)
5. Defects or damage caused by the use of non-genuine Midea parts or accessories.
6. Damage from accident, misuse, abuse, fire, floods, electrical issues, acts of God or u with products not approved by Midea.
7. Repairs to parts or systems to correct product damage or defects caused by unauthorized service, alteration or modification of the appliance
8. Cosmetic damage including scratches, dents, chips, and other damage to appliance finishes unless such damage results from defects in materials and workmanship and i reported to Midea within 30 days.
9. Routine maintenance of the product.
10. Products that were purchased "as is" or as refurbished products.
11. Products that have been transferred from its original owner.
12. Discoloration, rust or oxidation of surfaces resulting from caustic or corrosive environments including but not limited to high salt concentrations, high moisture or humidity or exposure to chemicals.
13. Pick-up or delivery. This product is intended for in-home repair.
14. Travel or transportation expenses for service in remote locations where an authorized Midea servicer is not available.
15. Removal or reinstallation of inaccessible appliances or built-in fixtures (i.e. trim decorative panels, flooring, cabinetry, islands, countertops, drywall, etc.) that interfere with servicing, removal or replacement of the product.
16. Service or parts for appliances with original model/serial numbers removed, altered or not easily identified

The cost of repair or replacement under these excluded circumstances shall be borne by the customer.

DISCLAIMER OF IMPLIED WARRANTIES

IMPLIED WARRANTIES, INCLUDING ANY IMPLIED WARRANTY OF MERCHANTABILITY OR IMPLIED WARRANTY OF FITNESS FOR A PARTICULAR PURPOSE, ARE LIMITED TO ONE YEAR OR THE SHORTEST PERIOD ALLOWED BY LAW. Some states and provinces do not allow limitations on the duration of implied warranties of merchantability or fitness, so this limitation may not apply to you. This warranty gives you specific legal rights, and you also may have other rights that vary from state to state or province to province.

DISCLAIMER OF REPRESENTATIONS OUTSIDE OF WARRANTY

Midea makes no representations about the quality, durability, or need for service or repair of this major appliance other than the representations contained in this warranty. If you want a longer or more comprehensive warranty than the limited warranty that comes with this major appliance, you should ask Midea or your retailer about buying an extended warranty.

LIMITATION OF REMEDIES; EXCLUSION OF INCIDENTAL AND CONSEQUENTIAL DAMAGES

YOUR SOLE AND EXCLUSIVE REMEDY UNDER THIS LIMITED WARRANTY SHALL BE PRODUCT REPAIR AS PROVIDED HEREIN. MIDEA SHALL NOT BE LIABLE FOR INCIDENTAL OR CONSEQUENTIAL DAMAGES. Some states and provinces do not allow the exclusion or limitation of incidental or consequential damages, so these limitations and exclusions may not apply to you. This warranty gives you specific legal rights, and you also may have other rights that vary from state to state or province to province.



make yourself at home

Parsippany, NJ, 07054

If appliance is not working as expected, please contact Midea customer service at:

1-866-646-4332

or

<http://midea.com/us/support>

A large, dark gray circular graphic with a thick border, partially open at the top and bottom, framing the text inside.

Free 3 months
extension* of the
original limited warranty
period! simply text a
picture of your proof of
purchase to:

1-844-224-1614

*The warranty extension is for the
three months immediately following
the completion of the product's
original warranty period.

Document No.: XXXXXXXX

Rev. XX - 03/20

© Midea Group, 2020