

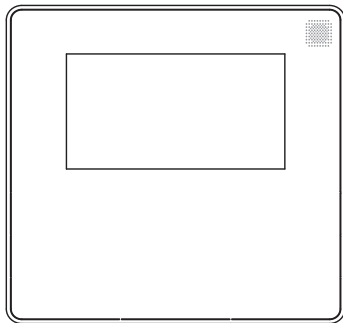

Installation and Owner's Manual



Wired Thermostat

IMPORTANT:

Read this manual carefully before installing or operating your wired remote controller. Save this manual for future reference.

Version Date: 12-03-21

This manual gives detailed description of the precautions that should be brought to your attention during operation.

In order to ensure correct service of the wired controller, please read this manual carefully before using the unit.

All the illustrations in this manual are for explanatory purpose only. There may be slightly differences from the wired remote controller you purchased (depending on model). The actual shape shall prevail.

Keep this manual for future reference.

Table of Contents

1. Safety Precautions.....	1
2. Installation Accessories	2
3. Installation Method	4
4. Specification	12
5. Features and Functions	13
6. Wired Controller LCD	14
7. Wired Controller Buttons	15
8. Pre Operation	16
9. Operation	17
10. Timer Functions	26
11. Weekly Timer 1	29
12. Weekly Timer 2	35
13. Fault Alarms	42
14. Technical Indication and Requirement.....	42
15. Queries and Settings	43

1. Safety Precaution



WARNING

- Please entrust a professional to install the unit. Installation by a non qualified individual may lead to incorrect installation, electrical shock, or fire.
- Adhere to this installation manual.
- Improper installation may lead to electric shock or fire.
- Re installation must be performed by professionals.

Do not uninstall the unit randomly.

Random uninstallation may lead to abnormal operation, heating or fire.

NOTE

- Do not install the unit in a place vulnerable to leakage of flammable gases. Once flammable gases are leaked and left around the wire controller, fire could occur.
- Do not operate with wet hands or let water enter the wire controller. Otherwise, electric shock could occur.
- The wiring should adapt to the wire controller current. Otherwise, electric leakage or heating may occur and result in fire.

1. Safety Precaution

NOTE

For wiring, only use the cables specified. The terminal should not be subjected to any external force. Otherwise, the wire may be damaged, resulting in a fire.

2. Installation Accessories

Select the Installation Location

Don't install in a location where heavy oil, vapor or sulfated gas is present. Otherwise, this product could deform and lead to system malfunction.

Preparation before installation

1. Please confirm that the following parts have been supplied.

No.	Name	Qty.	Remarks
1	Wire controller	1	_____
2	Installation and owner's manual	1	_____
3	Screws	3	M3.9X25 (For Mounting on the Wall)
4	Wall plugs	3	For Mounting on the Wall
5	Screws	2	M4X25 (For Mounting on switch box)
6	Plastic screw bars	2	For fixing on switch box
7	Battery	1	
8	The connective wires group	1	Optional
9	Screw	1	M4X8(For Mounting the connective wire group)

2. Installation Accessories

2. Prepare the following assemblies on the site.

No.	Name	Qty.(embedded into wall)	Specification (only for reference)	Remarks
1	Switch box	1	_____	_____
2	Wiring Tube(Insulating Sleeve and Tightening Screw)	1	_____	_____

Installing the wire controller - Precautions

1. This manual provides installation instructions for the wired controller. Please refer to the wiring diagram included in this installation manual to connect the wire controller to the indoor unit.
2. The wired controller works in a low voltage loop circuit. **DO NOT** directly contact the cable to high voltage (115V, 220V). Keep a clearance between the flex or rigid conduit at 12-20 inches (300-500mm) or above.
3. The shielded cable of the wired controller must be firmly grounded.
4. **DO NOT** use an insulation resistance tester.

3. Installation Method

1. Wired remote controller structural dimensions

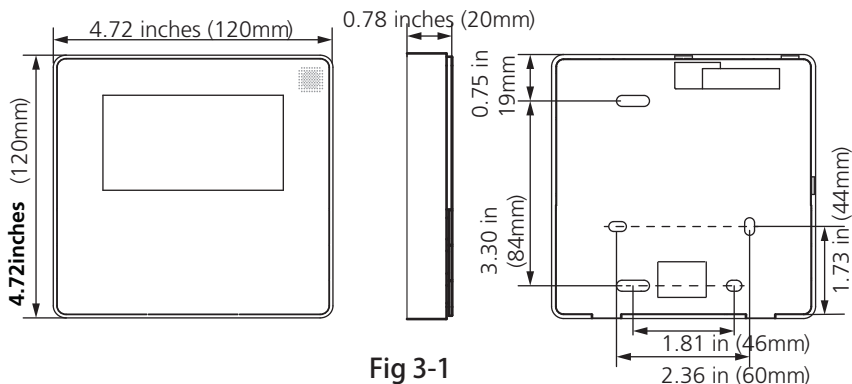

2. Remove the front cover of wired controller

- Insert a flat head screwdriver into the slots located at the bottom of the wired controller (2 places). Remove the front cover of the wire controller. (Fig.3-2)

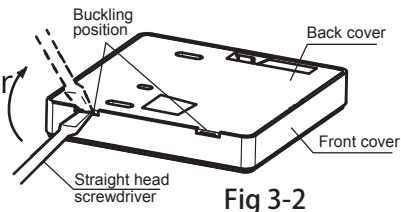

NOTE: The Printed Circuit Board (PCB) is mounted in the upper part of the wired controller. Be careful not to damage the board with the flat head screwdriver.

3. Installation Method

3. Fasten the back plate of the wired controller

- For exposed mounting, fasten the back plate to the wall with the 3 screws (M4×20) and plugs. (Fig.3-3)

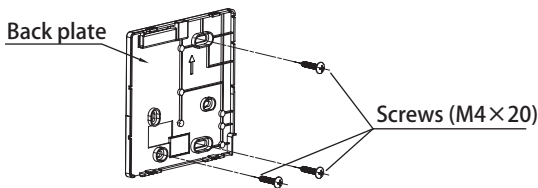

Fig 3-3

- Use two M4X25 screws to install the back cover on the 86 switch box, and use one M3.9X25 screw to attach to the wall.

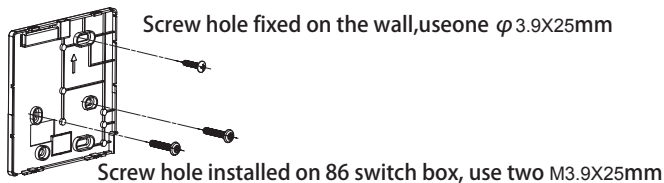

Fig 3-4

3. Installation Method

NOTE: Attach to a flat surface. Be careful not to distort the back plate of the wire controller by over-tightening the mounting screws.

4. Battery installation

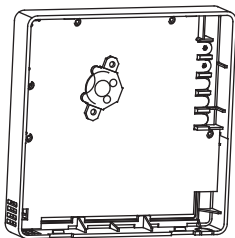

Fig 3-5

- Put the battery into the installation site and make sure the positive side of the battery is in accordance with the positive side of installation site. (See Fig.3-5)
- Set the correct time during first time operation.
- Batteries in the wire controller can keep time under a power failure. When the power is restored, the time displayed should be correct. If it is incorrect, replace the battery and reset the time.

3. Installation Method

5. Wire with the indoor unit

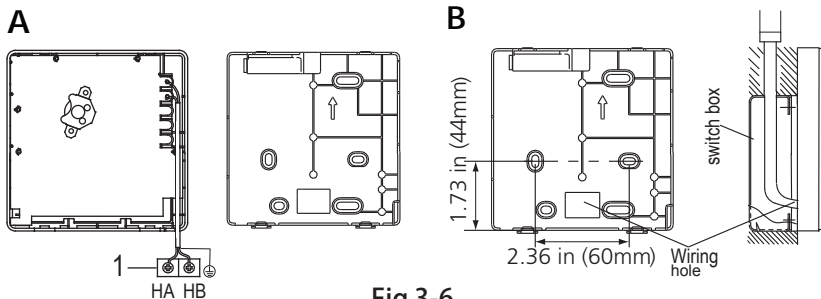

Fig 3-6

1 Indoor unit

2 Notch the part for the wiring to pass through with pliers or similar tool. Connect the terminals on the remote controller (HA ,HB), and the terminals of the indoor unit (HA ,HB). (HA and HB do not have polarity.) See Fig. 3.7

NOTE:

- DO NOT allow water to enter the wire controller .
Use the trap and putty to seal the wires.
- Connecting wires must be fixed and cannot be pulled.

3. Installation Method

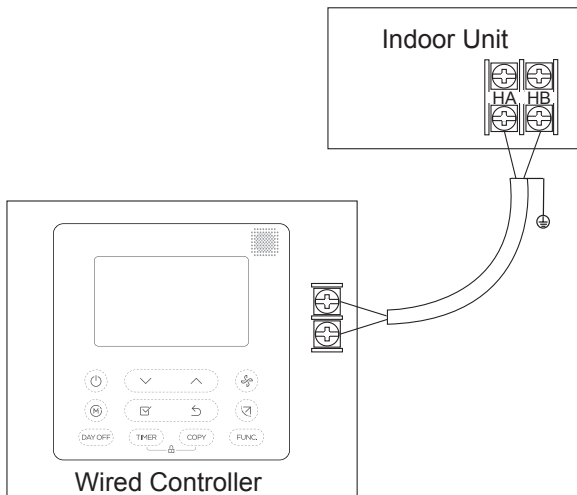

Fig.3-7

3. Installation Method

The main/secondary wired controller can be used to enable two wired controllers to control one unit. The wired controllers connect to the unit HA and HB ports through the HA and HB port on the controller. There is no polarity between HA and HB. See Fig. 3-8

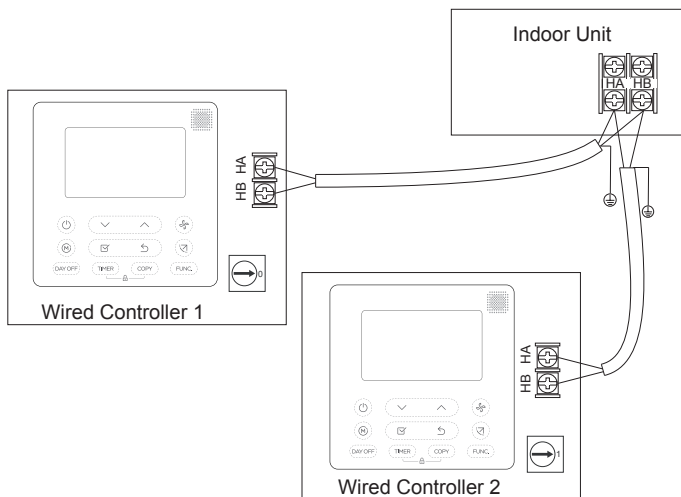

Fig.3-8

3. Installation method

For some units, one wired controller can support multiple units (a maximum of 16 units). In this case, the wired controller and unit need to be connected to the HA and HB ports at the same time. **Please note: In group control, there will be no errors displayed on the wired controller.** See Fig. 3-9

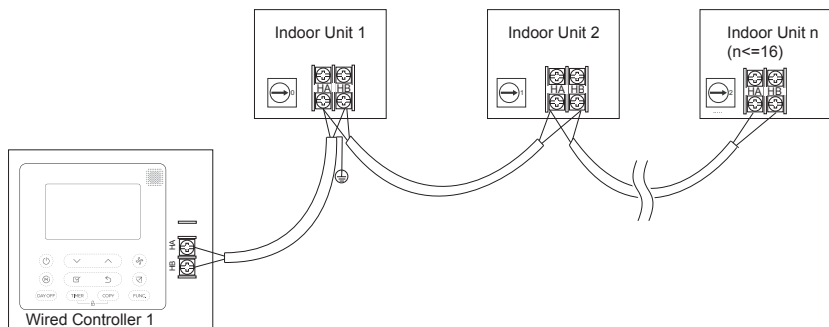

Fig.3-9

3. Installation method

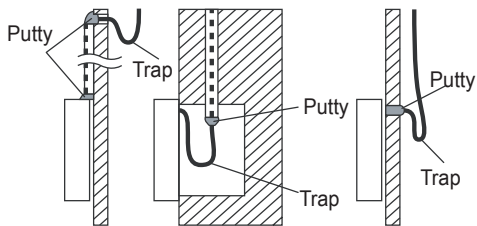

Fig 3-10

6. Reattach the front face of the wired controller

- Avoid accidental clamping of the wiring when reattaching the front face of the controller. (Fig 3-11)

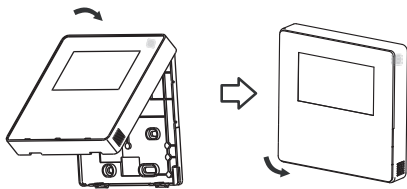

Fig 3-11

The illustrations in this manual are for explanatory purposes only. Your actual controller design may vary from what is shown here.

4. Specification

Input voltage	DC 12V
Ambient temperature	-5~43C (23~110F)
Ambient humidity	RH40%~RH90%

Wiring specifications

Wiring type	Size	Total length
shielded cable	0.5mm ²	≤20m (66')
	0.75-1.25mm ²	≤50m (164')

5. Features and Functions

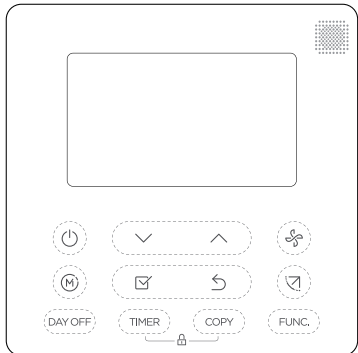

Feature:

- LCD display.
- Error code display
- 4-way wire layout design
- Room temperature display.
- Weekly Timer

Function:

- Mode: Auto-Cool-Dry Heat Fan
- Fan speed: Auto/Low/Med/High speed Swing(on some models)
- Timer ON/OFF
- Temp setting
- Weekly timer
- Follow me
- Turbo
- 24-hour System
- 12-hour System
- Sleep
- 8 degree heating function (on some models)
- Auto-restart
- Individual louver control (on some models)
- Automatic airflow test
- Rotation&Back-up
- Dual Control
- Group Control
- Child Lock
- LCD display
- Clock

6. Wired Controller LCD Display

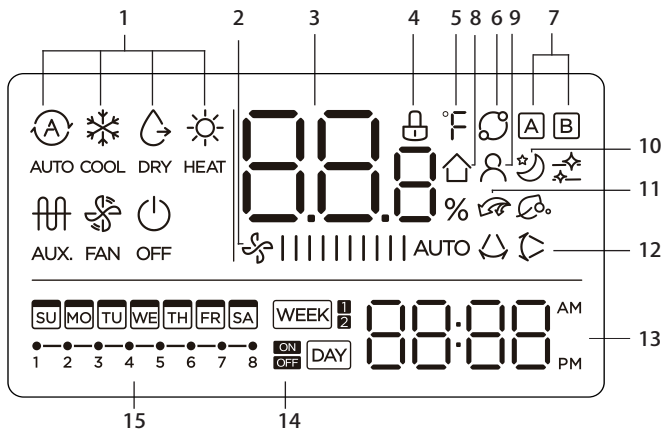

- | | |
|--|---|
| 1 Operation mode indication | 9 Follow Me function indication |
| 2 Fan speed indication | 10 Sleep mode indication |
| 3 Temperature display | 11 Electric Auxiliary Heat/
Turbo function indication(some models) |
| 4 Lock indication | NOTE: AHU models only have turbo functions. |
| 5 °C / °F indication | 12 Left-right swing indication
(some models) |
| 6 Rotating indication | 13 Clock display |
| 7 Main unit and secondary
unit indication | 14 On/Off timer |
| 8 Room temperature indication | 15 Timer display |

7. Wired Controller Buttons

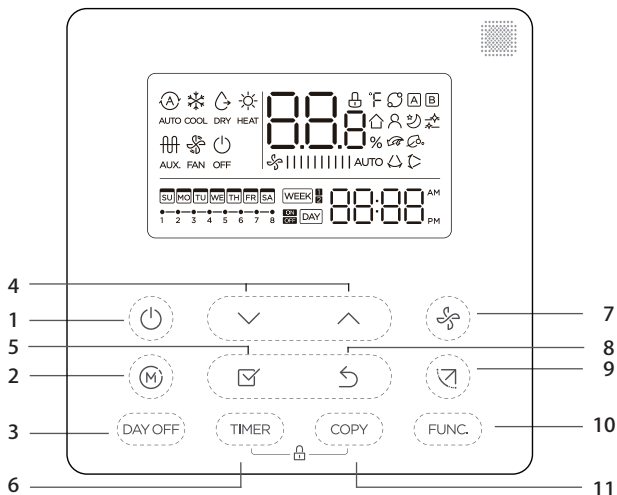

- | | |
|----------------------|--------------------|
| 1 POWER button | 6 TIMER button |
| 2 MODE button | 7 FAN SPEED button |
| 3 DAY OFF/DEL button | 8 BACK bottom |
| 4 ADJUST button | 9 SWING bottom |
| 5 CONFIRM button | 10 FUNC. button |
| | 11 COPY button |

8. Pre-Operation



Set the current day and time

- 1  Press the Timer button for 2 seconds or more. The timer display will flash.
-

- 2  Press the button “ \checkmark ” or “ \wedge ” to set the date. The selected date will flash.
-



- 3  To complete this process, press the Timer button or CONFIRM button. If no button is pressed within 10 seconds, the process will automatically complete.
-

- 4  Press the button “ \checkmark ” or “ \wedge ” to set the current time. Press repeatedly to adjust the current time in 1-minute increments. Press and hold to adjust the current time continuously.
- 



A rectangular digital display with a small 'MO' icon in the top left corner and the time '11:20' in the center.
- ex. Monday 11:20
-

- 5  To complete this process, press the Timer button or CONFIRM button. If no button is pressed within 10 seconds, the process will automatically complete.

9. Operation

6



Time scale selection
Press the buttons "  " and "  " for 2 seconds will alternate the clock time display between the 12h & 24h scale.

To start/stop operation



Press the power button.

8 degree heating function (on some models)



When the heating mode is 60°F (16°C)/62°F (17°C), press the down button twice within 1 second to turn on the 8° heating function, and press the Power, Mode, Adjust, Fan speed, Timer, and Swing button to cancel the 8° heating function.

NOTE:

For some models, the 8° heating function can only be set by remote control, you can not choose this function by wired controller.

9. Operation

To set the operation mode

Operation mode setting



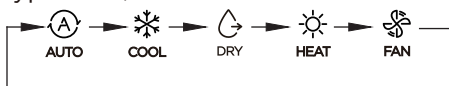

Press the Mode button to set the operation mode. (Heat function is invalid for cool only type unit)



For AHU models:



- When the mode is selected as emergency heating (single-on electric auxiliary heating) mode,  is displayed. In the mode area, the fan speed will display automatic wind. The fan speed key will not respond.
- Sleep, 8-degree heating, and turbo functions do not work in emergency heating mode.
- When the mode is selected as heating + electric auxiliary heating mode,  is displayed in the mode area, and there is no turbo function.

9. Operation

Room temperature setting

Press the button "∨" or "∧" to set the room temperature.

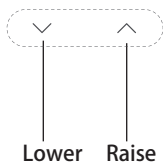

Indoor Setting Temperature Range :

60~86°F (16-30°C) / 62~86°F (17~30°C) or according to the set temperature range of the unit.

°C & °F scale selection(on some models)

Pressing the buttons "∨" and "∧" for 3 seconds will alternate the temperature display between the °C & °F scale.

Fan speed setting



Press the Fan speed button to set the fan speed. (This button is unavailable when in the mode of Auto or Dry)

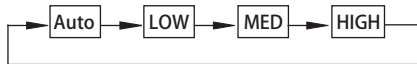

Keypad tone setting



Press the buttons Swing and FUNC. for 3 seconds to close the keypad tone.

Press the buttons again for 3 seconds to open the keypad tone.

9. Operation

Child lock function



Press the buttons “” and “” for 2 seconds to activate the child lock function and lock all buttons on tests the wire controller.

Press the buttons again for 2 seconds to deactivate the child lock function.

When the child lock function is activated, the  mark appears.

Swing function (For the unit left & right auto swing models only)

1 Up-Down swing



Press the SWING button to start up-down swing function. Press it again to stop.

When the Up-Down swing function is activated, the  mark appears.

2 Left-Right swing

Press the Swing button long to start Left-Right swing function. Press it again to stop. When the Left-Right swing function is activated, the  mark appears.

9. Operation

Swing function (For the unit without left & right auto swing function models)

Up-Down airflow direction and swing



- Use Swing button to adjust the Up-down airflow direction.



1. Press the button to swing the louver in 6 degree increments.
2. Press and hold the button for 2 seconds, it turns into up-down swing mode, press it again to stop. When the Up-Down swing function is activated, the  mark appears. (Not applicable to all the models)

To operate functions in following instructions for the unit with four Up-Down louvers can be operated individually.

1. Press the Swing button to activate the Up-Down adjusting louver function.



The  mark will flash. (Not applicable to all the models)

2. Pressing the button " " or " " can select the movement of four louvers. Each time you push the button, the wire controller select in a sequence that goes from: (the icon  means the four louvers move at the same time.)

9. Operation



3. Use the Swing button to adjust the Up-Down airflow direction of the selected louver.



Press the FUNC. button to set the turbo or rotating or lfeel function.



The select function icon will flash. Then press the Confirm button to confirm the setting.

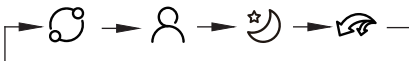

Sleep function



In automatic, cooling or heating mode, press the FUNC. button to select the sleep icon, and then press the OK button to operate the sleep function, and set the wind speed to display as automatic wind.

After the sleep function is turned on, turning on turbo, 8-degree heating, switching modes, or adjusting the wind speed will cancel the sleep function.

9. Operation

Turbo function (on some models)



Under COOL/HEAT mode, press the FUNC. button to activate the turbo function. Press the button again to deactivate the turbo function.

When the turbo function is activated, the  mark appears. In heating mode, if there is a PTC, turn on the PTC function.

NOTE: The electric auxiliary heating function of the AHU model is switched by the MODE button, and the FUNC. button is a turbo function.

Follow me function indication

Press the FUNC. button to select whether the room temperature is detected at the indoor unit or the wire controller.

When the follow me function indication appears, the room temperature is detected at the wire controller. 

Press the button again to cancel the follow me function.

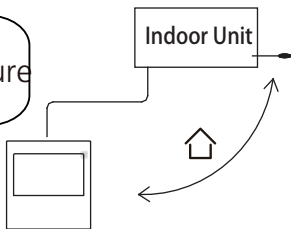

9. Operation

Rotation & Back-up indication

When there are two units, press the button to select the rotating function, and press "Confirm" to turn on or off the rotating function.

1. Press "Confirm" to set the rotating time, then press the button " \vee " or " \wedge " to set the time. Setting time Range : 1~99h. The default time is 10 hours.
2. Step 2, set high temperature co-open temperature -- or 26~32 degrees -- that is, this function is invalid. When the ambient temperature is 26~32 degrees or when the ambient temperature is greater than or equal to the set temperature, the two machines will run 24 degrees at the same time in the COOL mode.
3. Step 3, set the low-temperature co-open temperature -- or 5-15 degrees -- that is, this function is invalid. When the ambient temperature is 5-15 degrees, when the ambient temperature is lower than the set temperature, the two machines will run at the same time for 24 degrees to make the heating mode.

9. Operation

4. Step 4: set which machine will run first. Select A or B.
5. After this function is turned on, it will automatically turn on another air conditioner and turn off the current air conditioner (as long as the air conditioner is running at the setting hour). Press the POWER button to switch to another one immediately. A or B icons flicker to indicate the corresponding air conditioning failure.
Automatically switch to another machine when the running time is reached or machine failure occurs.

10. Timer functions

WEEK

WEEKLY timer

Use this timer function to set operating times for each day of the week.

ON

DAY

On timer

Use this timer function to start air conditioner operation. The timer and air conditioner operation will start after the set time has been reached.

OFF

DAY

Off timer

Use this timer function to stop air conditioner operation. This function will stop air conditioner operation after the set time has been reached.

ON

OFF

DAY

On and Off timer

Use this timer function to both start and stop air conditioner operation. The timer operates and air conditioner operation starts and stops when the set times have been reached.

10. Timer functions

To set the On or Off TIMER

- 1 Press the Timer button to select the  or .



- 2 Press the CONFIRM button and the Timer display will flash.



ex: The Off timer set at 18:00 (6:00 PM)



Press the button "∨" or "∧" to set the time. After the time is set, the timer will start or stop automatically.

- 4 Press the CONFIRM button again to confirm the settings.





10. Timer functions

To set the On and Off TIMER

-  Press the TIMER button to select the  .

-  Press the CONFIRM button and the Clock display will flash.

- 
 Press the button “∨” or “∧” to set the time of the On timer, and then press the CONFIRM button to confirm the setting.

-  Press the button “∨” or “∧” to set the time of the Off timer.

-  Press the CONFIRM button to confirm the settings.

NOTE: The secondary wired controller cannot set the timer.

11. Weekly Timer 1

1 Weekly timer setting



Press the Timer button to select the **WEEK** and then press the CONFIRM button to confirm the selection.



2 Day of the week setting



Press the button "∨" or "∧" to select the day of the week and then press the CONFIRM button to confirm the setting.



3 Set ON timer of timer setting 1



Press the button "∨" or "∧" to set the time of the On timer and then press the CONFIRM button to confirm the setting.



11. Weekly Timer 1



ex: Tuesday time scale 1

Up to 4 timer settings can be saved for each day of the week. It is convenient if the WEEKLY TIMER is set according to the user's lifestyle.

4 Set OFF timer of timer setting 1



Press the button "∨" or "∧" to set the time of the Off timer and then press the CONFIRM button to confirm the setting.



ex: Tuesday time scale 1

- 5 Different timer settings can be set by repeating steps 3 & 4.
6 Other days of one week can be set by repeating step 2-5.

NOTE: The weekly timer setting can be returned to the previous step by pressing BACK button. The time of the timer setting can be deleted by pressing DAY OFF button. The current setting will be restored and the weekly timer setting withdrawn automatically when there is no operation for 30 seconds.

11. Weekly Timer 1

WEEKLY timer operation

To activate the WEEKLY TIMER operation:

 Press the Timer button while **WEEK**  is displayed on the LCD.

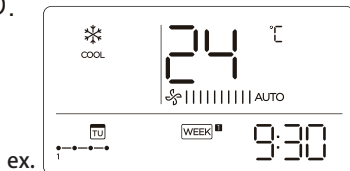

To deactivate the WEEKLY TIMER operation

 Press the TIMER button while the **WEEK**  is displayed on the LCD and it will disappear.

To turn off the air conditioner during the weekly timer

 1. If you press the POWER button once quickly, the air conditioner will turn off temporarily. The air conditioner will turn on automatically at the set time of On timer.

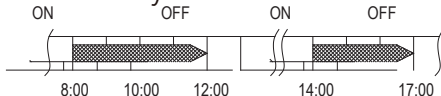





ex: If you press the POWER button once quickly at 10:00, The air conditioner will turn on at 14:00.

2. When you press the POWER button for 2 seconds, the air conditioner will turn off completely, and at the same time cancel the timing function.

11. Weekly Timer 1

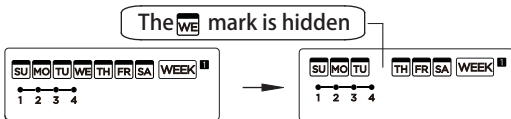
To set the DAY OFF setting (for a holiday)

-  During the weekly timer, press the CONFIRM button.
-  Press the button “∨” or “∧” to select the day in the week.
-  Press the DAY OFF button to set the DAY OFF.

ex: The DAY OFF is set for Wednesday
- The DAY OFF can be set for other days by repeating the steps 2 & 3.
-  Press the BACK button to go back to the weekly timer.

To cancel: Follow the same procedures as those used for setup.

NOTE:

The DAY OFF setting is canceled automatically after the set day has passed.

11. Weekly Timer 1

DELAY function



During the weekly timer, pressing the DAY OFF/DEL button once and "0h" will display. Press it twice and "1h" will display. Wait 3 seconds to confirm and the system will override for 1 hour. Press the button three times and "2h" will display. After waiting 3 seconds to confirm the system will override for 2 hours.

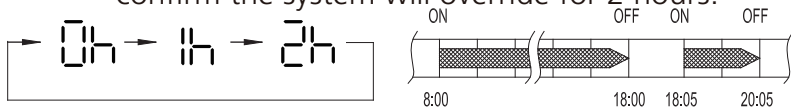

Ex: If you press the DAY OFF/DEL button to select "2h" at 18:05. The air conditioner will delay to turn off at 20:05.

Copy the setting from one day into another day.

A timer setting made once can be copied to another day of the week. All of the timer settings of the selected day of the week will be copied. The effective use of the copy mode ensures ease of making weekly settings.



During the weekly timer, press the CONFIRM button.



Press the button "✓" or "∧" to select the day to copy from.

11. Weekly Timer 1

3  Press the COPY button, the letters "Cy" will be displayed on the LCD.

4  Press the button "∨" or "∧" to select the day to copy to.

5  Press the COPY button to confirm.

The  mark flashes quickly

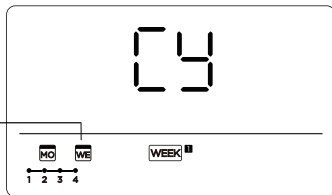

ex: Copy the setting of Monday to Wednesday

6 Other days can be copied by repeating step 4 & 5.

7  Press the CONFIRM button to confirm the settings.

8  Press the BACK button to return back to the weekly timer.

12. Weekly Timer 2

1 Weekly timer setting

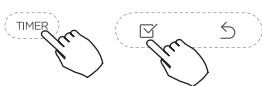

Press **TIMER** to select the **WEEK** and press **CONFIRM**.

2 Day of the week setting



Press " \vee " or " \wedge " to select the day of the week and then press **CONFIRM**



3 ON timer setting of timer setting 1



Press " \vee " or " \wedge " to select the set time. The set time, mode, temperature and fan speed will appear on the LCD display. Press **CONFIRM** to enter the set time screen.



12. Weekly Timer 2

IMPORTANT: Up to 8 scheduled events can be set on one day. Various events can be scheduled in either **MODE**, **TEMPERATURE** and **FAN** speeds.

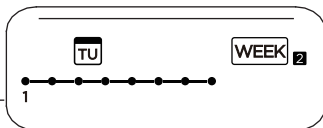

ex. Tuesday time scale 1

4 Time setting



Press "∨" or "∧" to set the time then press CONFIRM.



5 Operation mode setting



Press "∨" or "∧" to set the operation mode then press CONFIRM.

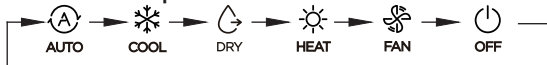

NOTE: the specific mode changes will vary based on the model/unit installed.

6 Room temperature setting



Press "∨" or "∧" to set the room temperature then press CONFIRM.



NOTE: This setting is unavailable in the FAN or OFF modes.

12. Weekly Timer 2

7 Fan speed setting



Press “ \vee ” or “ \wedge ” to set the fan speed then press CONFIRM.



NOTE: This setting is unavailable in the AUTO, DRY or OFF modes.

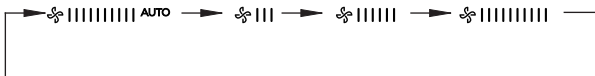

8 Different scheduled events can be set by repeating steps 3 through 7.

9 Additional days, in a one week period, can be set by repeating steps 3 through 8.

NOTE: The weekly timer setting can be returned to the previous step by pressing BACK. The current setting is restored. The controller will not save the weekly timer settings if there is no operation within 30 seconds.

12. Weekly Timer 2

WEEKLY timer operation

To start



Press Timer to select the **WEEK** , and then the timer starts automatically.

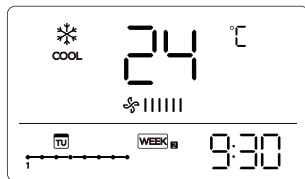

ex.

To cancel



Press the Power buttons for 2 seconds to cancel the timer mode.

The timer mode can also be canceled by changing the timer mode using Timer.

To set the DAY OFF (for a holiday)

1



After setting the weekly timer, press CONFIRM.

2



Press "∨" or "∧" to select the day of the week.

12. Weekly Timer 2

3 Press DAY OFF to create an off day.



ex.The DAY OFF is set for Wednesday

4 Set the DAY OFF for other days by repeating the steps 2 and 3.

5  Press BACK to revert to the weekly timer.

To cancel, follow the same procedures used for setup.

NOTE: The DAY OFF setting is cancelled automatically after the set day has passed.

Copy out the setting from one day to another day.

A scheduled event, made once, can be copied to another day of the week. The scheduled events from the selected day of the week will be copied. Copy mode makes the reservation process easier.

1  In the weekly timer, press CONFIRM.

12. Weekly Timer 2

2  Press "∨" or "∧" to select the day to copy from.

3  Press COPY, the letters CY appear on the LCD.

4  Press "∨" or "∧" to select the day to copy to.

5 Press COPY to confirm.

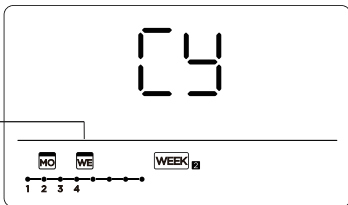

The **WEBK** makes quickly

ex. Copy the setting of Monday to Wednesday

6 Other days can be copied by repeating steps 4 and 5.

7  Press CONFIRM to confirm the settings.

8  Press BACK to revert to the weekly timer.

12. Weekly Timer 2

Delete the time scale in one day.



During the weekly timer setting, press CONFIRM.

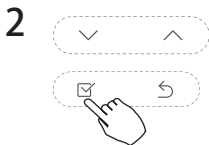

Press “∨” or “∧” to select the day of the week and then press CONFIRM.



Press “∨” or “∧” to select the time to be deleted. The setting time, mode, temperature and fan speed appear on the LCD. The setting time, mode, temperature and fan speed can be deleted by pressing the DEL (day off).

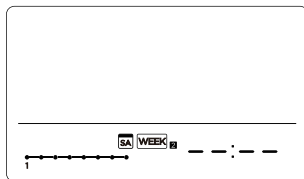
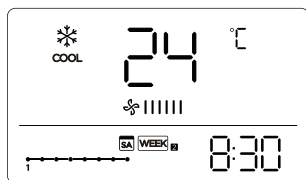

ex. Delete the time scale 1 in Saturday

13. Fault Alarms

If the system does not operate properly, review the previously mentioned cases for possible malfunction causes or investigate the system fault codes according to the following procedures.

NO.	MALFUNCTION & PROTECTION DEFINE	DISPLAY DIGITAL TUBE
1	Error of communication between wire controller and indoor unit	E463

If the error displayed on the wire controller are different from those on the unit, please check the Unit's Installation & User Manual or contact our technical support team at 270-366-0457 for further assistance.

14. Technical indication and requirement

EMC and EMI comply with the CE certification requirements.

15.Queries and Settings



When the air conditioning unit is switch machine, Long press "COPY" for 3 seconds , first display P:00, if connected to an indoor unit, display P:00, if connected to multiple indoor units, press "∨" or "∧" to display P:01, P:02, and then press "Confirm" to enter the query indoor unit Tn(T1~T4) temperature and fan fault(CF), press "∨" or "∧" to select.



Not operating keys 15 seconds or press "Back" or press "ON/OFF" drop out of query temperature.



When the air conditioning unit is off, into the query function of temperature, press "∨" or "∧" to select SP, press "Confirm" to adjust the static pressure value.



When the air conditioning unit is off, into the query function of temperature, press "∨" or "∧" to select AF, press "Confirm" into test mode, press "Back" or press "ON/OFF" or press "Confirm" drop out of test mode. In AF mode, 3~6 minutes test completion automatically exits, if the test process, press "Back" or press "ON/OFF" or press "Confirm" , the test exits will be interrupted.

15.Queries and settings

Follow me function temperature compensation



LF

When the air conditioning unit is off, into the query function of temperature, press“∨”or“∧”to select tF. The compensation temperature Range : -5°C~5°C. Press “Confirm” into setting state, press“∨”or“∧” to select the temperature, then press “Confirm” to complete it.

LF : compensation temperature



TYPE

When the air conditioning unit is off, into the query function of temperature, press“∨”or“∧”to select type. Press “Confirm” into setting state, press“∨”or“∧”to select the type, then press “Confirm” to complete it.

CH:     
AUTO COOL DRY HEAT FAN

CC:   
COOL DRY FAN

HH:  
HEAT FAN

NA:    
COOL DRY HEAT FAN

15.Queries and settings

Set the highest and lowest temperature values



When the air conditioning unit is off, into the query function of temperature, press "∨" or "∧" to select tHI or tLo. Press "Confirm" into setting state, press "∨" or "∧" to select the temperature, then press "Confirm" to complete it.

The highest setting temperature range : 25°C~30°C
The lowest setting temperature range: 17°C ~24°C.

tHI : Highest value setting function.

tLO : Minimum value setting function.

Remote control function selection of wire controller



When the air conditioning unit is off, into the query function of temperature, press "∨" or "∧" to select rEC. ON or OF will be displayed in the temperature area to indicate whether it is valid or invalid.

When the selection is invalid, the wire controller does not process any remote control signals. Press "Confirm" into setting state, press "∨" or "∧" to select , then press "Confirm" to complete it.

15.Queries and settings

Two - line controller address selection



When the air conditioning unit is off, into the query function of temperature, press "∨" or "∧" to select



Adr, the temperature zone will display -- or A, B. Where -- refers to the code setting of the wire controller.

Adr

Press "Confirm" into setting state, press "∨" or "∧" to select , then press "Confirm" to complete it.

-- : The code setting  of the wire controller shall prevail.

Adr : The wire controller address setting.

Restore factory Settings

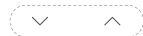

When the air conditioning unit is off, into the query function of temperature, press "∨" or "∧" to select



INIt, the temperature zone displayed --.

INIt

Press "Confirm" into setting state, press "∨" or "∧" to select to "ON" , then press "Confirm" to complete it.

INIt : Restore factory Settings .

15.Queries and settings

After the wire controller resumes the factory parameter setting, the following occurs:

- The rotating parameter setting is restored to 10 hours (the highest and lowest temperature are not set).
- The compensation of body temperature is uncompensated.
- COOL and HEAT/single COOL mode is restored to COOL and HEAT model.
- The temperature range was restored to 60~86°F (16-30°C) / 62~86°F (17~30°C).
- Remote receiving function is restored.
- The address of the two-control first-line controller is restored to the code switch.



MRCOOL®

COMFORT MADE SIMPLE

The design and specifications are subject to change without prior notice for product improvement.

Visit www.mrcool.com for the latest documentation.