



WWW.KUCHT.COM

BE A **PRO** IN YOUR KITCHEN



K6502D - DISHWASHER



BUILT-IN

DISHWASHER

SERVICE MANUAL

APPLICABLE MODEL: K6502D



IMPORTANT SAFETY NOTICE

The information in this service guide is intended for use by individuals possessing adequate backgrounds of electrical, electronic, and mechanical experience. Any attempt to repair a major appliance may result in personal injury and property damage. The manufacturer or seller cannot be responsible for the interpretation of this information, nor can it assume any liability in connection with its use.

WARNING

To avoid personal injury, disconnect power before servicing this product. If electrical power is required for diagnosis or test purposes, disconnect the power immediately after performing the necessary checks.

RECONNECT ALL GROUNDING DEVICES

If grounding wires, screws, straps, clips, nuts, or washers used to complete a path to ground are removed for service, they must be returned to their original position and properly fastened.

Table of Contents

Control Features	4
Component Location Views	7
Control Board Connector Locator View.....	7
Dishwasher Components	11
Outer Door Panel.....	11
Control Panel.....	11
Control Assembly.....	11
Door Switch Assembly.....	11
Detergent/Rinse Module.....	13
Inner Door Panel	14
Bottom Door Seal	14
Tub Gasket and Trim.....	15
Air Breaker Assembly	15
Turbo Drying System	16
Duct Nozzle	17
Top Light	18
PCB	18
Water Inlet Valve	19
Pressure Switch	20
Drain Pump Assembly	21
Thermistor	22
Turbidity Sensor	22
Diverter Valve Assembly	23

Table of Contents

Heating Element 24

Motor Pump Assembly 25

Sump Assembly 26

Troubleshooting 28

 chematics and Wiring Diagrams..... 29

Schematics and Wiring Diagrams..... 30

Control Features

Control panel



Wash Cycle Selections

1 Pots & PANS

This cycle is for hard-to-clean, heavily soiled dishes, pots, pans and dishes.

2 Normal wash

This cycle is for regularly soiled dinner dishes or silverware.

3 China crystal

This cycle is for lightly soiled china and crystal.

4 Quick wash

This cycle is for lightly soiled and pre-rinsed dishes and silverware.

5 Rinse only

This cycle is for pre-rinsing dishes or glasses. This is only a rinse that keeps food from drying on your dishes and reduces odor buildup in your dishwasher until you are ready to wash a full load. Do not use detergent.

6 ENERGY SAVER

For light soiled or pre-rinsed dishes and silverware.

Functions

7 Air exchange

Select the "Air exchange function, the dishwasher will exchange the air every 6 hours to keep the air in the dishwasher fresh.

8 Steam wash

For use with heavily soiled items, this STEAM option adds 30 minutes to the cycle time. The option is available with the cycles of "POTS & PANS" and "Normal wash".

9 Child lock

You can lock all controls to prevent children from accidentally changing the dishwasher cycle or starting the dishwasher.

Press the "Steam wash" and the "Vortex wash" simultaneously to select or cancel the function.

After the function is selected and the corresponding indicator light will turn on.

10 Vortex wash

Use this option when you want to wash pots and pans, durable serving bowls, and other large, very dirty, hard to clean dishes.

Use Vortex wash, place the dishes face down in the lower rack directly above the vortex wash arm in the back left corner.

11 Heated Dry

When the "Heated Dry" function is selected, the heater will work during the drying process.

12 Sanitize

To sanitize your dishes and glassware, select the Sanitize option. When the "Sanitize" function is selected, the temperature of water will be maintained at 70 °C (158°F) max.

Note: It is possible that 70 °C (158°F) may not be reached, if the temperature of the incoming hot water does not reach the suggested temperature.

13 Hi Temp Wash

When the "Hi Temp wash" function is selected, the temperature of water will be maintained at 60 °C (140°F) max.

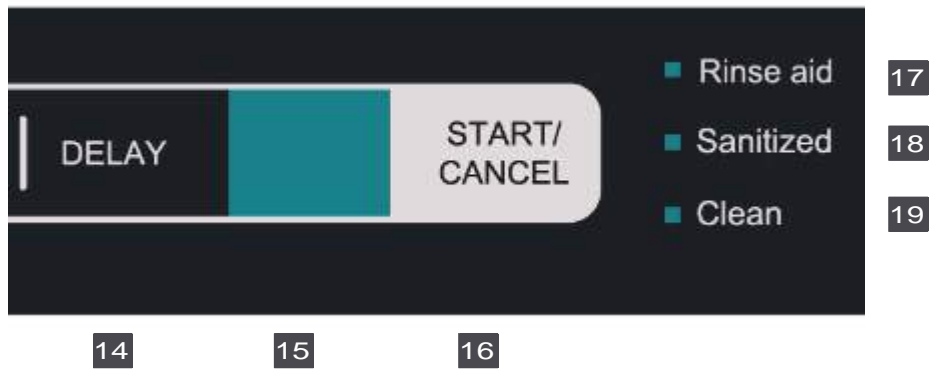

16 Start/Cancel

Push door firmly closed. The door latches automatically. Select the wash cycle and options desired, the indicator light above the pad will turn on. To start press the Start/Cancel key once, the light will glitter and the wash action begins. To cancel when a cycle is running, press Start/Cancel pad once and the dishwasher will start a 60 second drain and then shut off. At the end of the drain, you can select the desired cycle.

When you want to load more dishes or pause the dishwasher while it is already running, make sure to open the door slowly and carefully as there is a possibility of injury from the hot steam inside the dishwasher. You can add more dishes before the main wash starts. Open the door and check the detergent dispenser. If the main wash section of the detergent dispenser is still closed, you can add items. If the door is opened while the dishwasher is running, a safety mechanism is activated and stops the cycle.

14 Delay

To delay the start of a selected cycle, press Delay Start pad until the desired delay time shows in the LED display screen, it allows you to automatically start your dishwasher for 1 to 24 hours delay. To cancel the Delay Start option and begin the cycle, before the delay period is over press the Start/Cancel pad.

15 Display window

To display the remained hours and minutes of the running cycle, delay hours and error codes etc.

17 Rinse aid indicator light

Turns on when the dishwasher needs to add Rinse aid.

18 Sanitized indicator light

If a cycle with the sanitize function is finished, the sanitized indicator light turns on. If you open the door, it will turn off after 30 seconds.

18 Clean indicator light

Turns on after a cycle finished. If you open the door, it will turn off after 30 seconds.

Cycle progress indicator

Located on the right side of the front of the dishwasher, these lights indicate how far along is the current wash cycle while the dishwasher is running.

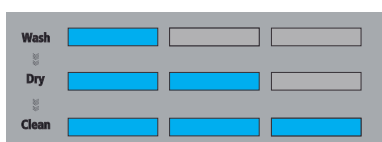

1	WASH	When the dishwasher is in a wash or rinse portion of a cycle, the Wash lights are illuminated.
2	DRY	When the dishwasher is in a drying portion of a cycle, the Wash and Dry lights are illuminated.
3	CLEAN	After the dishwasher has completed all portions of a cycle, all indicator lights are illuminated. If you open the door when the Cleaning lights are illuminated, all the portion lights will turn off after 30 seconds.

Status Window

01-24

If the Delay Start option is selected, the number of delay start hours shows in the Status Window. If the dishwasher is working and the wash cycle time is more than a hour, number of hours and minutes left shows alternately in the Status Window.

CL

Flashes once the program has been entered and the Start/Cancel key is pressed. It also flashes if the door is opened during a wash cycle. Close the dishwasher door to begin or continue a wash cycle.

MINUTES

Number of minutes left in a cycle (0-59 or 1H-2H). It shows hours and minutes alternately.

NOTE

The time remaining could suddenly increase or drop several minutes. This means the Smart Sensor has checked the soil level and determined if additional water fills are needed or if water fills can be deleted.

Error indication

In certain situations which are critical to the machines function and safe operation, the control shall shut down and indicate an error code Er (See Error Codes on page 18).

If Er codes are displayed, contact the dealer or servicer. They will be able to provide assistance in trouble shooting the problem and or locate an authorized service technician if needed.

Cycle Chart

Program	Description of Cycle	Water (gal)	Cycle time (min)
POTS & PANS	Pre Wash	6,02	140
	Pre Wash		
	Wash(48°C) 118 °F		
	Rinse		
	Rinse		
	Rinse(58°C) 136 °F		
NORMAL WASH	Drying	2,85-6,07	105~135
	Pre Wash		
	Auto(42~48°C) 107-118 °F		
	Rinse(50~58°C) 122-136 °F		
CHINA CRYSTAL	Drying	5,09	120
	Pre Wash		
	Pre Wash		
	Wash(48°C) 118 °F		
	Rinse		
	Rinse(58°C) 136 °F		
QUICK WASH	Drying	4,09	60
	Pre Wash		
	Wash(40°C) 104 °F		
	Rinse(50°C) 122 °F		
RINSE ONLY	Rinse Only	2,11	20
ENERGY SAVER	Drying	5,09	105
	Rinse(50°C) 122 °F		
	Rinse		
	Wash(40°C) 104 °F		
	Pre Wash		
	Pre Wash		

Component Location Views

Front View



Control Panel View

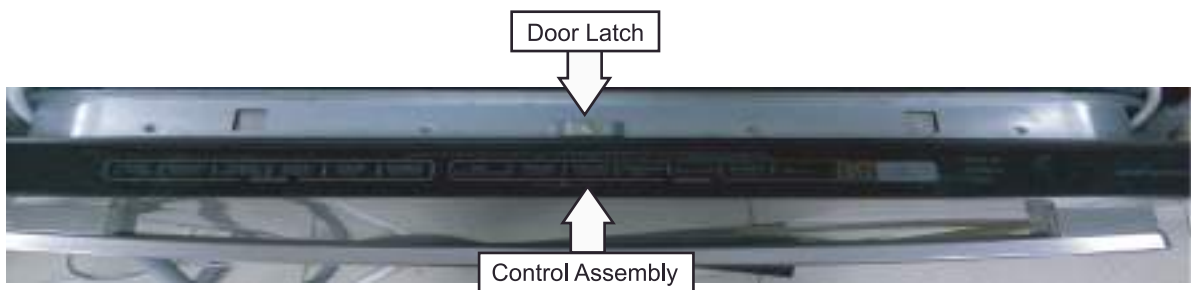

Interior View

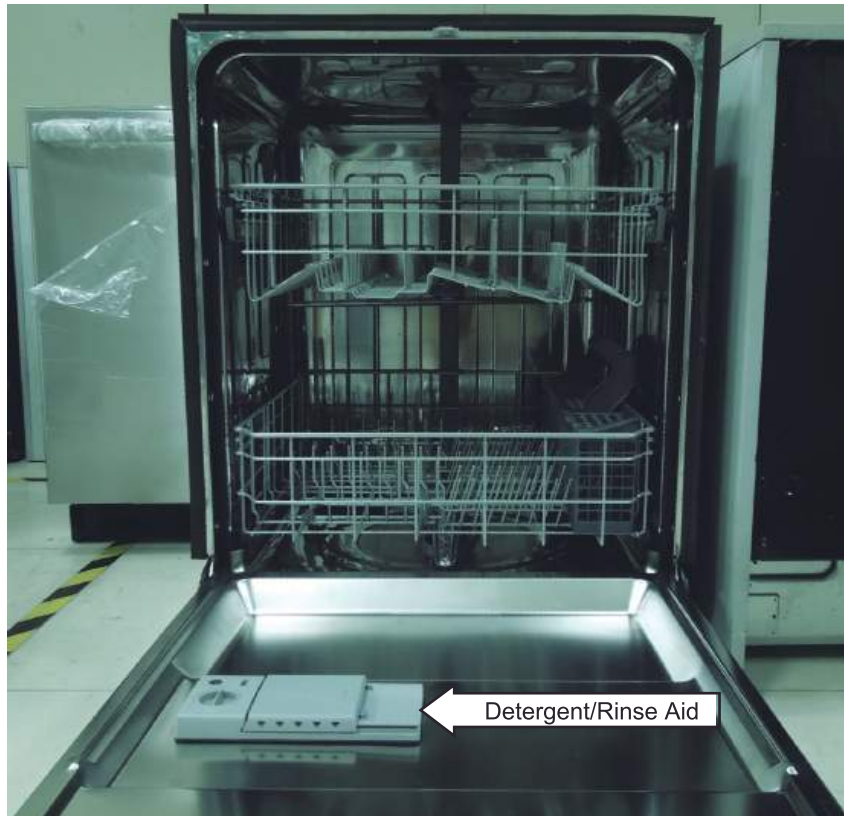

Detergent/Rinse Aid Compartment View



Interior View of Basin

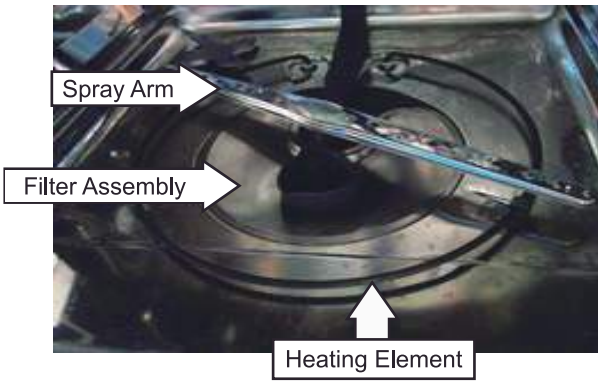

Light Side View

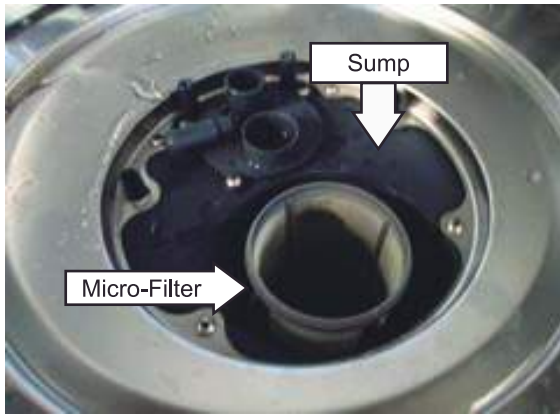
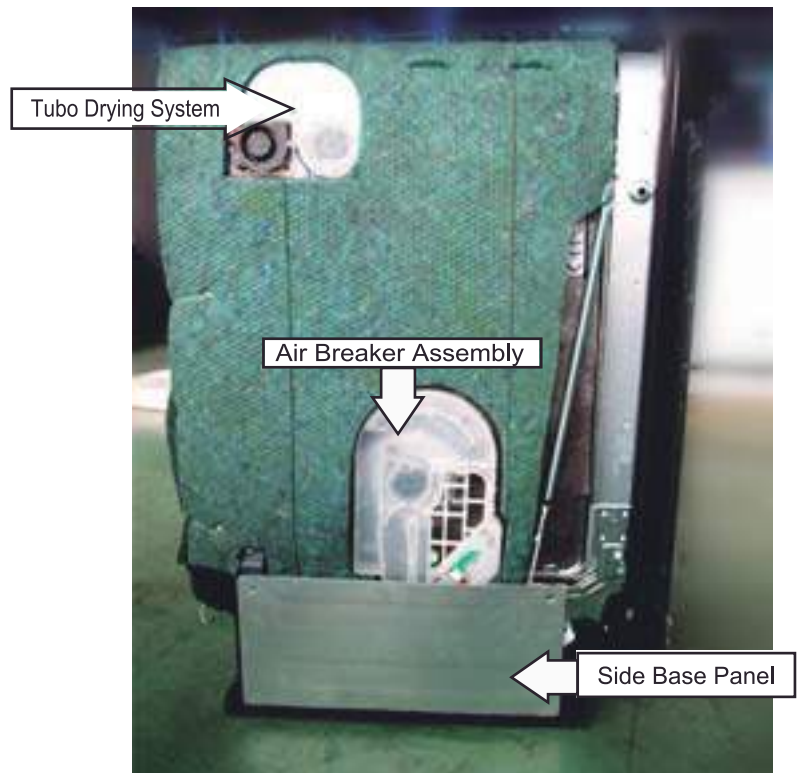

Bottom View

Note: Drain hose is shown in shipping configuration.

Front

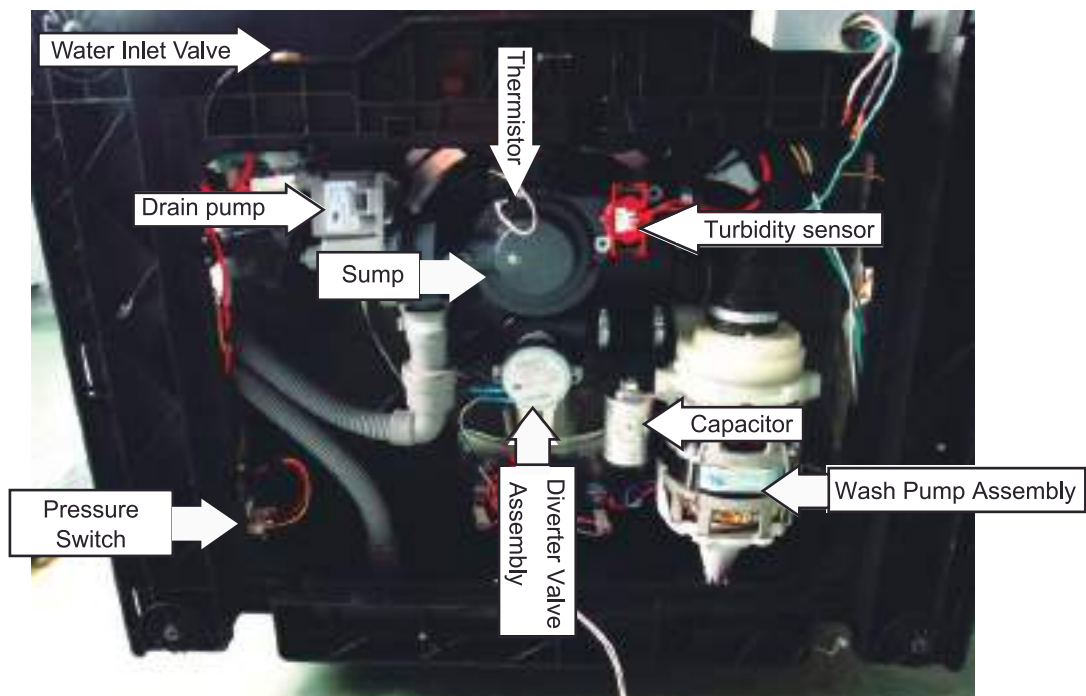

Back

Pin 2 = wash pump;

Control Board Connector Locator View

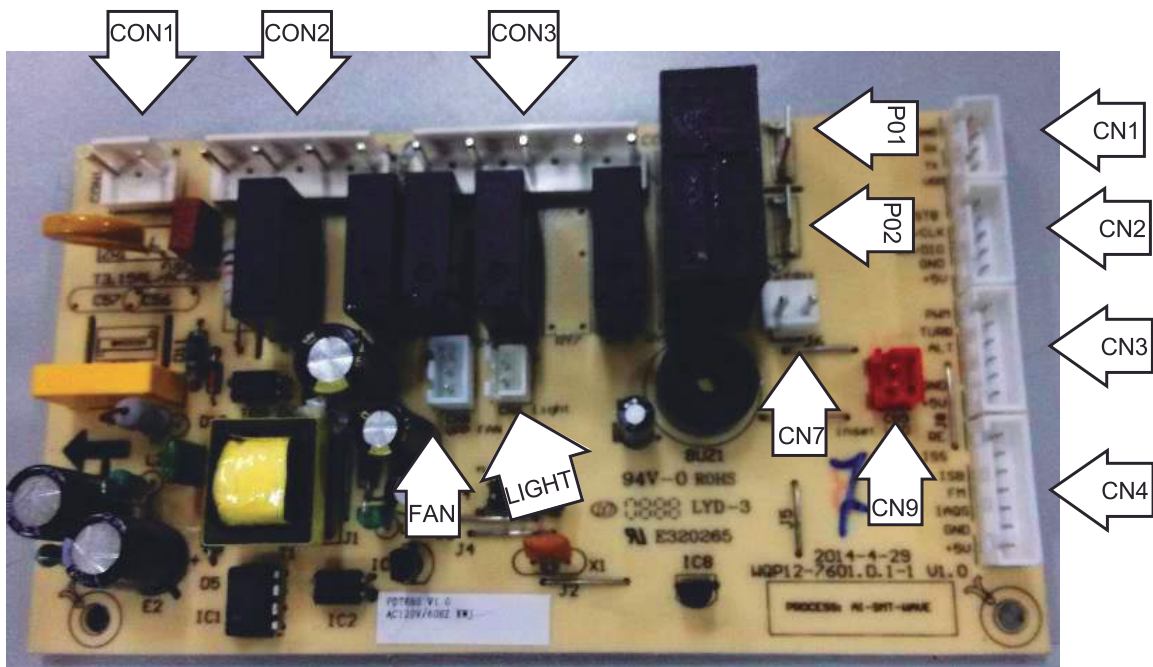

CON1 L-N

CON2 120 VAC output:
Pin 1 = door switch;
Pin 2 = wash pump;
Pin 3 = not used;
Pin 4 = storm wash pump;

CON3 120VAC output:
Pin 1 = water inlet ;
Pin 2 = L (for water inlet);
Pin 3 = dispenser;
Pin 4 = not used ;
Pin 5 = drain pump ;

P01 P02 Heater;

CN1 Not used;

CN2 Connected to display board;

CN3 Turbidity and diverter valve detection;

CN4 Rinse aid/ flow metre/ water flood ditective connection;

CN7 Not used;

CN9 Not used;

Dishwasher Components

Outer Door Panel

The outer door panel covers the door to the dishwasher and must be removed to access the control panel, detergent/rinse module, bottom door seal.

To remove the outer door panel, remove 12 Phillips-head screws, and then lower the door panel from the control panel.

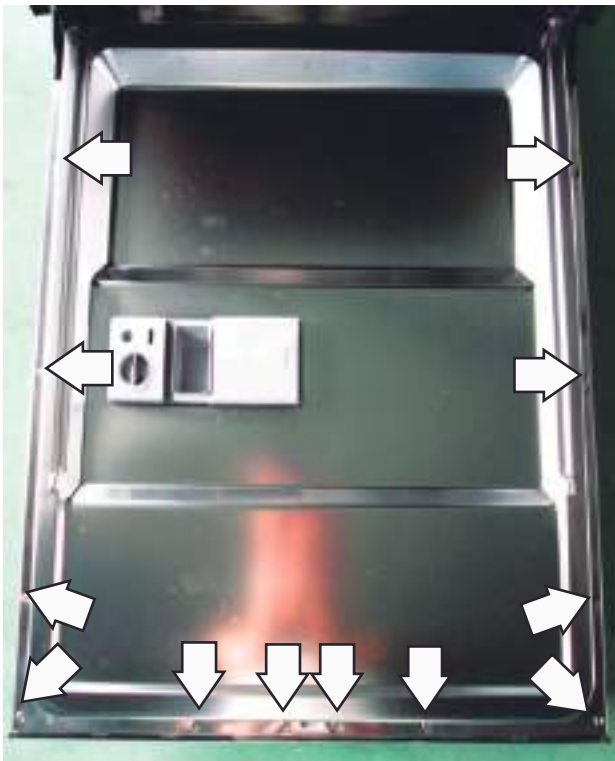

Control Panel

To remove the control panel:

1. Remove the outer door panel. (See *Outer Door Panel*.)
2. Remove 2 Phillips-head screws from door latch.



3. Tilt the control panel out to clear lip and remove.

Note: The escutcheon console cover or top trim with lettering is replaced using adhesive.

Control Assembly

The control assembly consists of PCB user interface board and Cycle Progress Indicator.

To remove the PCB user interface assembly:

1. Disconnect the power supply to the dishwasher.
2. Remove the control panel. (See *Control Panel*.)



4. Disconnect 1 wire harness from the cycle progress indicator.
5. Disconnect the cycle progress indicator.

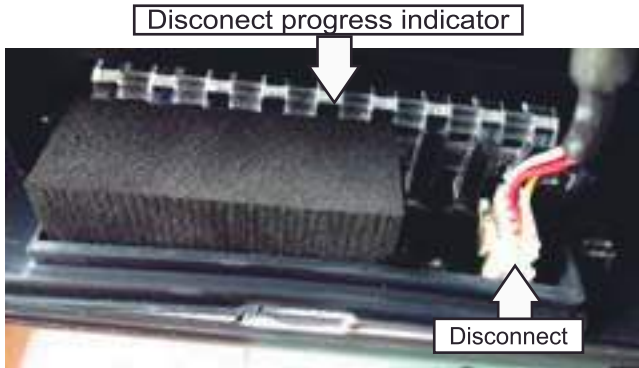

Note: The PCB user interface board is pasted to control panel, if want to change the PCB user interface board, you should disconnect the control panel assembly and change the new one.

Door Switch Assembly

The door switch assembly consists of 1 switch activated by a spring-loaded plunger. The door switch connects or disconnects the line (hot) side of 120 VAC.

WARNING: Power remains applied to the controller location at CN2, Pin 1, while the door is open (unlatched).

When the door is in the closed position, the door latch presses and holds down the switch plunger on the door switch assembly. This action holds the door firmly against the seal, and the normally open contacts of the door switches are closed.

To remove the door switch assembly:

1. Disconnect the power supply to the dishwasher.
2. Remove the control panel. (See **Control Panel**.)
3. Disconnect the 2 wiring harnesses from the door switch.

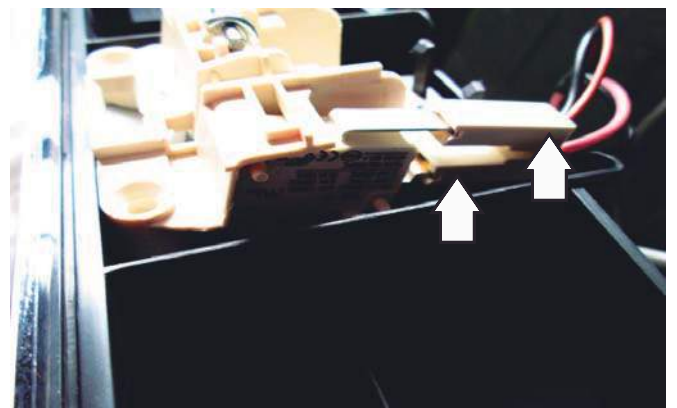
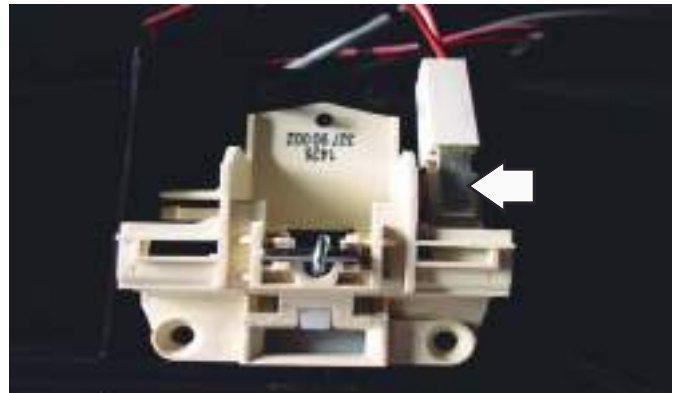

Detergent/Rinse Module

The control panel must be removed to access the detergent/rinse module. (See **Control Panel**.)

The detergent/rinse module is connected by 4 wires and held in place by snap joints.

The detergent/rinse module operates on 120 VAC

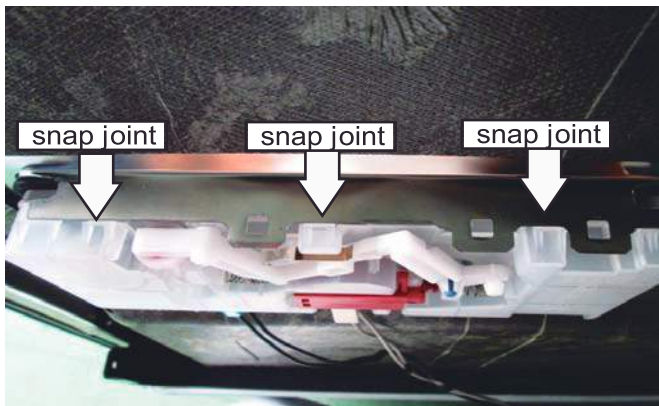
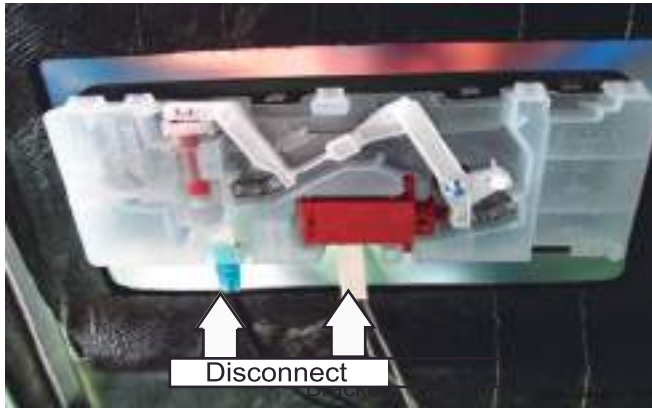

The detergent/rinse module automatically dispenses both the detergent and the rinse agent at the appropriate times. The module is activated twice during a wash cycle. Detergent is dispensed at the beginning of the main wash cycle and rinse agent at the beginning of the final rinse.

Operation of the detergent/rinse module can be checked by using the service test mode. (See **Service Test Mode**.)

The first time the module is activated, the lever slides up the upper path of the connecting rod (1). This action releases the detergent cover.



When deactivated, the lever returns down the lower path and comes to rest under the notch (2) in the center of the connecting rod.

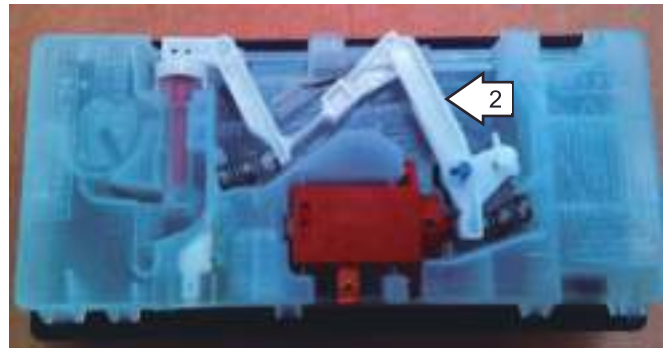

At the second activation, the lever lifts the connecting rod by the notch. This action lifts the rinse dispenser plunger (3) and releases the rinse agent. When deactivated, the lever returns to its original starting position.



Note: Make sure the rubber seal is retained in the recessed groove before reinstalling the module to the door assembly.

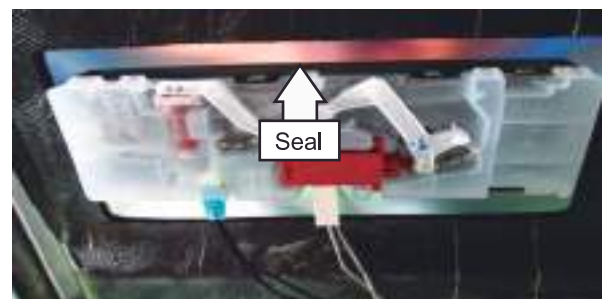

Inner Door Panel

To remove the inner door panel:

1. Disconnect power.
2. Remove the control panel. (See *Control Panel*.)
3. Remove the detergent/rinse module. (See *Detergent/Rinse Module*.)
4. Remove the 2 Phillips-head screws from the hinge plate .



5. Remove the 2 Phillips-head screws from the Base side panel on each side.



6. Disconnect door spring and door cable .

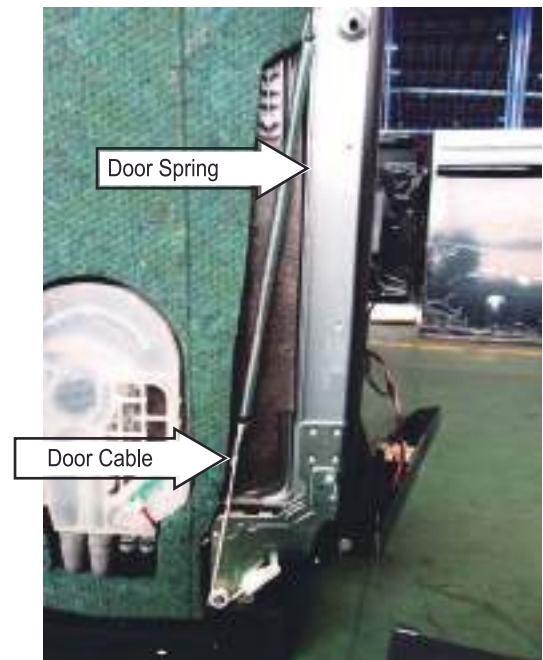

7. Open the inner door at 10°, and lift the door until the door hinge separate from the type D pin.

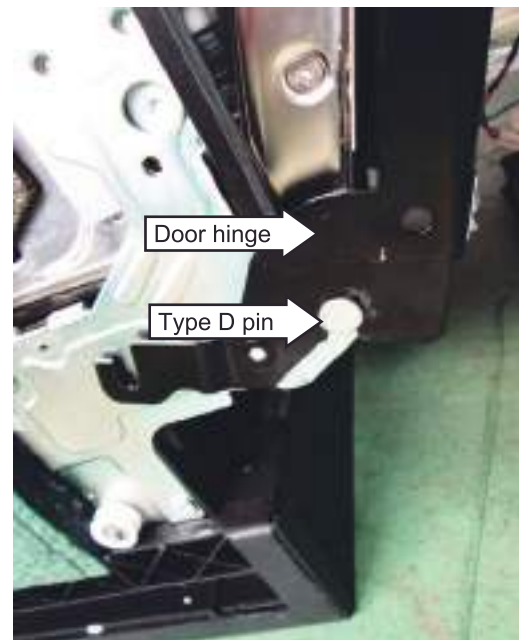

Door Bottom Seal

The door bottom seal prevents water leakage by sealing between the bottom of the door and the tub. It is not replaced as a separate part on this dishwasher. It is replaced as part of the inner door panel. (See *Inner Door Panel*.)

Tub Gasket and Trim

The dishwasher tub seal prevents water leakage. The seal is fitted in a seal channel that lines the rim of the dishwasher tub.

To remove the tub seal or trim:

1. Open the dishwasher door.
2. Remove the dishwasher tub seal by grasping one end of the seal to peel it away from the seal channel.



3. Remove the dishwasher trim by pulling the trim straight off the lip of the tub.

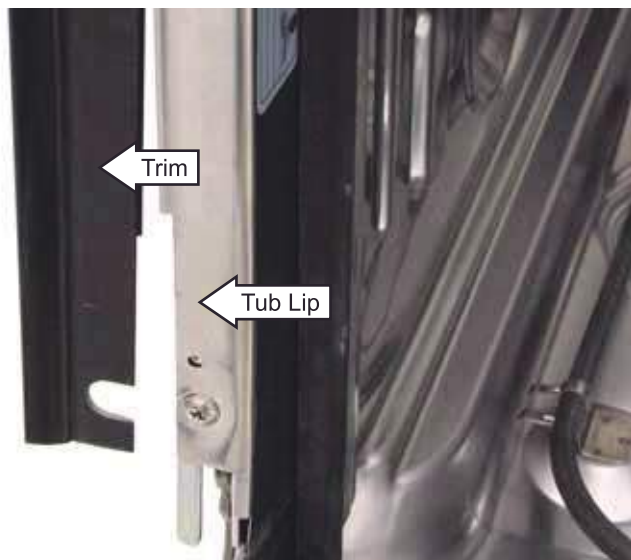

4. Reverse the above procedures to install.

Note: When installing the tub seal, make sure it is seated properly in the seal channel. Run your finger over the seal to make sure it is smooth and even for a proper seal. A correctly installed gasket will have both ends of the gasket equally distant from the bottom of the tub.

Air breaker assembly

The Air breaker assembly is mounted on the left side of the tub. Its purpose is to provide a method of supplying water for the wash and rinse cycles. The air gap prevents the siphoning of wash water from flowing back into the water supply system, should the water pressure drop to less than atmospheric pressure. The Air breaker assembly also allows air into the tub for drying dishware.

To remove the air breaker assembly:

1. Disconnect the power.
2. Remove the base side panel.
3. Disconnect 1 wire harness from the air breaker assembly.

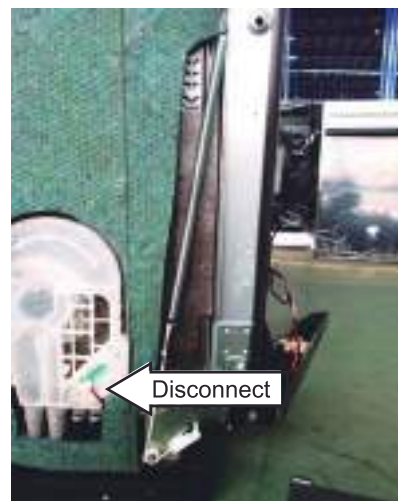

4. Open the door and rotate the Air breaker nut and remove it from the air breaker assembly.
5. Remove the 4 clamps from the pipes.

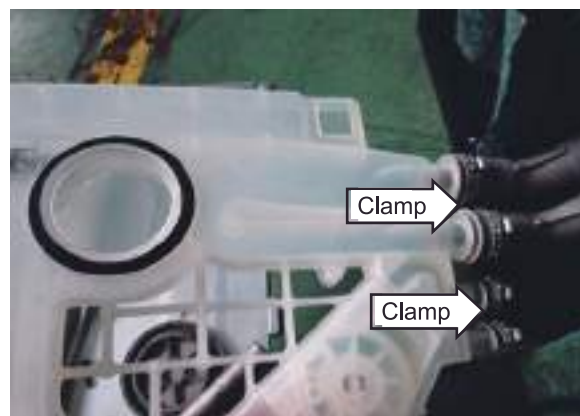

Turbo Dry System

The Turbo Dry System has 2 fans. One is on the left of the tub. Its purpose is to provide air from outside to the tub. The other one is on the right side of the tub. Its purpose is to discharge hot air from tub to the outside. 2 fans work together to supply the airflow for drying dishware.

To remove the left fan:

1. Disconnect the power.
2. Remove the side base panel.
3. Disconnect 1 wire harness from the left fan.

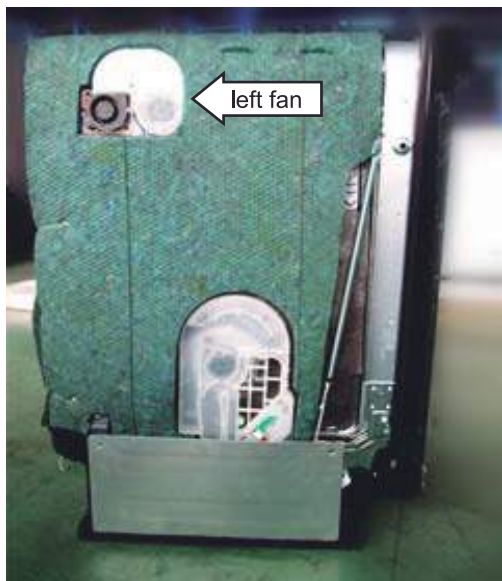

4. Open the door and rotate the fan nut and remove it from the left fan.



5. The left fan is using 2 snap joints to fasten, release snap joints and take the DC fan motor out.

To remove the right fan:

1. Disconnect the power.
2. Remove the side base panel.



3. Open the door and rotate the fan nut and remove it from the left fan.
4. Remove the condenser in the direction shown in the figure.

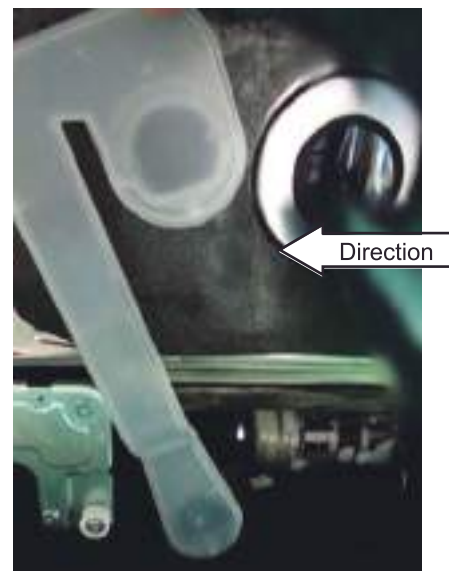

5. Disconnect 1 wire harness from the right fan.

- Lay the dishwasher on its back.
- The right DC fan is using 2 snap joints to be fasten to the base. Remove it in the direction shown in the figure.

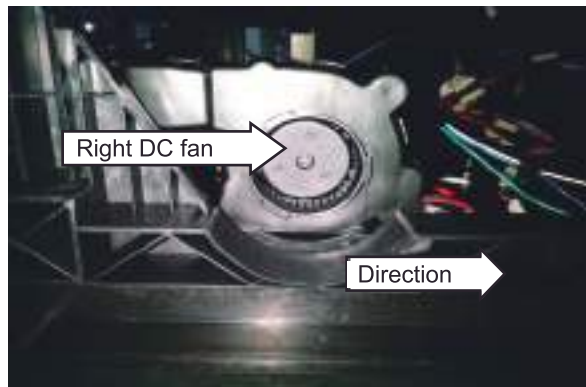
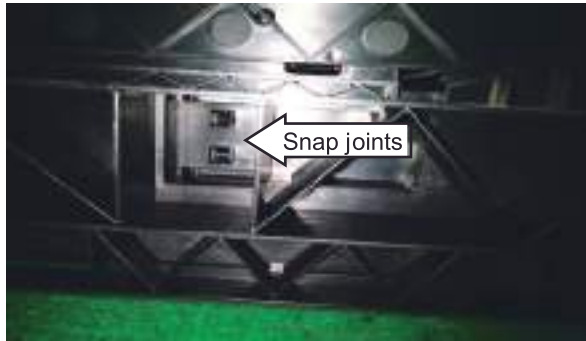

- Release the snap joints and take the right DC fan motor out.

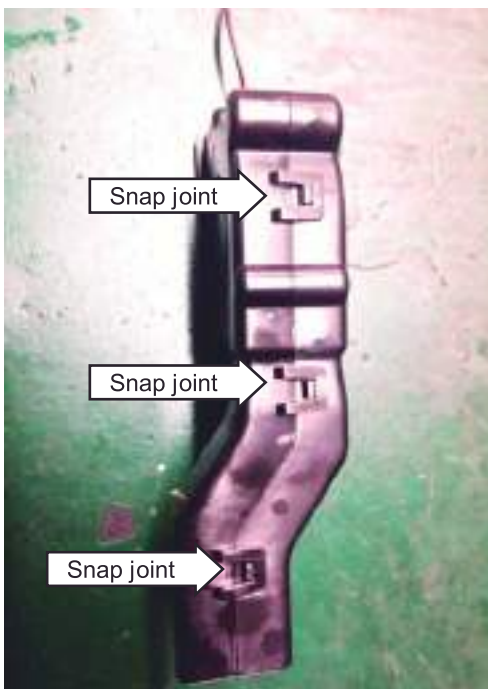

Nozzle Duct

To remove the nozzle duct :

- Disconnect power.
- Open the door, and remove the 2 Phillips-head screws on the Lower spray seat.



- Release the snap joints shown in the figure. Then take out the nozzle duct and lower spray seat.

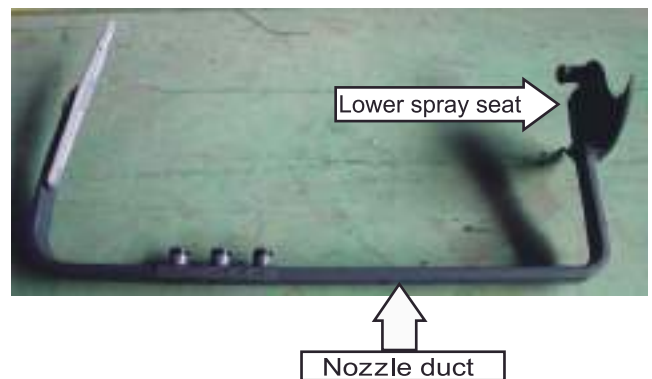

Top Light

To remove the Top Light:

1. Disconnect power.
2. Remove the insulation.
3. Disconnect the 1 harness from the Top light.
4. Remove the top light.

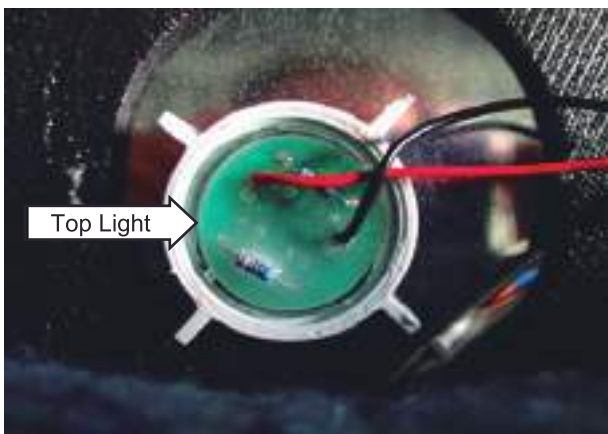
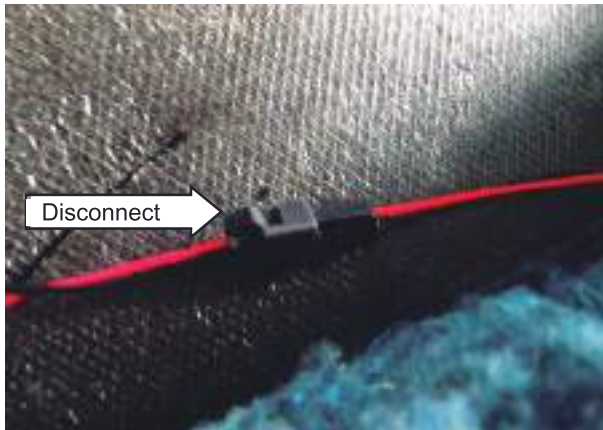

4. Remove 2 Phillips-head screws on the kick board.

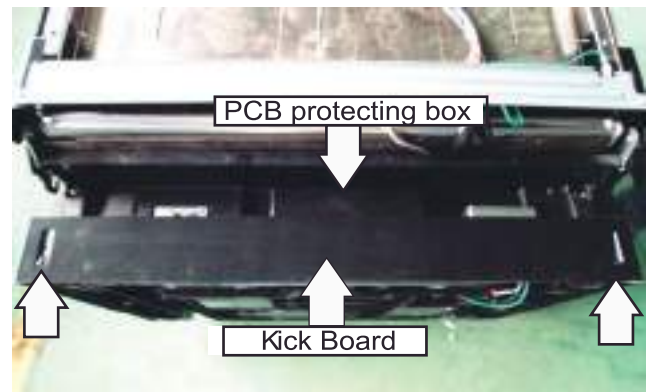

5. Remove 2 Phillips-head screws on the PCB protecting box.

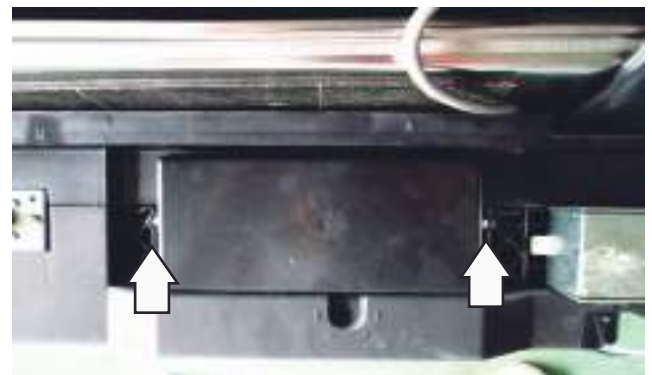

6. Remove 2 Phillips-head screws that attach PCB to the PCB board.

7. Disconnect the wire harnesses from the PCB

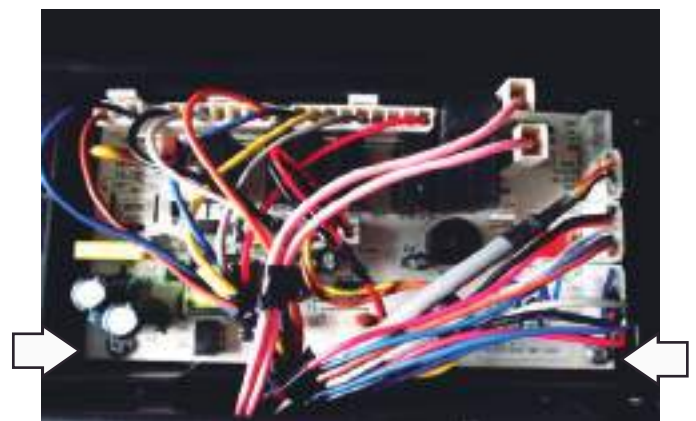

PCB

Printed Circuit Board is the center of the dishwasher, which receive and process the signal from components, send order to components and deal with the feedback information, etc.

To remove the PCB Power Board:

The PCB can be removed from the protecting box at the bottom of the machine.

1. Disconnect the power.
2. Take out cutlery basket, basket and filter system
3. Lay the dishwasher on its back.

Water Inlet Valve

The water inlet valve is electronically controlled and solenoid-operated. The water valve has an approximate resistance value of 1 K Ω .

The water valve is mounted on a bracket located on the left side of the front brace.

To remove the water valve:

1. Disconnect power.

2. Remove the 2 Phillips-head screws on the kick board.

3. Remove the 2 Phillips-head screws on the lower front cover.

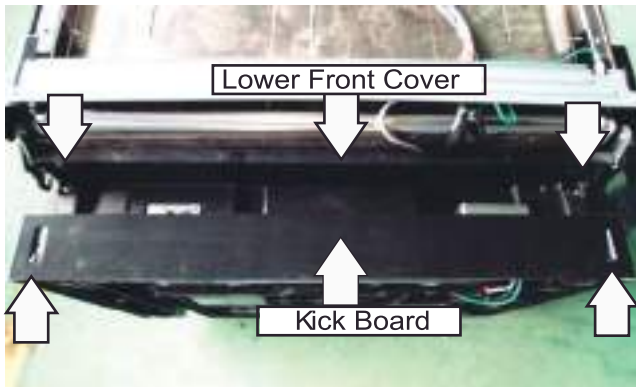

4. Disconnect the water supply line from the valve inlet.

5. Remove the 2 Phillips-head screws that hold the bracket to the front brace.

6. Disconnect the 2 wires from the solenoid.

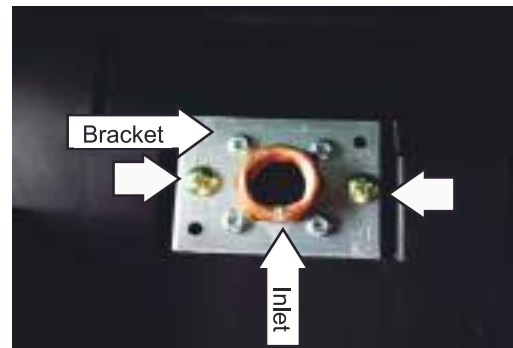

7. Remove the clamp and the outlet hose from the valve.

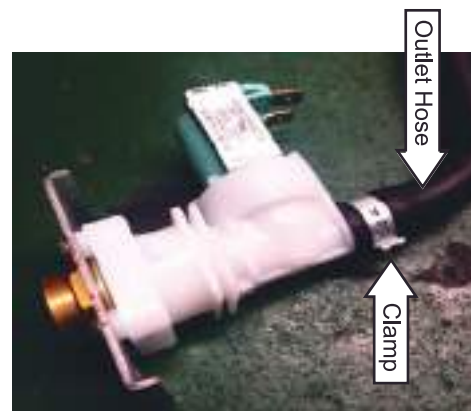

Caution: The clamp is easily damaged during removal and should not be reused. Use the screw-type hose clamp provided with the new valve.

Pressure Switch

The pressure switch is an overflow safety device mounted on the base located on the left rear. A clear plastic tube (the pressure switch hose) runs from the pressure switch, around the air breaker assembly, and to the sump.

As the dishwasher basin fills with water, the air pressure in the pressure switch hose increases. Normally, the electronic control regulates the amount of time the water fill valve remains open. If the water fill valve remains energized, the overfilling of the basin increases the air pressure in the pressure switch hose causing the pressure switch to open the circuit to the water valve and energize the drain pump.

To remove the pressure switch:

1. Disconnect power.
2. Lay the dishwasher on its back.
3. Remove the 1 Phillips-head screw that attach the base cover to the base.

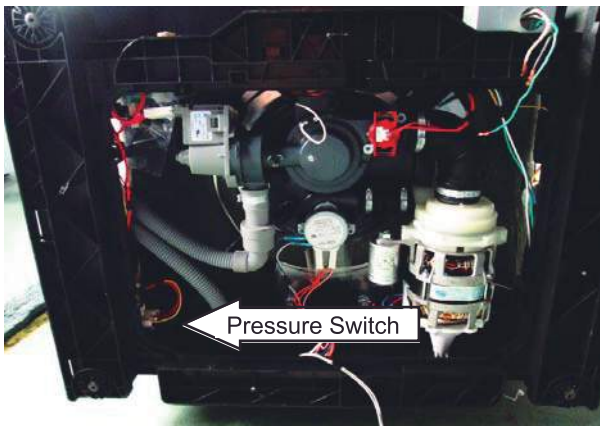

4. Release the snap joint that attach the pressure switch to the base, and take out the pressure switch.

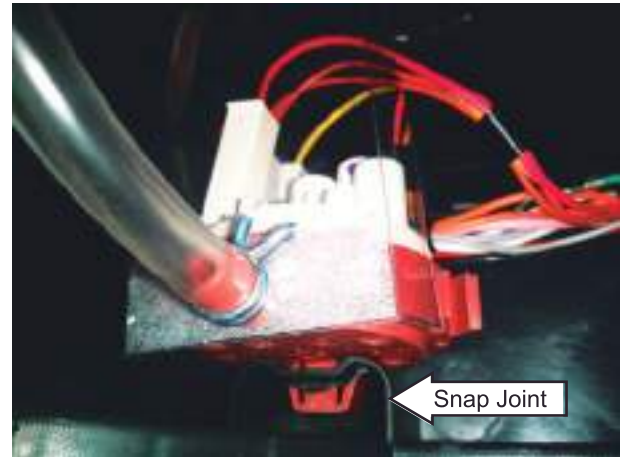

5. Disconnect the brown wire from terminal 1, the yellow wire from terminal 2, and the red wire from terminal 3.
6. Remove the pressure switch hose from the pressure switch.

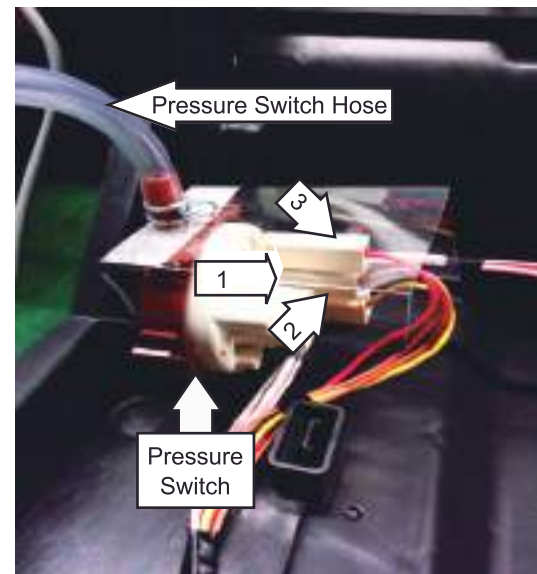

Note: When installing the pressure switch, ensure the switch is fully seated in the bottom of the base bracket.

Drain Pump Assembly

The drain pump assembly is located under the tub and operates on 120 VAC. It is energized for the first 60 seconds of a new cycle and 90 seconds after the wash pump shuts down to remove any water in the dishwasher sump. The drain pump forces water out of the drain line. A check valve flapper on the drain pump prevents the dirty water from reentering the sump.

The drain pump has an approximate resistance value of 25– 35 Ω .

To remove the drain pump:

1. Disconnect power.
2. Open the dishwasher door and remove the bottom rack.
3. Remove the dishwasher from its installation.
4. Lay the dishwasher on its back.
5. Remove the 1 Phillips-head screw that attach base cover to the base.

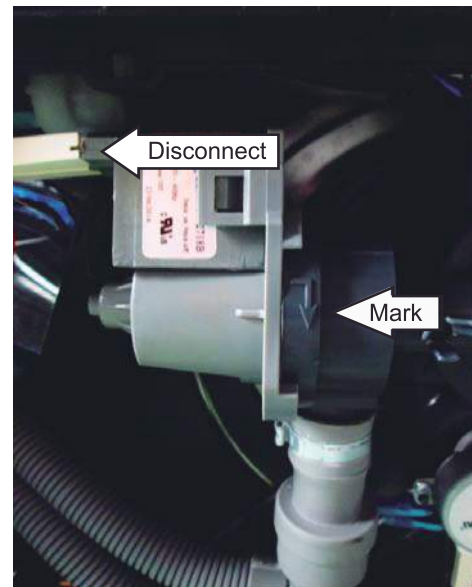
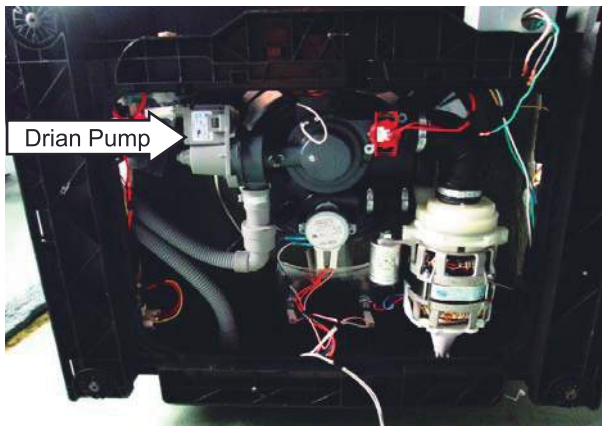

Note: Ensure the O-ring is retained in the pump seal before reassembly.



6. Rotate the drain pump 1/4-turn anticlockwise to remove, which the opposite direction of the mark on the sump.
7. Disconnect the 2 wires from the drain pump.

Thermistor

The thermistor is located under the tub and is attached to the back side of the sump with two Phillips-head screws (5mm hex-head).

During the hot wash cycle, the thermistor senses the water temperature and turns the heating element off .

Note: If the thermistor is not operating, the hot wash cycle will set a default time for the heating element to cycle.

The thermistor has a negative coefficient. As the temperature at the contact point on the tub increases, the thermistor's resistance decreases. The thermistor has an approximate resistance of $R@25^{\circ}\text{C}=10\text{K}\Omega\pm 2\%$; $R@60^{\circ}\text{C}=3011\Omega\pm 2\%$.

To remove the thermistor:

1. Disconnect power.
2. Lay the dishwasher on its back.
3. Remove the 1 Phillips-head screw that attach base cover to the base.
4. Disconnect the thermistor wire harness.
5. Using either an offset Phillips-head screwdriver or 5-mm box-end wrench, remove the two Phillips-head screws(5-mm hex-head) and the thermistor from the sump.

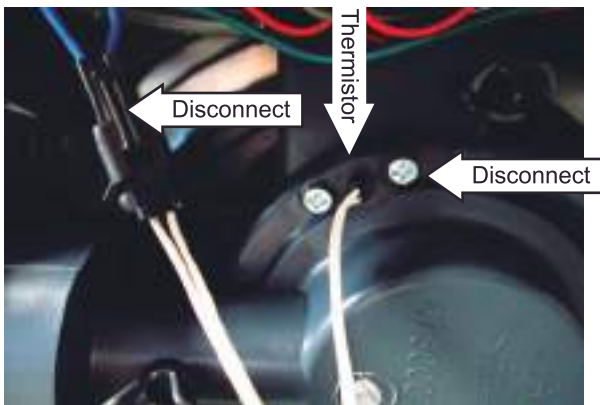

Note: Ensure the O-ring is retained in the thermistor before reassembly.

Turbidity Sensor

The turbidity sensor is located under the tub and is attached to the back side of the sump with two snap joints.

During the prewash of wash cycle, the turbidity sensor senses the water, judges the AD interval and chooses the appropriate wash cycle.

Note: If the turbidity sensor is not operating, wash dishwasher will choose a default wash cycle and inlet default wash water.

To remove the thermistor:

1. Disconnect power.
2. Lay the dishwasher on its back.
3. Remove the 1 Phillips-head screw that attach base cover to the base.
4. Disconnect the thermistor wire harness.
5. Release the snap joints to take the turbidity sensor out.

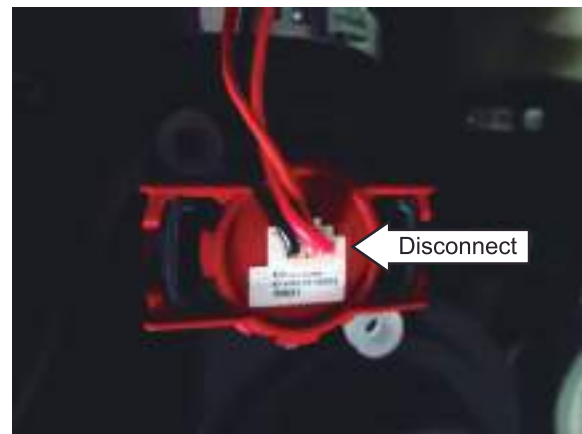

Note: Ensure the O-ring is retained in the turbidity sensor before reassembly.

Diverter Valve Assembly

The diverter valve assembly is located under the tub and operates on 120 VAC. Diverter, also named alternating flow control valve, is used to control the flow of water between the upper and lower spray arms and can also be used on some models to stop the flow of water to the upper spray arm on models equipped with a half load feature.

The diverter valve assembly include diverter motor, micro s/w, cam and seal ring.
The diverter valve assembly will auto detect the location at the first 60s of the wash cycle.

To remove the diverter valve assembly:

1. Disconnect power.
2. Open the dishwasher door and remove the bottom rack.
3. Lay the dishwasher on its back.
4. Disconnect the 2 wires from the diverter motor.
5. Remove the 2 Phillips-head screws that hold the diverter motor to the sump.

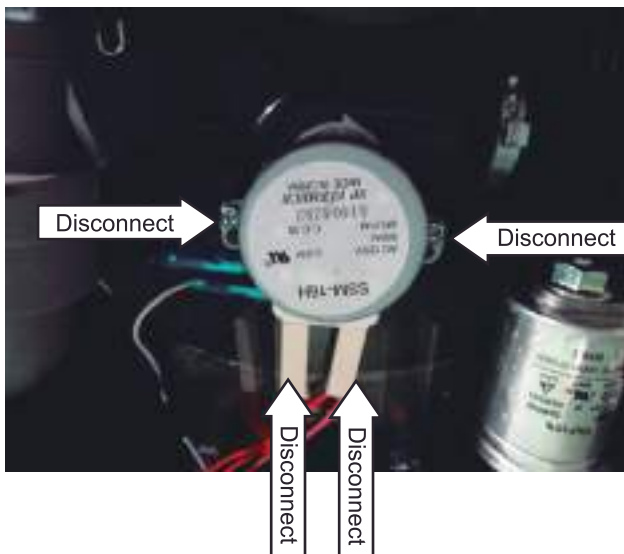

6. Remove the cam.

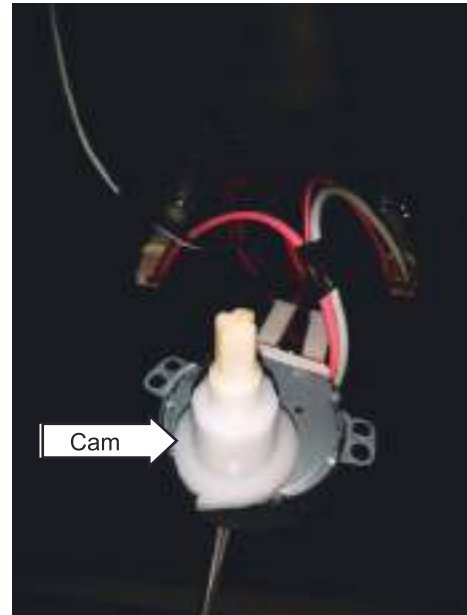

7. Disconnect the 2 wires from the micro s/w.

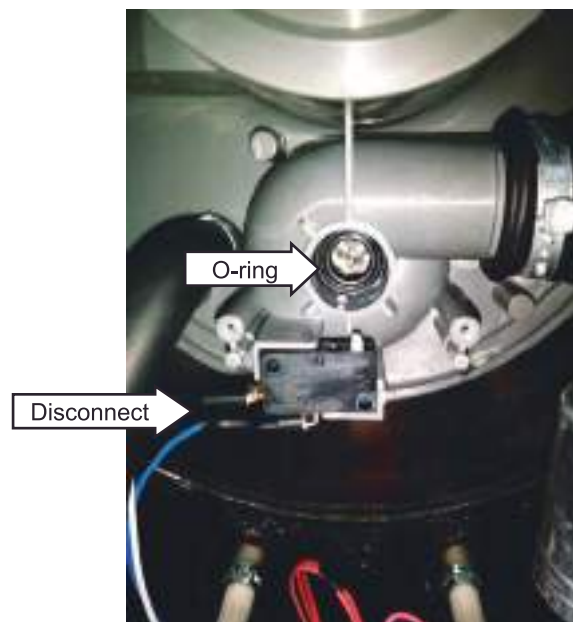

Note: Ensure the O-ring is retained in the sump before reassembly.

Heating Element

The heating element maintains water temperature during the wash and rinse cycles and heats the air during the drying cycle.

The heater has an approximate resistance value of 10-15 Ω

To remove the heating element:

1. Disconnect the power.
2. Open the dishwasher door and remove the bottom rack.
3. Lay the dishwasher on its back.
4. Remove the 1 Phillips-head screw that attach base cover to the base.

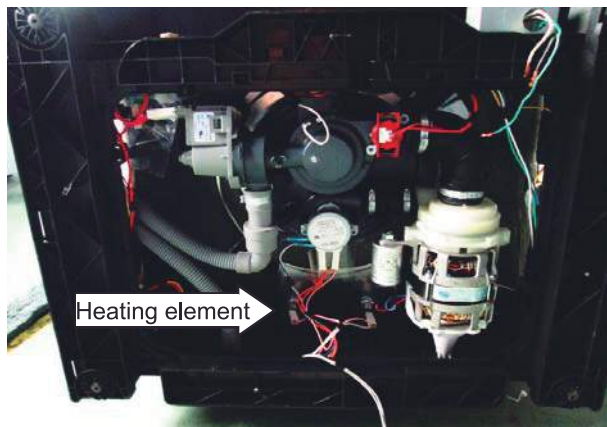

5. Locate the wires leading to the heating element terminals and pull down the 2 nylon terminal covers.
6. Disconnect the 2 wires from the heating element.

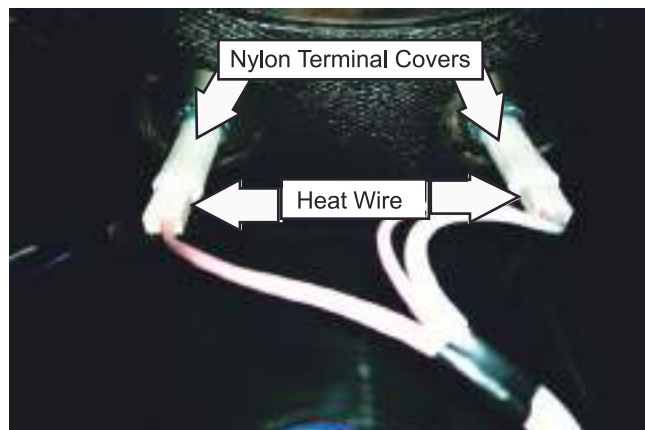

10. Remove the inner 8-mm nuts, washers, and that attach the heating element to the bottom of the tub.

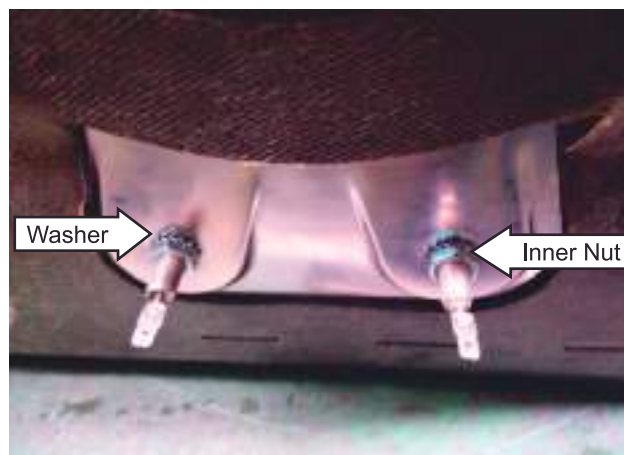

11. Lift the back side of the element and release it from the 2 retainers.



Motor Pump Assembly

The motor pump assembly is located under the tub on the right of the sump assembly. The motor utilizes a start capacitor rated at $10\mu\text{fd}$. The motor rotates clockwise (as viewed from the terminal end) and draws approximately 1 amp at 120 VAC.

The motor pump assembly has an approximate resistance of $R_1=24\text{-}30\Omega$, and $R_2=19\text{-}25\Omega$.

To remove the motor pump assembly:

1. Disconnect power.
2. Open the dishwasher door and remove the bottom rack.
3. Lay the dishwasher on its back.
4. Remove clamps and pump outlet hose.
5. Remove clamps and pump inlet hose.

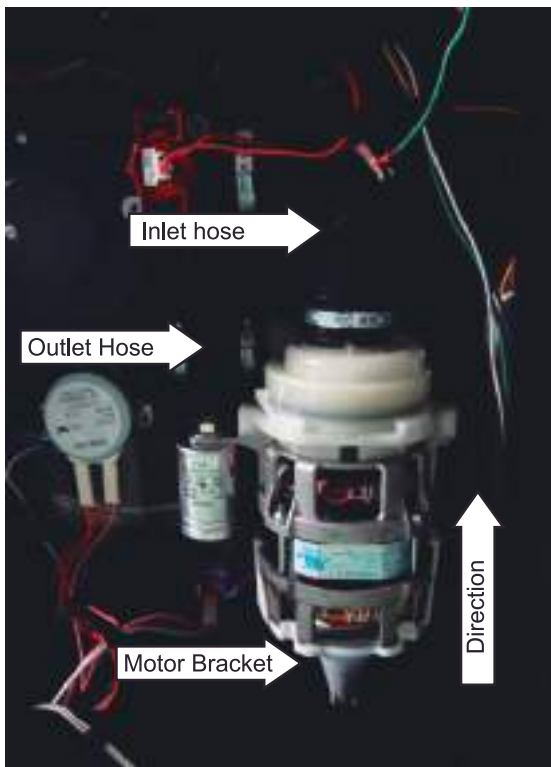

Note: Factory-installed hose clamps are not reusable. When installing a water inlet valve, drain pump assembly, motor pump assembly, or sump assembly, replace the old clamps with new screw-type hose clamps provided. The screw-type hose clamps are available separately.

6. Remove the motor pump from the base in the direction shown in the figure.
7. Disconnect the motor wire harness and the motor ground wire.

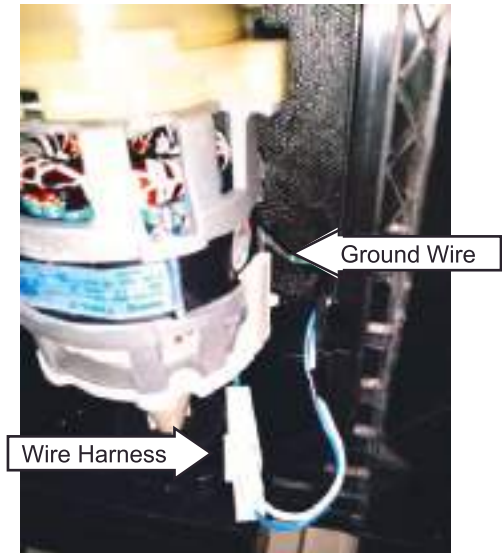

8. Pull the motor bracket off the motor tab.

To remove the motor pump capacitor:

1. Follow steps 1 through 7.
2. The capacitor is connected to the motor with 2 wires and held in place with a 13-mm nut. Disconnect the wires and the nut.

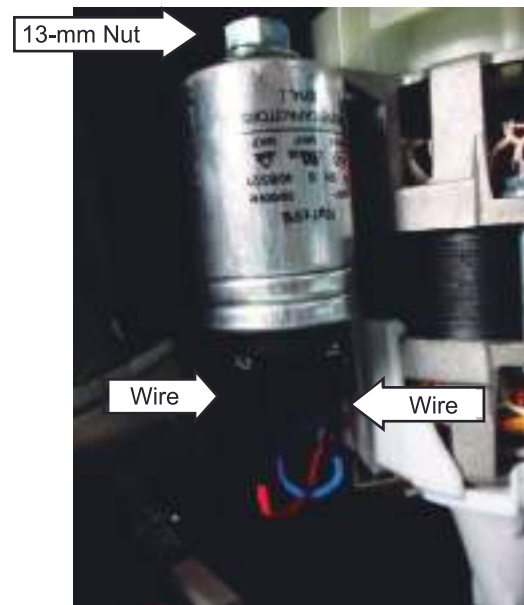

Sump Assembly

The sump assembly consists of the filter assembly, micro-filter, Diverter valve cover, storm wash connecting pipe, sump gasket and sump. The filter assembly prevents large particles from reaching the micro-filter and the micro-filter prevents small particles from reaching the sump. The filter assembly rests above the sump and the micro-filter sits above the sump basin. The Phillips-head screws hold the sump gasket and sump to the bottom of the dishwasher. The diverter valve cover and storm wash connecting pipe that hold to the sump by Phillips-head screws, control the direction of flow. The filter assembly, micro-filter, distributor valve cover and storm wash connecting pipe are accessed from inside the dishwasher. The gasket and sump are located under the tub.

To remove the sump assembly:

1. Disconnect power.
2. Open the dishwasher door and remove the bottom rack.
2. Rotate cylinder filter 1/4-turn in the direction shown on the cylindrical filter.
4. Lift steel filter out of tub.

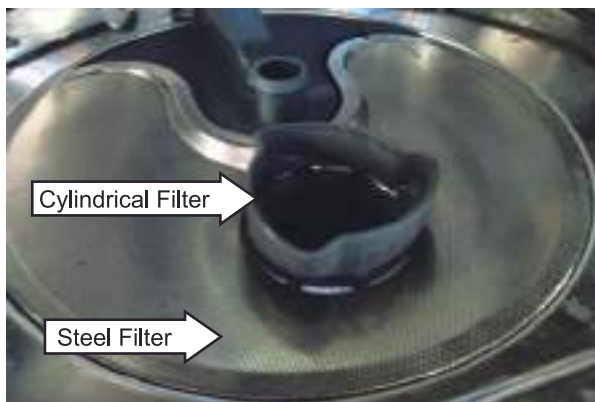

5. Remove 2 Phillips-head screws and take the lower spray seat out of the tub.
6. Lift the micro-filter out of the tub.

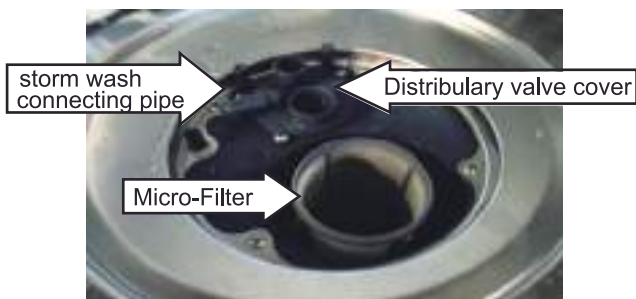

7. Remove the 3 Phillips-head screws and take the diverter valve cover and storm wash connecting pipe out of the tub.
8. Remove the 4 Phillips-head screws that attach the sump to the tub.



9. Remove the sump gasket (not shown) and sump.
10. Lay the dishwasher on its back.
11. Disconnect the thermistor wire harness and turbidity sensor wire harness.

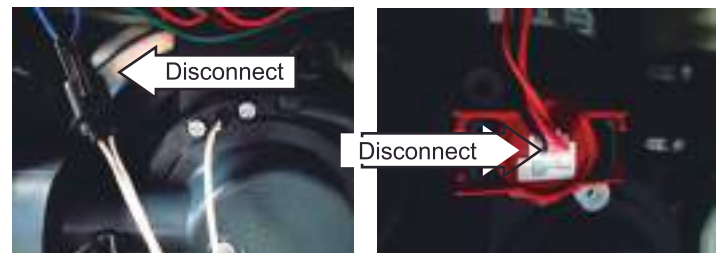

12. Remove the pressure switch hose from the sump air chamber cover that is in front of the sump.

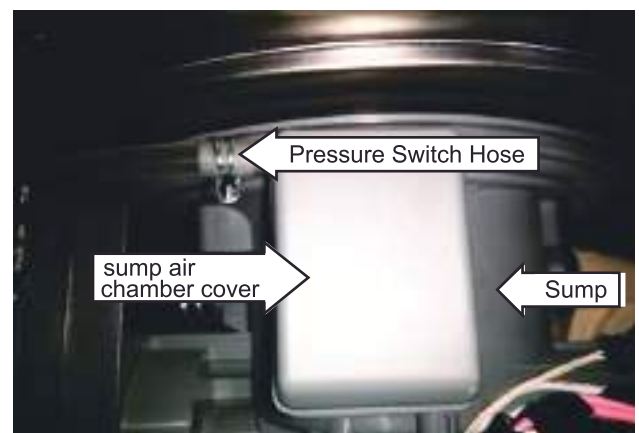

13. Remove the 2 clamps, sump outlet hose, and inlet hose from the sump.

Note: Factory installed hose clamps are not reusable. When installing a water inlet valve, drain pump assembly, wash pump assembly, or sump assembly, replace the old clamps with new screw-type hose clamps provided. The screw-type hose clamps are available separately.

14. Remove the 2 Phillips-head screws that hold the diverter valve motor to the sump.

15. Remove the drain pump from the sump.

16. Remove the inner drain pipe from the sump.

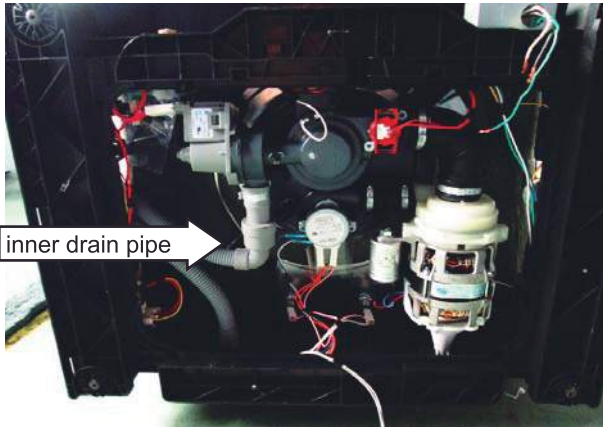

Sump

Front View



Back View

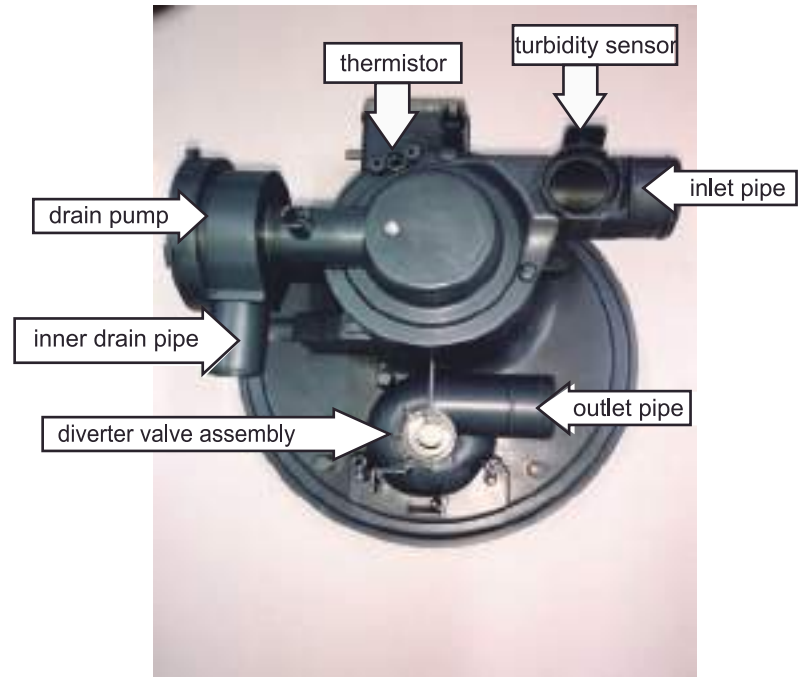

Left View

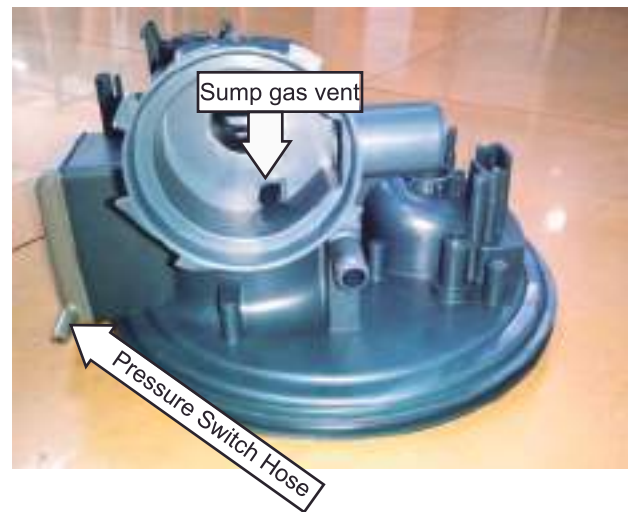

Troubleshooting

Factory Diagnostic Mode

To enter the factory diagnostic mode:

- Turn the dishwasher off and make sure no LEDs light.
- Disconnect power to the dishwasher.
- Reapply power with the door open and quickly press and hold both the **program** and **Star/Cancel** pads within 60 seconds from connecting power.
- Close the door the display will show C0 and F* (* stands for 0,1,2).alternately, each for 1 second. Then the dishwasher will run as below.

NO.	Component	SSD	NOTE
00	Beginning	88	Stand by
01	Water inlet Fan	Turbidity	Turn on water inlet and fan, after 10 seconds turn off the fan. The flow meter will control the water inlet to come in 3.6L water. This step have turbidity detection function ,the SSD will the turbidity value, which between 00-05 is OK.
02	Wash pump Heater Diverter valve motor	04/water temperature	Turn on the wash pump, after 10 seconds, the heater will turn on. The beeper will beep for one time when the temperature has rise for 3 degrees for the first time. The dishwasher will stop when the temperature has arrived 57°C. Press " Start/cancel" to enter the next step.
03	Water pump Dispenser	03	Turn on wash pump for 10 seconds, then turn on the dispenser for 35 seconds more.
04	Pause	02	Pause for 30s.
05	Drain pump	01	Turn on the drain pump for 30 seconds.
06	END	00/F1	Beep one time. The SSD shows "00"and "F*(*(s tands for 0 ,1,)" alternately, each for 1 seconds.

Error Code

Error Code		
Symptom	Error Message	Possible Reason
E1	during the water inlet step, if the flow meter can't detect the defined water after 4 minutes, the dishwasher will warning for E1.	<ol style="list-style-type: none"> 1. check the water supply 2. check the inlet valve 3. check the inlet 4. check the flowmetre 5. check the pressure switch 6. check the drain 7. check the PCB
E3	(only appeared in the factory mode) when the temperature cant reached the defined value after 90 minutes, the dishwasher will warning for E3.	<ol style="list-style-type: none"> 1. check the heater 2. check the thermistor 3. check the PCB
E4	the water flood into the bottom and result in the detective switch moves, the dishwasher will warning for E4.	<ol style="list-style-type: none"> 1. check the use of the detergent 2. check whether the appliance is level 3. check the micro-switch 4. check the drain pump 5. check the amount of the filled water 6. find where leakage is
E6 E7	(only appeared in the factory mode) E6 — thermal sensor cut. E7 — thermal sensor short.	<ol style="list-style-type: none"> 1. check the inlet water temperature 2. check the thermistor 3. check the PCB
E8	Diverter valve assembly problem	<ol style="list-style-type: none"> 1. check the diverter valve motor 2. check the micro S/W 3. check the PCB
E9	when some buttons have been pressed over 30 seconds, the dishwasher will warning for E9.	<ol style="list-style-type: none"> 1. check the control panel assembly
Ed	when the display board cant receive or the main board can't send signal over 20 seconds, the dishwasher will warning for Ed.	<ol style="list-style-type: none"> 1. check the display board 2. check the PCB 3. check the wires connect the display board to the PCB

Schematics and Wiring Diagrams

WARNING: Disconnect electrical power before servicing.

Caution: Label all wires prior to disconnection. Wiring errors can cause improper and dangerous operation. Verify operation after servicing.

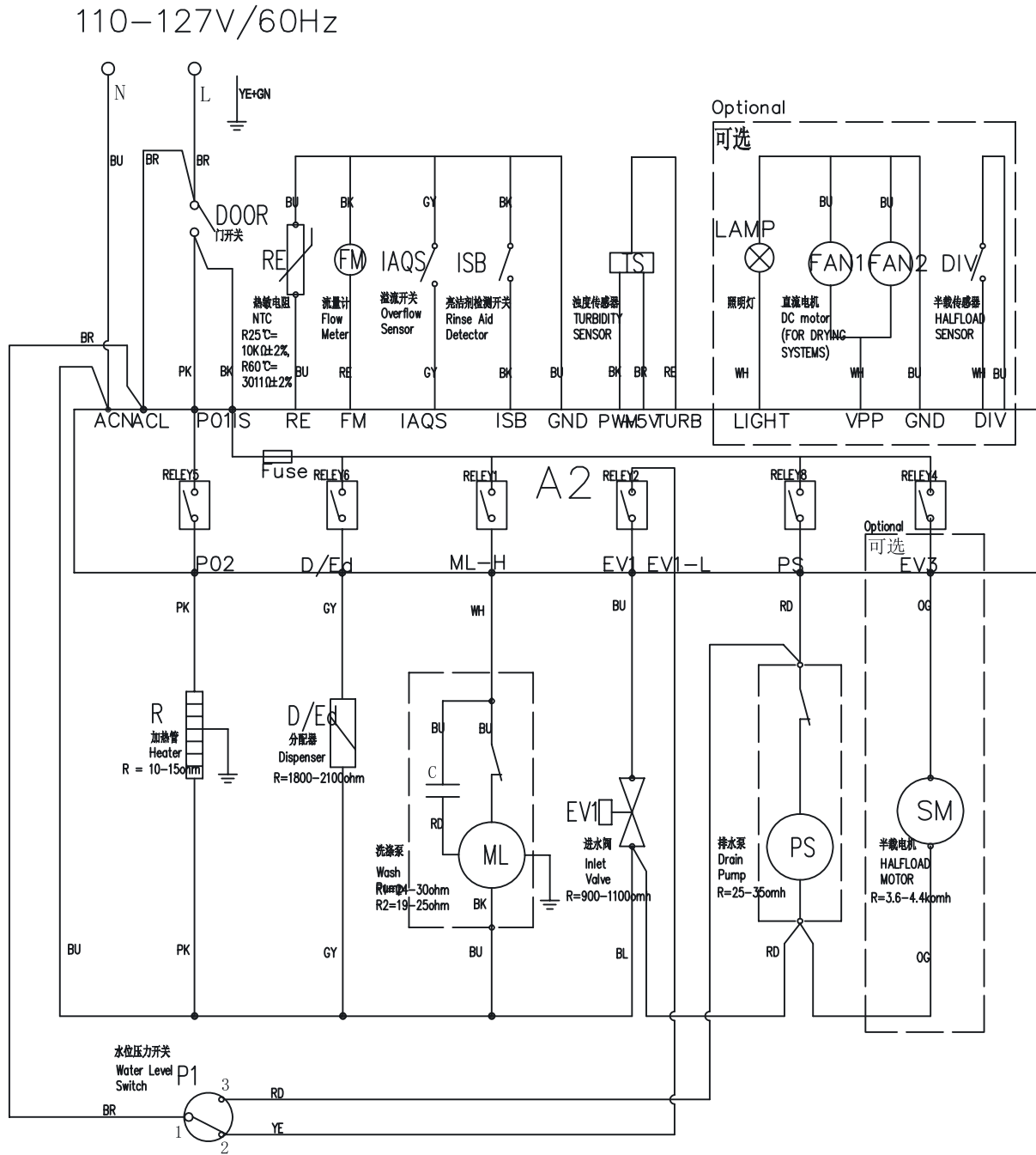



WE TRANSFORM A SIMPLE KITCHEN INTO A PRO ONE.
THIS IS WHY WE CARE ABOUT MAKING VERY HIGH PERFORMANCE
RANGES AND HOODS, TO MAKE YOU FEEL LIKE A PRO AND STYLISH COOKER.

DESIGN: LONDON DC - WWW.LONDON-DC.COM

FOR MORE DETAILS AND INFORMATION, PLEASE VISIT OUR WEBSITE WWW.KUCHT.COM