

FOTILE
A BREATH OF FRESH ENGINEERING™

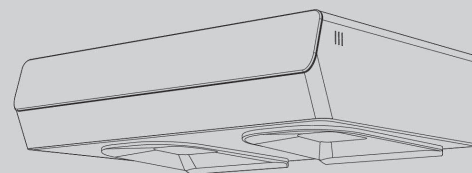

RANGE HOOD Pixie Air™ Series

UQS3001 UQG3002

Use and Care | Installation Guidance P7-P21

CAMPANA EXTRACTORA Serie Pixie Air™

UQS3001 UQG3002

Uso y cuidado | Manual de instalación P31-P46

吸油烟机 Pixie Air™ 灵风系列

UQS3001 UQG3002

使用与保养 | 安装指导 P55-P66

THANK YOU FOR MAKING FOTILE A PART OF YOUR HOME

Thank you for purchasing the series of products elaborately designed and manufactured by FOTILE!

Before use and installation, please read through this manual carefully and follow the instructions as directed. This is of great importance to maintain excellent working conditions of the products and also enables satisfactory experience for you.

It is recommended that you contact FOTILE Service Center any time you need advice, repair or maintenance services so that we can be of service promptly.

FOTILE
Happiness Starts In Your Kitchen!

Table of Contents

Safety Instructions	02
Use and Care	07
Product Specifications	07
Operation Guidance	07
Care and Clean	09
Troubleshooting	11
Customer Services	12
Installation Guidance	13
Safety Instructions	13
Tools and Accessories	16
Specifications	17
Installation Steps	18
CFM Adjustment Technology	21
Explosive View	22

Safety Instructions

To ensure the safe and efficient use of your FOTILE product, please note the highlighted information in the product manual as follows:

- * **Warning:** Indicating a risk of serious bodily injury or death if precautions are not observed.
- * **Notice:** Indicating possible minor personal injury or product damage if instructions are not followed.
- * **Important:** Emphasizing information of critical importance.

Safety Instructions

Please be sure to read these safety instructions before using the product.

Please be sure to properly keep these safety instructions.

This product is for indoor use only.

To avoid any accidental risks and damage to the range hood, please read this product manual carefully before the installation and use. Only in this way can you operate this product safely and correctly and reduce the risks of fire, electric shock, personal injury, etc. Please properly keep this product manual for future use or for subsequent users.

Warning

● Risk of Electric Shock

A defective appliance may cause electric shock. Never switch on a defective appliance. Unplug the appliance from the mains or switch off the circuit breaker in the fuse box in case of problems, and contact our authorized service center.

- The range hood should be connected to a standard power socket with safe grounding. Midway connection, prolonged electric line or multi-socket wiring may cause electric shock, overheating and, in some cases, result in a fire. Installation of the range hood should be performed by professional electricians in strict accordance with electricity standards and regulations of the local area. Before connecting the rod, turn off the power source and take appropriate measures to prevent auto closing of the power switch.
- In order to prevent electric shock and/or other bodily injuries to persons, do not exceed 125V AC input.
- Do not install the range hood in a bathroom and/or a humid area, as this will significantly increase the risk of electric shock.
- If a wire is damaged or defective, contact an authorized service provider or a qualified technician (provided by FOTILE) to replace the wire.
- Do not change, stretch, knot, pressure or squeeze the wire as any resulting damage can result in electrical and/or fire hazards.
- Prevent water from coming into contact with the range hood's electrical components, such as the motor, switch and connector. Do not rinse the appliance with water. Do not use the appliance if it is

wet, as electric leakage and/ or electric shock may occur.

- Do not attempt to change the range hood's internal wiring system. Improper modifications and/or repairs to the internal wiring can result in bodily injuries to persons, electric shock and/or a fire.
 - In order to avoid electric shock, remember to turn off the appliance's power source before installation, cleaning and/or maintenance service.
 - Avoid using high-pressure detergents and/or steam cleaners on the appliance, as they may result in electric shock.
 - Do not touch the plug or switch with wet hands, as an electric shock may occur.
- #### ● Grounding Instructions
- This appliance must be grounded. In the event of an electrical short circuit, grounding reduces the risk of electric shock by providing an escape wire for the electric current. This appliance is equipped with a cord having a grounding wire with a grounding plug. The plug must be plugged into an outlet that is properly installed and grounded.
 - Improper grounding can result in electric shock.
 - Consult a qualified electrician if the grounding instructions are not completely understood, or if doubt exists as to whether the appliance is properly grounded.
 - Do not use an extension cord. If the power supply cord is too short, have a qualified electrician install an outlet near the appliance.

● Risk of Fire

- In order to reduce the risk of fire and to properly exhaust air, we recommend duct the air outside. Do not vent exhaust air into spaces within walls, ceilings, attics, crawl spaces and/ or garages.
- In order to prevent the risk of fire, the range hood should be operated and maintained in accordance to the instructions.
- Hot oils may ignite and burn quickly. Never leave hot oils unattended.
- Clean the hood's oil cup at regular intervals, as leftover grease deposits may ignite.
- Never operate the range hood without the filter.
- Never work with naked flames close to the appliance. Do not install the appliance near a heat-producing appliance for solid fuel (e.g. wood or coal). There must be no flying sparks.
- Avoid cooking with food products that produce flames under the range hood.
- To Reduce Risk of Cooktop Grease Fire:
 1. Never leave the burners work unattended. Overflowing cause smoking and greasy spillovers that may ignite. Heat oils slowly on low or medium settings.
 2. Always turn the hood on during cooking.
 3. Cooking grease may stick on the surface of the kitchen floor, cabinet, vent duct, etc. Better clean regularly to avoid fire risk.
 4. Use proper pan size. Always use cookware appropriate for the size of the pan support.
- To Reduce the Risk of Injury to persons in the event of cooktop fire, observe the following:
 1. Smother flames with lid, cookie sheet,

or metal tray, then turn off the burner. Be careful to prevent burns. If the flames do not go out immediately, evacuate and call the fire department.

2. When the cooking utensil catches fire, switch off the range hood immediately. Effective extinguishing measures must be taken at once, such as covering the open flame with metal cover, turning off the master gas valve and keeping flammable substance from the open flame etc.

3. Never pick up a flaming pan—you may be burned.

4. Do not use water, including wet dishcloths or towels—a violent steam explosion will result.

■ Use an Extinguisher Only If:

1. You know you have a class ABC extinguisher and you already know how to operate it.
2. The fire is small and contained in the area where it started.
3. The fire department is being called.
4. You can fight the fire with your back to an exit.

● Risk of Injury

■ This appliance is not intended for use by persons (including children) with reduced physical, sensory or mental capabilities, or lack of experience and knowledge, unless they have been given supervision or instruction concerning use of the appliance by a person responsible for their safety. Children should be supervised to ensure that they do not play with the appliance.

■ The range hood may have sharp edges. Be careful to avoid cuts and abrasions during installation and cleaning. Do wear qualified protective gloves.

■ The accessible parts become very hot when in operation. Never touch hot parts. Keep children at a safe distance.

■ Do not touch lamps during or soon after operation. Burns may occur.

■ Do not insert your limbs and/or foreign objects into the impeller while the range hood is in operation, as that action might cause injury.

■ This appliance is not intended for operation with an external clock timer or a remote control.

■ Incorrect repairs are dangerous. Repairs may only be carried out and damaged power cables replaced by one of our trained aftersales technicians.

■ If any abnormalities and/or defects occur while operating the range hood, immediately turn off the appliance and unplug the appliance from the mains or switch off the circuit breaker in the fuse box. Then, contact our authorized service center. Abnormal operation and defects may cause hazardous situations, such as electric shocks and fires.

■ This product contains chemicals known to the State of California to cause cancer, and birth defects or other reproductive harm. For more information, please go to: www.P65Warnings.ca.gov

● Risk of Suffocation

■ Packaging material is dangerous to children. Never allow children to play with packaging material, which may cause suffocation. Keep all packing material out of proximity to children. Please remember that packaging materials should not be treated as toys.

● Risk of Death

■ Risk of poisoning from flue gases that are drawn back in. Always ensure adequate fresh air in the room if the appliance is

being operated in exhaust air mode at the same time as room air-dependent heat-producing appliance is being operated. Exhaust gases through the flue (chimney) of fuel burning equipment to prevent back drafting. FOTILE is not responsible for injuries caused by improper and/or incorrect operation of the range hood.

Notice 

● When applicable local regulations comprise more restrictive installation and/or certification requirements, the aforementioned requirements will prevail, and installation personnel must conform to these requirements.

● The operating temperature of the range hood should not exceed 104 °F (40°C).

● Please do not place anything on top of the product. Anything placed on top may fall off or incline. For example, if you place seasoning bottles on top, the inclination may cause liquid to flow inside the product, resulting in damaged electrified components and therefore unnecessary risks. Our company will not bear the responsibility for free repair in case of product damage due to the above reason.

● Clean the oil cup frequently to prevent overflow. The resulting grease is inedible! Please do not place flammable materials in the oil cup, such as plastic wrap, paper towels, etc.

● When cutting or drilling into the wall or ceiling, be careful not to damage electrical wiring, water pipes, gas lines, or other hidden utilities.

● Adhere to the heating equipment manufacturer's guidelines and safety standards, such as those published by the National Fire Protection Association (NFPA), the American Society for Heating, Refrigeration and Air Conditioning Engineers (ASHRAE) and the local code authorities. Meanwhile, conform to the

safety standards issued by such administrative departments as fire department.

● When gas burners are in operation without any cookware placed on them, they can build up a lot of heat. A ventilation appliance installed above the cooker may become damaged or catch fire. Only operate the gas burners with cookware on them.

● Adhere to the voltage and frequency settings listed in this manual to avoid possible damages to the range hood.

● Please use standard accessories provided by our company to prevent the range hood from falling down accidentally. The hole drilled in the wall should precisely match the size of the expansion pipe, otherwise, the range hood may loose and fall down.

● Tempered glass is applied to the products of the company and the tempering treatment of the glass determines the extremely little possibility of spontaneous explosion. If the occurrence of spontaneous explosion is not due to improper use, our company promises free replacement of the accessories. The possibility of tempered glass breaking can be significantly increased in the following situations, which should be avoided: For instance, hitting the glass, especially the corners of the glass, with cooking utensils or other hard objects; The glass is impacted when you open a cabinet door around the Range Hood; Put the glass in an extremely hot or cold environment or an environment where heat and cold are excessively alternated.

● Unauthorized modification of this product can lead to risks.

Important

- This appliance is intended for indoor home cooking only; it cannot be used for outdoor cooking. Please use this product only according to the manufacturer's instructions. FOTILE assumes no responsibility if you use it in special environment. Please contact a FOTILE authorized service center if you encounter any problem.
- Check the appliance for damage after unpacking it. If you detect any obvious damage to the product, do not proceed with the installation. Please contact our authorized service center immediately.
- Avoid placing gypsum powder, construction dust, etc. within close proximity of the range hood.
- Operate the range hood only in the manner outlined in this product manual. When operating the range hood, do not leave the appliance unattended. If you have any questions and/or concerns, please contact our authorized service center.
- Operate, clean and maintain the range hood in accordance to the instructions outlined in this manual.
- Clean the metal grease filter according to the instructions.
- The range hood's motor has a thermal overload function, which automatically turns off the motor when it overheats. Once the motor cools down, the range hood will automatically restart. If the motor, continually turns off and restarts, please contact our authorized service center.
- If the range hood has not been in operation for an extended period of time, unplug the appliance.
- Please make sure correct installation and maintenance of the appliance. Installation work and electrical wiring must be done by qualified person(s), in accordance with all applicable codes and standards, including fire-rated construction codes and standards. The installation personnel should be responsible for normal operation of the appliance at the installed position.
- Please install the damper according to the national or local codes if you need.
- For general exhausting only. Do not use this range hood to exhaust hazardous and /or explosive materials or gas.
- The product itself is nonflammable.
- In order to reduce the risk of fire, all exhaust pipes, flues and devices should be nonflammable. Use only metal duct cover and metal duct pipes. Never cover the hood with flammable plastic film or paper.
- Services guaranteed under warranty must be performed by FOTILE certified service provider or personnel. The warranty is not effective for products removed for repair without authorization.
- Please read the specification label on the range hood for further information and requirements.
- Please install a supplementary air device if you install the high-power Range Hood in an airtight room. Due to the configuration of the FOTILE Range Hood, it is recommended for users with an airtight new house to install a supplementary air device. Please comply with relevant regulations to install corresponding supplementary air device if there are relevant regulations in your state or region.
- This product is for use in the U.S. and Canada only.

Use and Care

Product Specifications

		Pixie Air	
Model		UQS3001	UQG3002
Certification		ETL	ETL
Product Size	Width	29 13/16inches (757mm)	29 13/16inches (757mm)
	Depth	22 1/16inches (560mm)	22 1/16inches (560mm)
	Height	8 5/16inches (210mm)	8 5/16inches (210mm)
Voltage/Frequency		120V/60Hz	120V/60Hz
Power		256W	260W
Led Lights		3W×2(LED)	3W×2(LED)

Operation Guidance

Warning





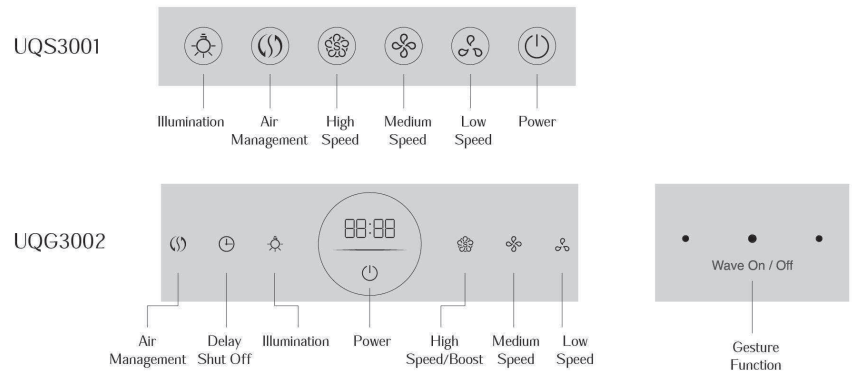







- Avoid sudden or violent button operation.
- Avoid empty burning of the stove that directly bake the range hood.
- Avoid disassembly with power on or against the instructions.
- Avoid the overflow of the capture-shield plates (integrated oil cups).
- Avoid disassembly and inspection by non-professional personnel.

Operation Interface







Operation Guidance

UQS3001

1. **Power:** By pressing it briefly when the range hood is off, the hood enters the standby mode,  the power indicator is fully lit; by pressing it briefly when the range hood is on, all the functions are off, the key indicator is off, and the range hood is in off state.
(If no operation is made for 2 minutes in standby state, the range hood will be off automatically)
2. **High:** By pressing it briefly, the fan is started, the  High indicator is fully lit, the range hood operates at High speed; by pressing it briefly again, the motor stops running, and the  High indicator is off.
3. **Medium:** By pressing it briefly, the fan is started, the  Medium indicator is fully lit, the range hood operates at Medium speed; by pressing it briefly again, the motor stops running, and the  Medium indicator is off.
4. **Low:** By pressing it briefly, the fan is started, the  Low indicator is fully lit, the range hood operates at Low speed; by pressing it briefly again, the motor stops running, and the  Low indicator is off.
5. **Illumination:** By pressing it briefly, the LED lights are on, the  illumination indicator is fully lit; by pressing it briefly again, the LED lights are off, and the  illumination indicator is off.
6. **Air Management:** By pressing it briefly, the  Air Management indicator blinks in green, and the range hood enters the state of intelligent detection of air quality. If the air quality is excellent, the  indicator is constantly on in green, if the air quality is relatively poor, the  Air Man-





agement indicator is constantly on in pink. The range hood operates at Low speed; if the air quality is poor, the  Air Management indicator is constantly on in red, the range hood operates at High speed.

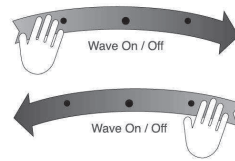

UQG3002











1. **Gesture Function:** In off state, wave  swiftly before the sensor in the upper right, the range hood operates at  High speed. The  LED lights are on to full brightness. In any state other than off state, wave  swiftly before the sensor, all the functions of the range hood are off, all the displays are out, and the range hood is off.







Ps:

- (1) The distance between hand and the function area should be no more than 5in.
 - (2) During cooking, please turn on the range hood. Otherwise, steam/smoke passing through the sensor area may trigger the gesture function.
2. **Power:** By pressing it lightly when the range hood is off, the hood enters the standby mode, the  large light ring and the  power indicator are fully lit, and all buttons (except the delay-off) are slightly lit; by pressing it lightly when the range hood is on, all displays are off, the key indicator is off, and the range hood is in off state.
 3. **High/Boost:** By pressing it lightly, the fan is started, the  indicator is fully lit, and the range hood operates at High speed; then by pressing  it again, the motor stops running, the  indicator is slightly lit.

By pressing and holding, the  indicator is constantly on in green, the range hood operates at Boost; operate the same again, the range hood returns to High speed, the  indicator is fully lit.

4. **Medium:** By pressing it lightly, the fan is started, the  Medium indicator is fully lit, the range hood operates at Medium speed; by pressing  it lightly again, the motor stops running, and the  Medium indicator is slightly lit again.
5. **Low:** By pressing it lightly, the fan is started, the  Low indicator is fully lit, the range hood operates at Low speed; by pressing  it lightly again, the motor stops running, and the  Low indicator is slightly lit again.
6. **Illumination:** By pressing it lightly, the LED lights are half lit, the  indicator is also half lit; by pressing it lightly again, the LED lights are fully on and the  indicator is fully lit; then by pressing it lightly the third time, the lights are off, the  indicator is slightly lit again.
7. **Delay Shut Off:** When the range hood is in operation, that is, at least one function (fan, Air Management, illumination) is activated, by pressing the button lightly, the  Delay indicator is fully lit, the range hood enters the 5-minute delay mode; then by pressing it light again, the range hood enters the 15-minute delay mode; by pressing the button the third time, the range hood exits the delay mode, the  Delay indicator is slight lit again, and the range hood maintains current working conditions.
When the range hood is in Delay mode, the screen displays the remaining time. After the delay time expires, all functions are closed, all displays are out, and the range hood is switched off.

The Delay function is invalid when the range hood doesn't work.

8. **Air Management:** By pressing it lightly, the  indicator is fully lit, the  large light ring blinks in white, and the range hood enters the state of intelligent detection of air quality. If the air quality is excellent, the  ring turns green, if the air quality is relatively poor, the  ring turns yellow. The range hood operates at Low speed; if the air quality is poor, the ring  is red. The range hood operates at High speed.

Care and Clean

Warning

- Failure to clean as specified in this instruction manual may result in risk of electric shock, fire, personal injury, etc.
- Protect electrical components such as motors and control buttons from water during cleaning. Moisture entering the circuit may result in product damage or personal danger.
- Do not clean the range hood with gasoline, acids, benzene, solvents, or any other chemicals.
- Do not clean with rough materials such as cleaning balls or rough cloths, and please do not use strong or abrasive detergents to prevent scratching the machine.
- Electric shock hazard
 - Moisture penetration may result in electric shock. Before cleaning and maintaining the range hood, disconnect the power supply to avoid electric shock.
 - Do not use any high-pressure cleaning machines or steam cleaning devices that could result in electric shock.

● Fire hazard

- Grease deposits on the capture-shield plates (integrated oil cups) may catch fire.
- Do not place flammable materials such as plastic wrap and kitchen paper in the capture-shield plates (integrated oil cups).

● Personal injury hazard

- The range hood may have extremely sharp edges, and when cleaning and maintaining the range hood, wear certified protective gloves to prevent injury.
- When the fan is in operation, do not put the hands into the operation area of the fan to avoid injury.
- When the product is in operation, the top metal surface and LED lights may become hot, so please do not touch the corresponding area to avoid burns.

Notes 

- Corrosion (including condensed liquids from not opening the hood while cooking) can result in damage.
- Please clean only along the texture of the stainless steel surface to avoid surface damage.
- Do not use any stainless steel cleaner to clean the buttons or other control components to avoid surface damage.

Important 

- Be sure to install the capture-shield plates (integrated oil cups) in place after each cleaning.
- Do not use the range hood without capture-shield plates. It may pose a safety hazard.

Recommended Cleaning Methods

- Tempered Glass: Use soft cloth to wipe the surface, better with the neutral detergent.
- Stainless Steel: Use soft cloth to wipe the surface, better with the neutral detergent or a stainless steel cleaner or polish.
- Capture-shield plates: After cooking, use the kitchen towel to wipe. Take down the plates with your hands (avoid excessive tilting to prevent spillage), then soak with hot water, rinse and clean. Or just put into your dishwasher.
- If you need other maintenance service, please contact FOTILE service.

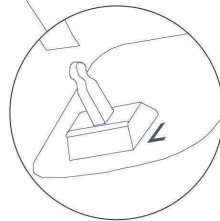
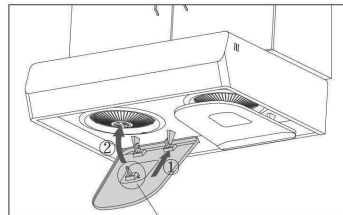
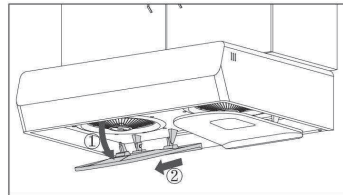

Disassembling and assembling of the capture-shield plate (integrated oil cup)

Troubleshooting

Troubleshooting Tips Before you call for service

Troubleshooting		
Problem	Problem Cause	What To Do
The range hood doesn't work.	The power is not on.	Please confirm that the power cord is connected, and the power is on.
	The power line of the switch or control panel becomes loose.	Contact a professional technician or consult FOTILE customer service.
The indicators are normal. However, the fan doesn't work.	Power board failure.	Contact a professional technician or consult FOTILE customer service.
	Capacitor failure.	Contact a professional technician or consult FOTILE customer service.
The range hood shakes sometimes in working.	The impellers may become loose.	Contact a professional technician or consult FOTILE customer service.
	The range hood is not firmly secured with the cabinet.	Tighten the screws at the bottom of the cabinet to ensure that the hood is tight against the cabinet.
The fan works, but the light won't be lit.	Loose wiring	Contact a professional technician or consult FOTILE customer service.
	LED light failure	Contact a professional technician or consult FOTILE customer service.
Ventilation is weak.	The range hood is installed too high.	Refer to the installation instruction manual, and ensure that the bottom of the hood is 24in - 28in from the cooktop.
	Airflow from open windows, doors or air condition interferes with the operation of the range hood.	Reduce airflow fluctuations when using the range hood.
	Blocked ducts or vents.	Check the ducts and vents, remove the objects, if any.
	There is a headwind in the direction of the outlet.	Adjust the direction of the air outlet, or install a rain shield to reduce the effect of the wind.
	The diameter of the duct is smaller than the ideal size.	Adjust the size of the duct.

How to replace the LED light:

1. Unplug the range hood.
2. Slightly insert the edge of the LED light with a small word screwdriver and pry the LED light down.

3. Disassemble LED light cable and replace with a new one.

Note: When inserting the LED light, please make sure the side with the wires facing the filter.

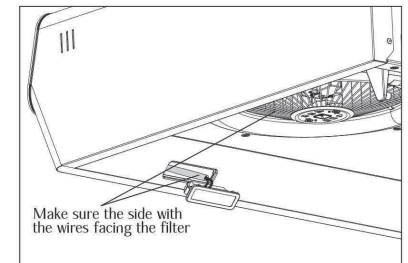
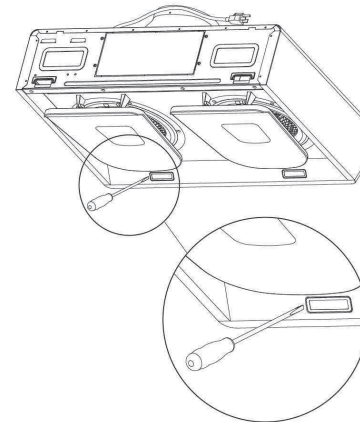

Customer Services

It is recommended that you read the following warranty terms first in case that services are required.

Warranty for Range Hood:

For range hood purchases made on or after 11/15/2019.

FOTILE is offering (from the date of purchase) five years limited warranty on range hood, life time limited warranty on motors.

TWO (2) YEARS FULL WARRANTY ON ALL FOTILE RANGE HOOD PARTS AND LABOR AND THREE (3) YEARS LIMITED WARRANTY ON ALL PARTS OF FOTILE RANGE HOOD PRODUCTS*

*Please visit <https://www.fotileglobal.com/us/Service%EF%B-Cz86Support.html> to read the full warranty terms.

What FOTILE America will not cover under Warranty:

- Service trips to your home to provide tutorials on the use and maintenance knowledge.
- Improper installation, delivery or maintenance.
- Failure of the product if it is abused, misused, modified or used for other purpose or used commercially.
- Damage to the product caused by improper clean.
- Damage to the product caused by accident, fire, floods or acts of God.
- Damage to the product caused by use beyond normal conditions, eg. Higher voltage.
- Product without registration or wrong information according to the registration.

Exclusion of Implied Warranties:

This warranty is extended to the original purchaser and any succeeding owner for products purchased for home use within the USA. If the product is located in an area where service by a FOTILE Appliances Authorized Service Technician is not available, you may be responsible for a trip charge or you may be required to bring the product to an authorized FOTILE Service location for service. In Alaska and Hawaii, the warranty excludes the cost of shipping or service calls to your home. Some states do not allow the exclusion or limitation of incidental or consequential damages. This warranty gives you specific legal rights, and you may also have other rights which vary from state to state. To know what your legal rights are, consult you local or state consumer affairs office or your state's Attorney General.

Product Registration

● If you have purchased a FOTILE range hood, please register your product as soon as possible. This allows us to communicate with you and provide you with services in a timely manner upon your request. You may register your product in two ways as follows:

■ A printed registration card is enclosed in the product package. You may fill in the information and mail it to FOTILE.

■ Visit the official website of FOTILE for product registration:
<https://shop.fotileglobal.com/register-today-for-product-support>

● If you have purchased a FOTILE range hood, please inform us of the model and serial number of the product when you communicate with us so that we can serve you better.

You can find such information at the location shown below:

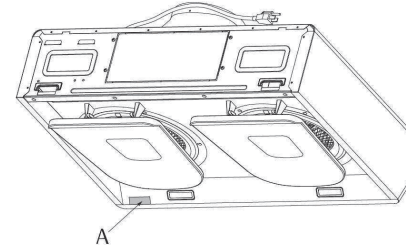

- To order accessories, you may:
 - Visit the official online store of FOTILE: <https://shop.fotileglobal.com/>, to find information and place orders.
 - Call Toll Free of FOTILE: 1(888)-315-0366, to seek for consultations and place orders.
 - Contact FOTILE authorized stores (visit the FOTILE website to find an authorized store in your city) for inquiries and purchases at <https://www.fotileglobal.com/us/>
- In case of other services you need, you may contact FOTILE at:
 - Toll Free: 1(888)315-0366
 - Customer Service Email: serviceusa@fotile.com
(Please leave your phone number available for contact during the daytime)
 - Mail Address: 6 Campus Dr, Suite 210, Parsippany, NJ 07054

Installation Guidance

Safety Instructions

To ensure the safe and efficient use of your FOTILE product, please note the highlighted information in the product manual as follows:

- * **Warning:** Indicating a risk of serious bodily injury or death if precautions are not observed.
- * **Notice:** Indicating possible minor personal injury or product damage if instructions are not followed.
- * **Important:** Emphasizing information of critical importance.

Safety Instructions

Please be sure to read these safety instructions before using the product.

Please be sure to properly keep these safety instructions.

This product is for indoor use only.

Warning

- In order to reduce the risk of fire, electric shock, or injury to persons, please carefully read the following:
 - The installation and wiring of the appliance should only be carried out by a professional electrician in accordance with current national or local electric safety regulations, including fire-rated construction. Non-professional personnel should not conduct installation. Proper installation is the responsibility of the installer. Product failure due to improper installation is not covered under the FOTILE warranty.
 - Please use standard installation equipment and tools provided by FOTILE to ensure safe installation. Make sure to use the expansion tube and expansion bolt provided by our company, in case the range hood falls down accidentally. The hole drilled into the wall should precisely match the size of the expansion tube, otherwise the range hood will not be properly secured to the wall and may fall down.
 - The range hood should be connected to a standard power socket with safe grounding. The midway connection, prolonged electric line or multi-socket wiring may cause electric shock, overheating and even fire. Power off before wiring and make sure proper measures have been taken to avoid unexpected connection.
 - During the installation, switch off the circuit breaker in the fuse box during installation. If the supply cord is damaged, it must be replaced by a special cord or assembly available from the manufacturer or its service agent.

- The appliance should only be installed, removed and maintained by qualified technicians to prevent risks like electric shocks, falling or fires from occurring.

● Risk of Injury:

- Unplug the appliance from the mains or switch off the circuit breaker in the fuse box before installation, cleaning, maintenance and repair in order to avoid electric shock.
- The range hood may have sharp edges. Be careful to avoid cuts and abrasions during installation and cleaning. Do wear qualified protective gloves.

● Warning Before Installation

- Prior to installation, ensure that the exhaust outlet is free of debris, as they may damage the range hood.
- A straight and short ducting run will ensure high performance of the range hood.
- A curving and long ducting run should be avoided, as it will lower the performance of the range hood.
- Strictly seal the connection between the duct and duct hole with duct tape. Ensure that the connection between the duct and the duct cover is secure, and seal it with aluminum tape.
- A small duct hole will lower the performance of the range hood. Therefore, it is highly recommended that your duct hole equal to or larger than 7" (178mm) of the size.
- The bolts used in this product are metric-size bolts, please do not apply any unqualified bolts.

Notice

- Please carefully read all instructions prior to installation. Please give special consideration to the following items:
 - If you are renovating your kitchen, be careful to not expose the exterior of the range hood. Building materials, dust, paint, coating, and gases will corrode and tarnish the surface of the range hood. It is recommended that you install the range hood after all renovations are completed.
 - If you need to remove your gas burner before installation, please turn off the main gas valve first.
 - Do not connect the range hood duct to a duct used to exhaust hot air or fumes from another appliance.
 - Two installers are recommended due to the large size and heavy weight of the range hood. Since the installation is complex and the appliance is heavy, professional installers are required to install the appliance as outlined in this manual.
 - After the appliance fixed, the plug should be accessible.
 - Make sure to keep the appliance horizontally.
 - Ensure that the appliance functions normally after the installation is complete.

Important

- Prior to installation, please read the FOTILE Range Hood Installation carefully and save it for the local inspector's future reference.
- This appliance must be installed in accordance with National Electrical Codes, as well as all state, municipal and local codes.
- The appliance must be equipped with safe circuit breaker and installed with safe grounding.
- The correct voltage, frequency and amperage must be supplied to the appliance according to the proper voltage, frequency and amperage ratings listed on the product rating plate.
- This installation must be completed by FOTILE authorized service center, or certified installers.
- Please record the model and serial number before installing the range hood. Position of plaque can be referred to in figure A as follows:

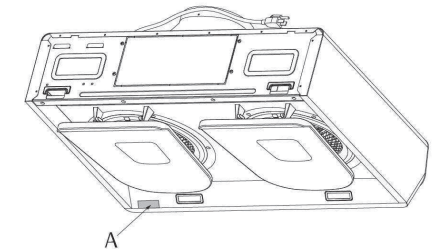

Tools and Accessories

Tools and Materials Required
(NOT SUPPLIED)



Accessories

Packing List

Parts with rang hood	
manual book	1
warranty card	1
mounting paper	1
range hood	1
capture-shield plate (integrated oil cup) (left)	1
capture-shield plate (integrated oil cup) (right)	1
mounting bracket	1
vent duct gasket	1
plastic anchors (for tile) $\Phi 1/4" \times 1 5/16"$ ($\Phi 5.3 \times 32\text{mm}$)	4
plastic anchors (for drywall) $\Phi 3/16" \times 1 5/8"$ ($\Phi 4 \times 40\text{mm}$)	4

bracket screws $\#8 \times 1 7/16"$ (ST4.2×36mm)	4
wood screws $\#10 \times 2 9/16"$ (ST5×65mm)	4
screws for vent duct $\#8 \times 3/4"$ (M4×18mm)	8
fixing screws $\#10 \times 2 13/16"$ (M5×70mm)	4 (1 for spare)
fixing-screw washers $\Phi 1 5/16"$ ($\Phi 32\text{mm}$)	4 (1 for spare)

Vertical Duct Parts with rang hood	
vent duct	1
Horizontal Duct Parts with rang hood	
square vent duct	1
rubber pad	1
vertical cover plate	1

Specifications

		Pixie Air	
Model		UQS3001	UQG3002
Product Size	Width	29 13/16inches (757mm)	29 13/16inches (757mm)
	Depth	22 1/16inches (560mm)	22 1/16inches (560mm)
	Height	8 5/16inches (210mm)	8 5/16inches (210mm)
Voltage/Frequency		120V/60Hz	120V/60Hz
Power		256W	260W

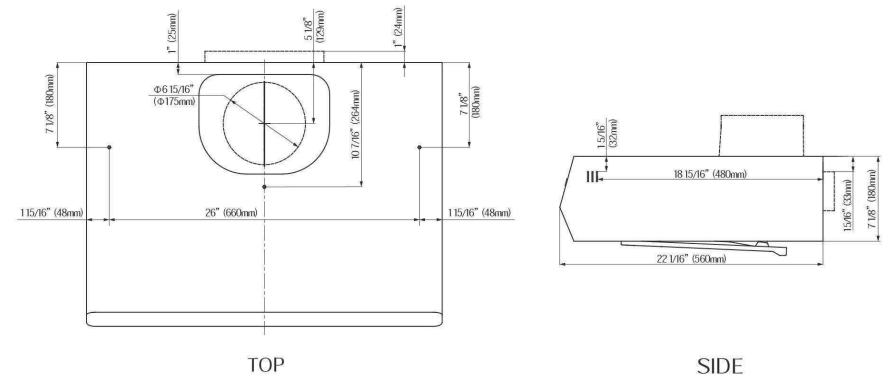

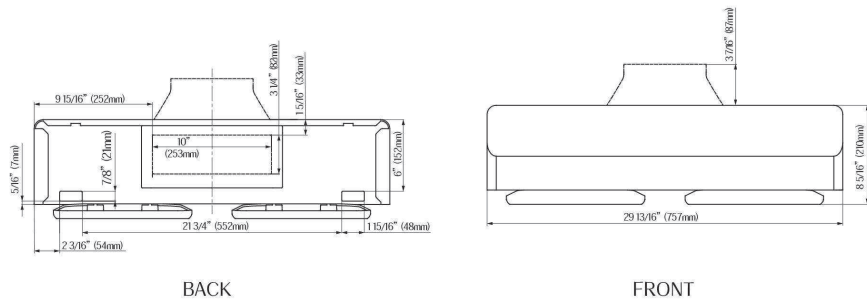

Installation Steps

Cabinet Requirements

In order to secure the safe use of the range hood and maximize its ability to ventilate cooking fumes, the installation height is suggested as follows: The distance from the countertop of the gas stove to the top board of the range hood shall not be less than 24" (610mm) and shall not be more than 28" (710mm). Where there are relevant laws stipulating the mounting height of range hood in the state or region, the laws shall prevail (Included but not limited to architecture and firefighting regulations and standards). However, the effect of cooking fumes ventilation might be affected.

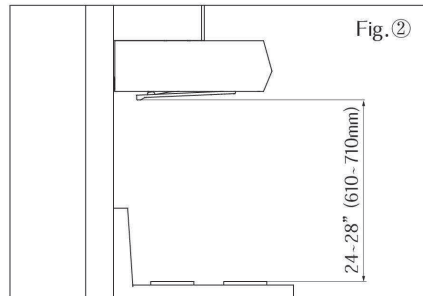
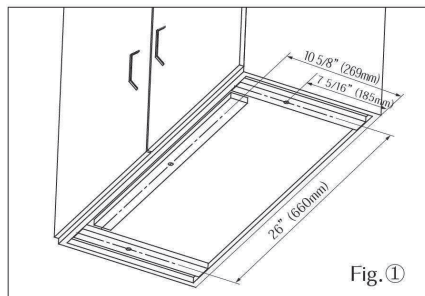

As shown in Fig. ①.

For cabinets with recessed bottoms, to install FOTILE under-cabinet range hood of 30in, please fill the bottom of the cabinet with 3 strips of wood (to be purchased separately, recommended width 1in-1 1/2in), making sure the bottom fixed with range hood is flat.

As shown in Fig. ②.

The minimum distance above the cooktop or range must not be less than 24". A maximum of 28" above the cooktop or range is highly recommended for best capture of cooking impurities.

Installation Guide

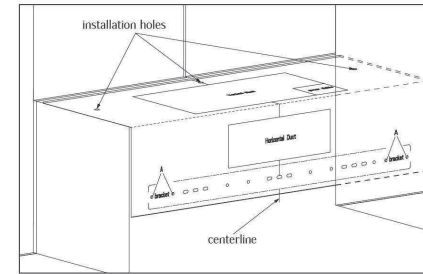

1. Unpack and confirm packing list and check product appearance.
2. Measure and mark the centerline of the wall on which the range hood will be installed.
3. Locate and mark the wooden posts within the installation wall with professional tools
4. Fold the mounting paper along the dotted line to 90°.
5. Fix the mounting paper: stick the back side of "Horizontal Duct" to the back wall, align the centerline with the wall centerline. Make sure the back side of "Vertical Duct" is close tightly to the bottom surface of the upper cabinet.
6. Finish openings of the 3 installation holes and bracket holes.
7. Finish openings of the corresponding duct area.

Note: If the upper cabinet is with recessed bottom, please follow the operation of the Fig. ① shown above.

Note: There're 4 holes marked with A located on both ends in the bracket, they must be opened.

Note: If it's horizontal duct, please make sure finish the opening for the electric wire on the bottom of the upper cabinet.

8. Remove the mounting paper and install the bracket.

Note:

- Please choose the appropriate fixing screws according to the wall material.
- The 4 holes marked with A must be screwed.
- There must be at least 1 wood screw (#10x2 9/16" or ST5*65mm) to fix the mounting bracket to the wooden post in the back wall to support the load.

9. Install the range hood.

◇Vertical Duct

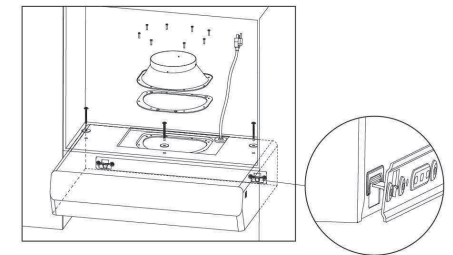

- 9.1 Lift the hood and insert mounting bracket into the back holes of the product.
- 9.2 Hold the hood up against the bottom of the cabinet and secure with 3 screws (#10x2 13/16" or M5*70mm) and gaskets (Φ1 5/16" or Φ32mm).
- 9.3 Place the vent duct gasket on the air outlet.
- 9.4 Fix the vent duct with #8x3/4" or M4x18mm screws.
- 9.5 Attach the pipe and seal it with professional sealing tape.
- 9.6 Connect the power wire.
- 9.7 Peel off the protection film from the capture-shield plates (integrated oil cups) and install them in places.

Note: Do not confuse the left and right capture-shield plates (integrated oil cups).

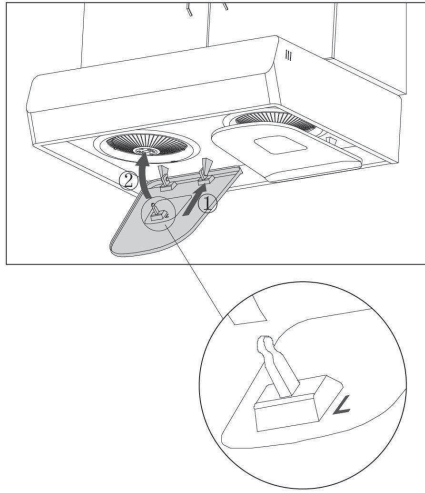

◇Horizontal Duct

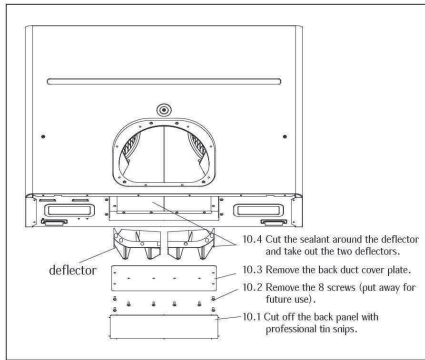

Step 10.1-10.4, please refer to the Figure above.

10.5 Hang the rubber pad onto the edge of the square vent duct and fix the duct to the back of the hood with the 8 screws that are collected previously.

10.6 Place the vent duct gasket on the air outlet with the gap facing down and then fix the vertical cover plate with 8 long screws #8x3/4" or M4x18mm.

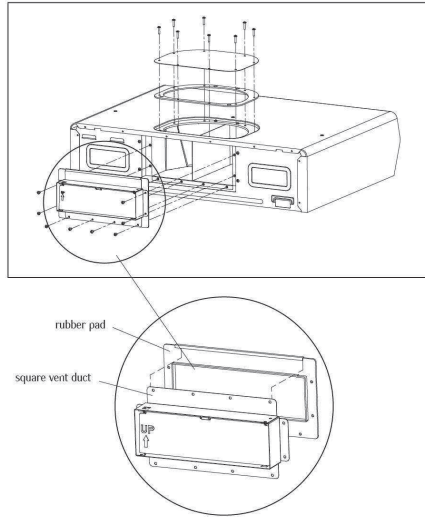

10.7 Lift the hood. Firstly, run the power wire through the pre-drilled hole, then push the hood horizontally until it is pressed firmly against the back wall.

10.8 Hold the hood up against the bottom of the cabinet and secure with 3 screws (#10x2 13/16" or M5*70mm) and gaskets (Φ1 5/16" or Φ32mm).

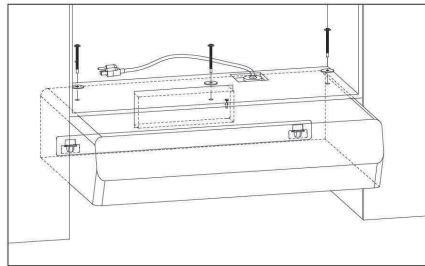

10.9 Connect the power wire.

10.10 Peel off the protection film from the capture-shield plates (integrated oil cups) and install them in places.

Note: Do not confuse the left and right capture-shield plates (integrated oil cups).

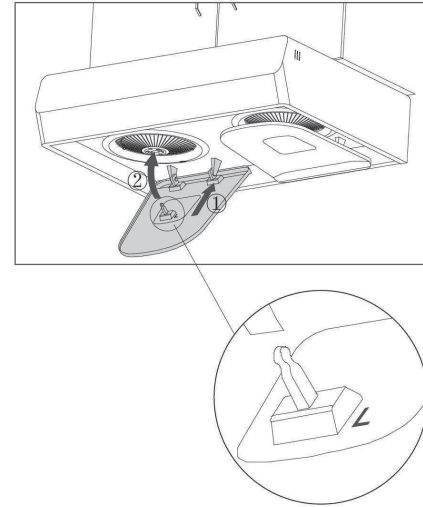

CFM Adjustment Technology

CFM Adjustment Technology (CAT)

Some local codes or regulations have limits on CFMs. FOTILE CAT function of Pixie Air series enables the builders/installers/contractors to set the maximum CFM no more than 400CFM. Or the consumers may prefer to enjoy more effective ventilation with a make-up air system.

Under CAT state and normal state (i.e., ex-factory state), the motor speeds corresponding to the airflow are as follows:

Air Flow	Speeds corresponding to different conditions	
	CAT Status	Normal Status
Boost	Function Failure	P4
High	P2	P3
Medium	P2	P2
Low	P1	P1

Operation Instructions:

1. Under normal state with the product in OFF state, press and hold the and slightly, the indicators are constantly on.

* For UQG3002, please turn on the power first and use mark pen to mark the icon and slightly.

2. Press High Speed and hold for 3 seconds in 10s and the buzzer will sound a long beep: If it's UQS3001, the Air Management indicator turns green.

If it's UQG3002, the Light Ring is displayed in green.

3. All indicators are out after 2s, the product will be in off mode.

4. The range hood is with CAT function. That is, the speed related to High/Boost is switched to P2 (the same speed as Medium, less than 400CFM).

* If no operation with the combination buttons in 10s, the range hood returns to the factory-set off state.

CAT Self-examination:

If you want to check whether the range hood is with CAT or not,

1. Under normal state with the product in OFF state, press and hold the and slightly, the buttons are constantly on.

2. In case of CAT state: For UQS3001, the Air Management is constantly on in green, and the other indicators are constantly in white.

For UQG3002, the Light Ring is constantly on in green, and the other indicators are constantly in white.

3. In case of a non-CAT state, the indicators are constantly on in white.

After 2s, all indicators are out, and the product is in off mode.

Explosive View

UQS3001

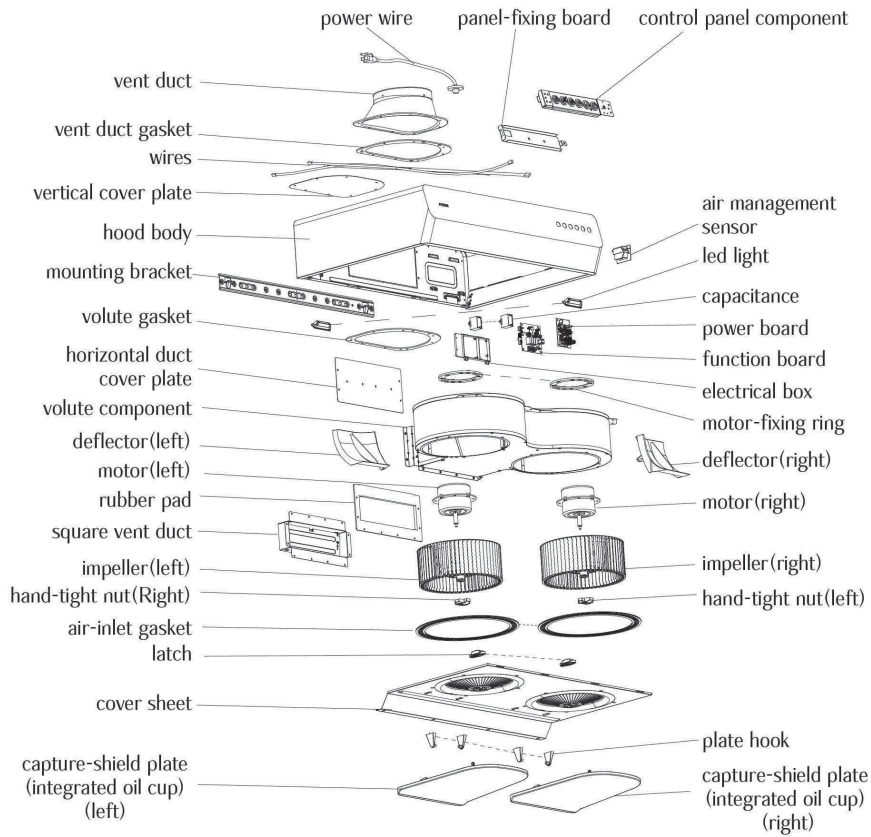

UQG3002

