

# VEROBOARD®

## Model: VBD-N1212-SF-B

Material:	Silicone
Colour:	Black
Beam Angel:	120°
Channel Length:	10m (32.8ft) Max
Channel Width:	12mm (0.47")
Channel Height:	12mm (0.47")

Job Name: \_\_\_\_\_

Distributor: \_\_\_\_\_

Type: \_\_\_\_\_

VBD-N1212-SF-B (5 meters)

**SKU: 666561432683**



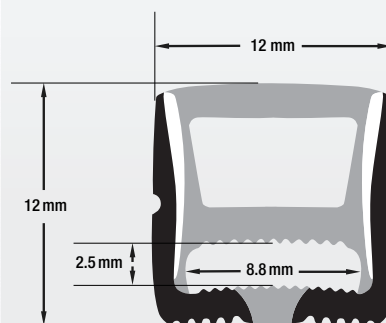

Model: VBD-N1212-SF-B

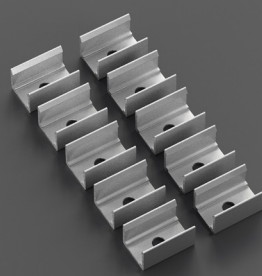
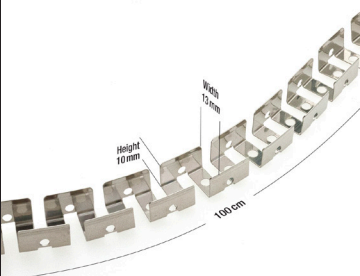

**VBD-N1212-SF-B** is designed to meet your needs with exceptional performance and quality. Please note that while this product is built to excel in various conditions, it is not recommended for extended exposure to strong UV rays or direct sunlight. If you intend to utilize the **VBD-N1212-SF-B** outdoors, we strongly recommend providing ample shade or protective cover to shield it from direct sunlight.

## ACCESSORIES (Sold Separately)

End Caps (1 Pair/bag)	Mounting Clips (10 PCs/bag)	Flexible Clips (1 Meter)	Linear Mounting (1 Meter)
 <p>Model: VBD-EN1212-B SKU: 666561432690</p>	 <p>Model: VBD-CLN1212-MC SKU: 666561432720</p>	 <p>Model: VBD-CLN1212-FC SKU: 666561432706</p>	 <p>Model: VBD-CLN1212-LI SKU: 666561432713</p>

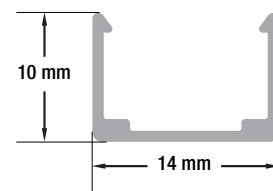
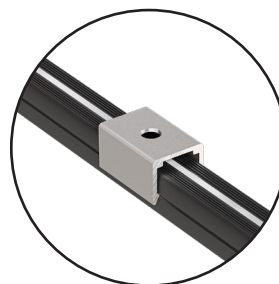

# VEROBOARD®

**LED Type:** VBDFS-E2835-XXXX-168-24-NS-8  
**Colour:** 2700K • 3000K • 3500K • 4000K • 5000K

	Wattage	Brightness
Per Foot	3.5W/ft	450Lm/ft
Per Meter	12W/m	1475Lm/m



**Job Name:** \_\_\_\_\_

**Distributor:** \_\_\_\_\_

**Type:** \_\_\_\_\_

## DESCRIPTION

Flexible 8mm-wide linear LED strip, specially designed for our Flexible Neon Channels, does not include double-sided 3m tape so that it can be easily inserted into the neon channel. can be cut every 7 LEDs (42mm or 1.63 inches). These LED strip lights are crafted from premium materials and engineered for professional lighting applications. Each strip light starts with a robust dual-core copper printed circuit board (PCB), which is then fitted with an array of chips and color options through soldering.

## DIMENSIONS

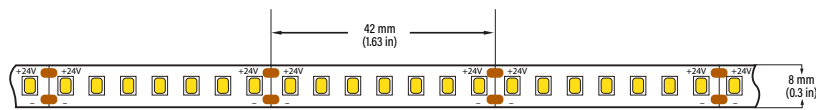

## SPECIFICATIONS

<b>Model:</b>	VBDFS-E2835-xxxx-168-24-NS-8
<b>Color Temperature:</b>	2700K • 3000K • 3500K • 4000K • 5000K
<b>LED Type:</b>	2835 SMD
<b>LED Qty:</b>	168 LEDs per meter
<b>Input Voltage (VF):</b>	24V DC
<b>Power:</b>	12W per meter (3.5W/ft)
<b>Brightness:</b>	1475 Lm/meter (450 Lm/ft)
<b>Lifespan:</b>	>50,000 hours
<b>PCB:</b>	4oz PCB, Double-side, white colour 8mm width
<b>Rendering Index (Ra):</b>	CRI>95
<b>Beam Angle:</b>	120°
<b>Dimmable:</b>	Yes
<b>Cut Size:</b>	Every 7 LED chips (1.63")
<b>Operating Temperature:</b>	-15°C to +40°C
<b>Dimensions:</b>	8mm (0.3")
<b>Certificates:</b>	UL / RoHs



666561433147  666561433154  666561433161



666561433178  666561433185



Back Side



## COMPATIBLE SILICONE NEON CHANNELS (Sold Separately)



Model: VBD-N0612-SD-B  
SKU: 666561432935



Model: VBD-N0612-SD-W  
SKU: 666561432980



Model: VBD-N1212-SF-B  
SKU: 666561432683



Model: VBD-N1212-SF-W  
SKU: 666561432737



Model: VBD-N2020-SFD-W  
SKU: 666561432881

For more information about our products and services, please visit our website: [www.veroboard.com](http://www.veroboard.com)