

# VEROBOARD®

## Model: VBD-N1010-SF-B

Material:	Silicone
Colour:	Black
Beam Angel:	120°
Channel Length:	10m (32.8ft) Max
Channel Width:	10mm (0.39")
Channel Height:	10mm (0.39")

Job Name: \_\_\_\_\_

Distributor: \_\_\_\_\_

Type: \_\_\_\_\_

VBD-N1010-SF-B (5 meters)

**SKU: 666561432621**



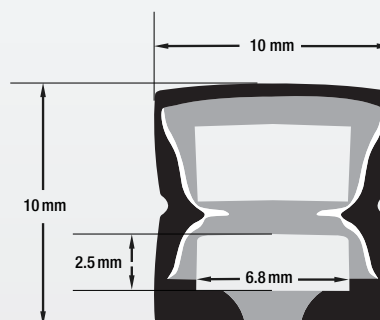

Model: VBD-N1010-SF-B

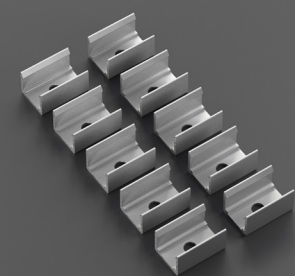
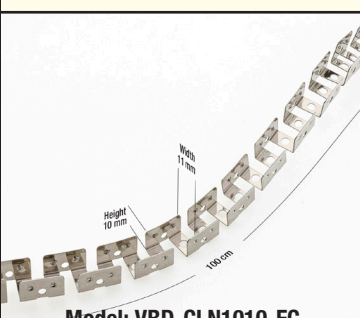

**VBD-N1010-SF-B** is designed to meet your needs with exceptional performance and quality. Please note that while this product is built to excel in various conditions, it is not recommended for extended exposure to strong UV rays or direct sunlight. If you intend to utilize the **VBD-N1010-SF-B** outdoors, we strongly recommend providing ample shade or protective cover to shield it from direct sunlight.

## ACCESSORIES (Sold Separately)

End Caps (1 Pair/bag)	Mounting Clips (10 PCs/bag)	Flexible Clips (1 Meter)	Linear Mounting (1 Meter)
 <p>Model: VBD-EN1010-B SKU: 666561432638</p>	 <p>Model: VBD-CLN1010-MC SKU: 666561432669</p>	 <p>Model: VBD-CLN1010-FC SKU: 666561432645</p>	 <p>Model: VBD-CLN1010-LI SKU: 666561432652</p>

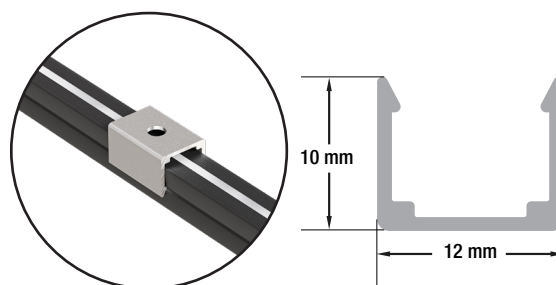

# VEROBOARD®

**LED Type:** VBDFS-E2835-XXXX-168-24-NS-6  
**Colour:** 2700K • 3000K • 3500K • 4000K • 5000K  
 RED • GREEN • BLUE • YELLOW

	Wattage	Brightness
Per Foot	3.5W/ft	450Lm/ft
Per Meter	12W/m	1475Lm/m



## DESCRIPTION

Flexible 6mm-wide linear LED strip, specially designed for our Flexible Neon Channels, does not include double-sided 3m tape so that it can be easily inserted into the neon channel. can be cut every 7 LEDs (42mm or 1.63 inches). These LED strip lights are crafted from premium materials and engineered for professional lighting applications. Each strip light starts with a robust dual-core copper printed circuit board (PCB), which is then fitted with an array of chips and color options through soldering.

## DIMENSIONS

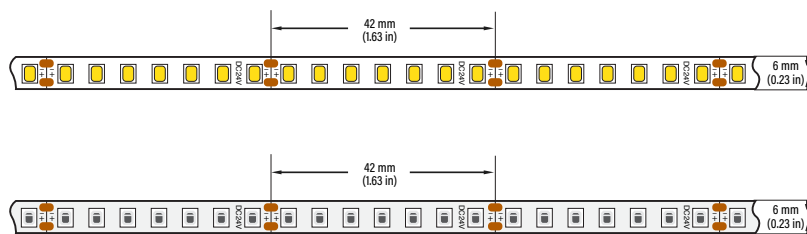

## SPECIFICATIONS

<b>Model:</b>	VBDFS-E2835-xxxx-168-24-NS-6
<b>Color Temperature:</b>	2700K • 3000K • 3500K • 4000K • 5000K Red • Green • Blue • Yellow
<b>LED Type:</b>	2835 SMD
<b>LED Qty:</b>	168 LEDs per meter
<b>Input Voltage (VF):</b>	24V DC
<b>Power:</b>	12W per meter (3.5W/ft)
<b>Brightness:</b>	1475 Lm/meter (450 Lm/ft)
<b>Lifespan:</b>	>50,000 hours
<b>PCB:</b>	4oz PCB, Double-side, white colour 6mm width
<b>Rendering Index (Ra):</b>	CRI>95
<b>Beam Angle:</b>	120°
<b>Dimmable:</b>	Yes
<b>Cut Size:</b>	Every 7 LED chips (1.63")
<b>Operating Temperature:</b>	-15°C to +40°C
<b>Dimensions:</b>	6mm (0.23")
<b>Certificates:</b>	UL / RoHs

**COMPATIBLE  
 SILICONE NEON  
 CHANNELS**  
 (Sold Separately)



Model: VBD-N1010-SF-B  
 SKU: 666561432621



Model: VBD-N1010-SF-W  
 SKU: 666561432676



Model: VBD-N0410-SD-W  
 SKU: 666561432614

Job Name: \_\_\_\_\_

Distributor: \_\_\_\_\_

Type: \_\_\_\_\_

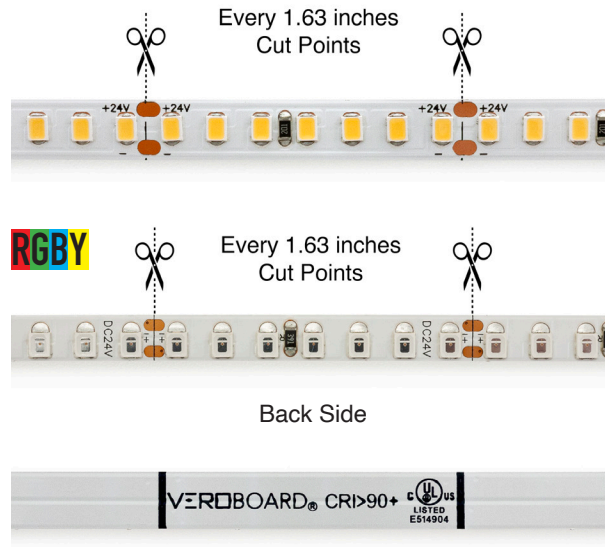

For more information about our products and services, please visit our website: [www.veroboard.com](http://www.veroboard.com)