

# VEROBOARD®

## 3" Trimless Gimbal

Veroboard 3 inches trimless downlight is specially designed to eliminate glare when illuminated. It is an IC-rated fixture that comes along with a junction box LED driver. It has the option of choosing desired color temperature from 2700K-3000K-3500K-4000K-5000K. This light is perfect for both new construction and remodeling installation with easy push spring clips.

### SPECIFICATIONS



<b>Engine Model No:</b>	LED-3-S8W-L5CCTWH-T
<b>Voltage:</b>	120V AC
<b>Wattage:</b>	8W
<b>LED Driver:</b>	IC Rated
<b>Color Temperature:</b>	5CCT Selectable Color Temperature (2700K-3000K-3500K-4000K-5000K)
<b>Dimmable:</b>	Yes
<b>Dimming:</b>	100 - 10% (Triac Dimming)
<b>Dimmers:</b>	LED/CEL Dimmers
<b>Brightness:</b>	600 Lumens
<b>Rendering Index:</b>	CRI>90
<b>LED Type:</b>	Integrated COB LED
<b>Fixture Color:</b>	White
<b>Fixture Material:</b>	Die-Cast Aluminum
<b>Rated Life:</b>	50,000 Hours
<b>Installation:</b>	Recessed/Flush Mount
<b>IP Rating:</b>	IP20 (Damp Locations)
<b>Outer Dimensions:</b>	Ø75 x 63.12 mm Depth (Ø2.95 x 2.48 in)
<b>LED Driver Dimensions:</b>	103 x 52.30 mm (4 x 2 in)
<b>Cut Size:</b>	78 mm (3.25 in)
<b>Package Content:</b>	Light Fixture with IC-Rated LED Driver
<b>Certification:</b>	FCC/ETL/Energy Star/RoHS



Selectable  
Color Temperature  
Switch



**LED DRIVER  
INCLUDED**

#### Disclaimer:

The data and information contained in this specification sheet are subject to change without notice; the ratings supplied are provided based on the product manufacturer. The information contained in this specification sheet should not be considered a warranty, expressed or implied, including, but not limited to, a warranty of merchantability or fitness for a particular purpose. In no event shall Veroboard be liable for any incidental or consequential damages resulting from the use, misuse, or inability to use the product. This exclusion applies regardless of whether such damages are sought based on breach of warranty, breach of contract, negligence, strict liability in tort, or any other legal theory.

Name: \_\_\_\_\_

Quantity: \_\_\_\_\_

Phone: \_\_\_\_\_

Email: \_\_\_\_\_

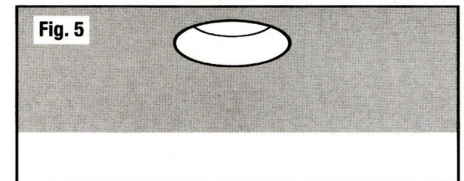
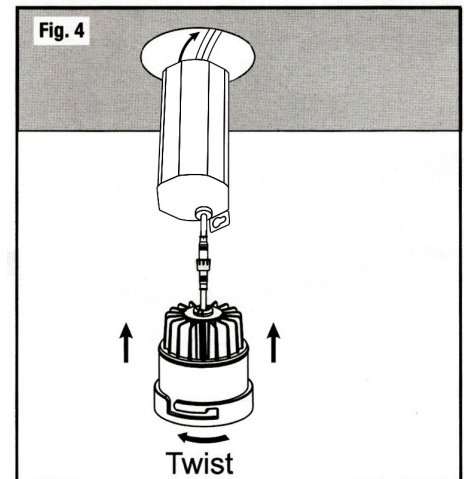
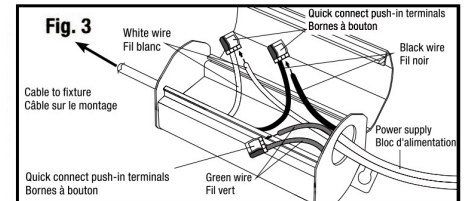
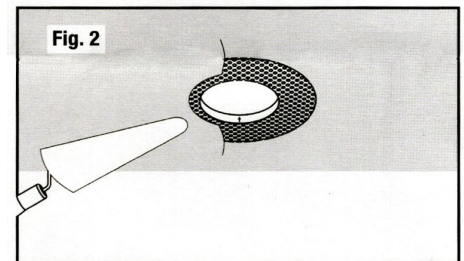
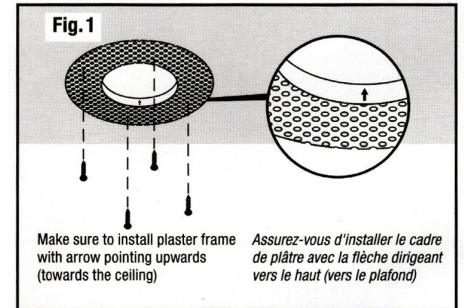

SKU: 666561425692

# Light Measurement Report

Print date: 2023-01-06

Measurement date and time: 2023-01-06 2:58:45 PM – Measurement no. VFR-230106-0057-MS

## Luminous Intensity diagram

Unit: 0-100% of peak intensity

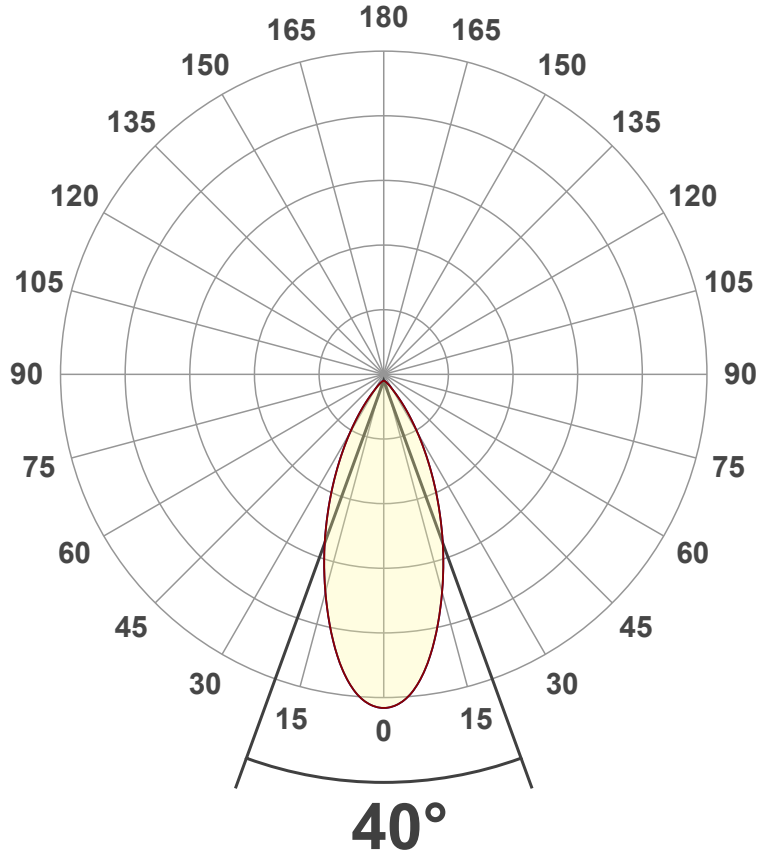

## Main Values

Output (total Lumen)	600 lm
Lumen Up% / Down%	0% / 100%
Peak Intensity	962 cd
Beam Angle (50%)	40°
Beam Angle (90%)	42.6°
Beam Angle (10%)	42.6°

## Cut-off Angle

Average 2,5%	100°
--------------	------

## Field Angle

Average 10%	78.2°
-------------	-------

## Intensity Ratio

In 120° cone	98.2%
In 90° cone	93.8%

**C000-C180**  
**C090-C270**

## Linear distribution diagram - Intensity (candela) vs $\gamma$ -angle

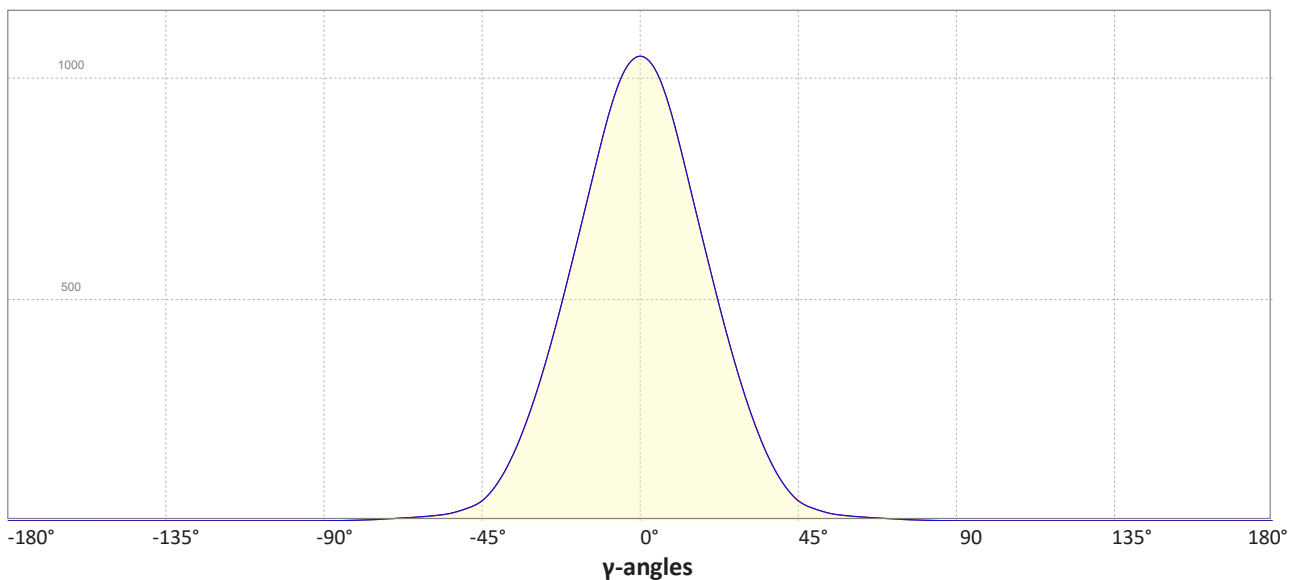

# Light Measurement Report

Print date: 2023-01-06

Measurement date and time: 2023-01-06 2:58:45 PM – Measurement no. VFR-230106-0057-MS

## Color details

Correlated Color Temperature, Target CCT = 3000 K  
 Correlated Color Temperature, Measured CCT = 2877 K  
 Color Rendering Index CRI 92.8  
 Color Rendering Index, R9 (red component) R9 = 56.9  
 Color Rendering TM30-18 R<sub>f</sub> 88.7 – R<sub>g</sub> 93.9  
 Color Quality Scale CQS = 89.9

MacAdam Steps  
 Color coordinates CIE 1931 (x;y) = (0.437;0.404)  
 Color coordinate CIEs 1960 (u';v') = (0.251;0.348)  
 Color deviation from BBL Duv = 0.0024  
 Color coordinate CIEs 1976 (CIELUV) (u'';v'') = (0.251;0.251)

CIE 1931

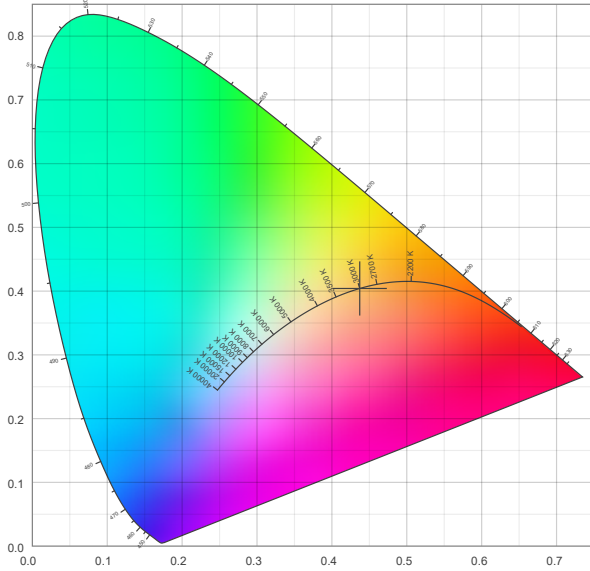

CIE 1931 – zoomed on Planckian locus

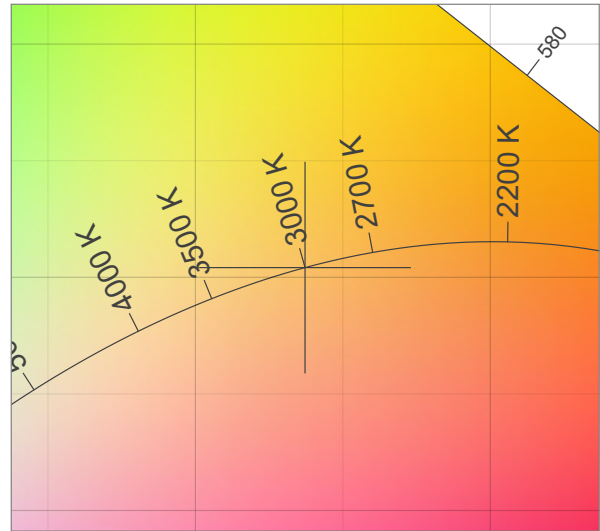

Color Rendering Index per reference color (CIE 1995)

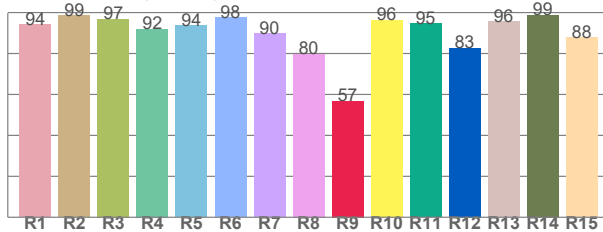

CRI R values, only R1-R8 are used to calculate final CRI value

R1	R2	R3	R4	R5	R6	R7	R8	R9	R10	R11	R12	R13	R14	R15
94.1	98.6	96.8	92.1	93.7	97.6	89.7	79.8	56.9	96.3	94.6	82.6	95.6	98.8	87.9

Spectral power distribution (SPD) / W/nm – 0-100%

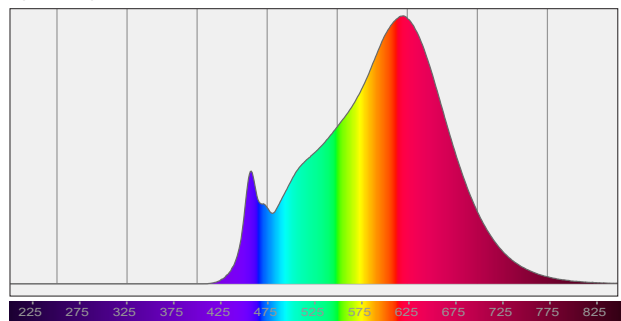

TM30-18 Rf-values per hue bin

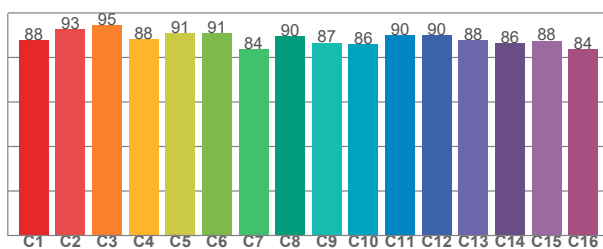

TM30 C values, 16 binned values out of total of 99 C values

C1	C2	C3	C4	C5	C6	C7	C8	C9	C10	C11	C12	C13	C14	C15	C16
87.7	92.6	94.6	88.3	90.8	90.8	83.7	89.6	86.6	85.9	89.9	90.0	87.8	86.3	87.6	83.6

Color Quality Scale by reference color

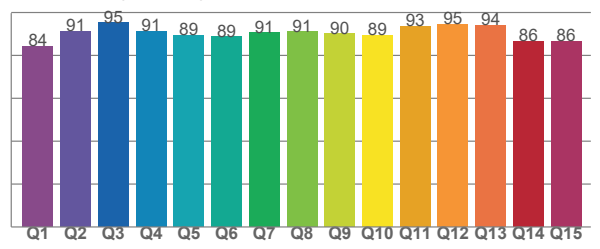

CQS Q values

Q1	Q2	Q3	Q4	Q5	Q6	Q7	Q8	Q9	Q10	Q11	Q12	Q13	Q14	Q15
84.3	91.4	95.3	91.3	89.5	88.7	90.5	91.0	90.2	89.3	93.4	94.6	94.0	86.5	86.5

# Light Measurement Report

Print date: 2023-01-06

Measurement date and time: 2023-01-06 2:58:45 PM – Measurement no. VFR-230106-0057-MS

## Beam Details

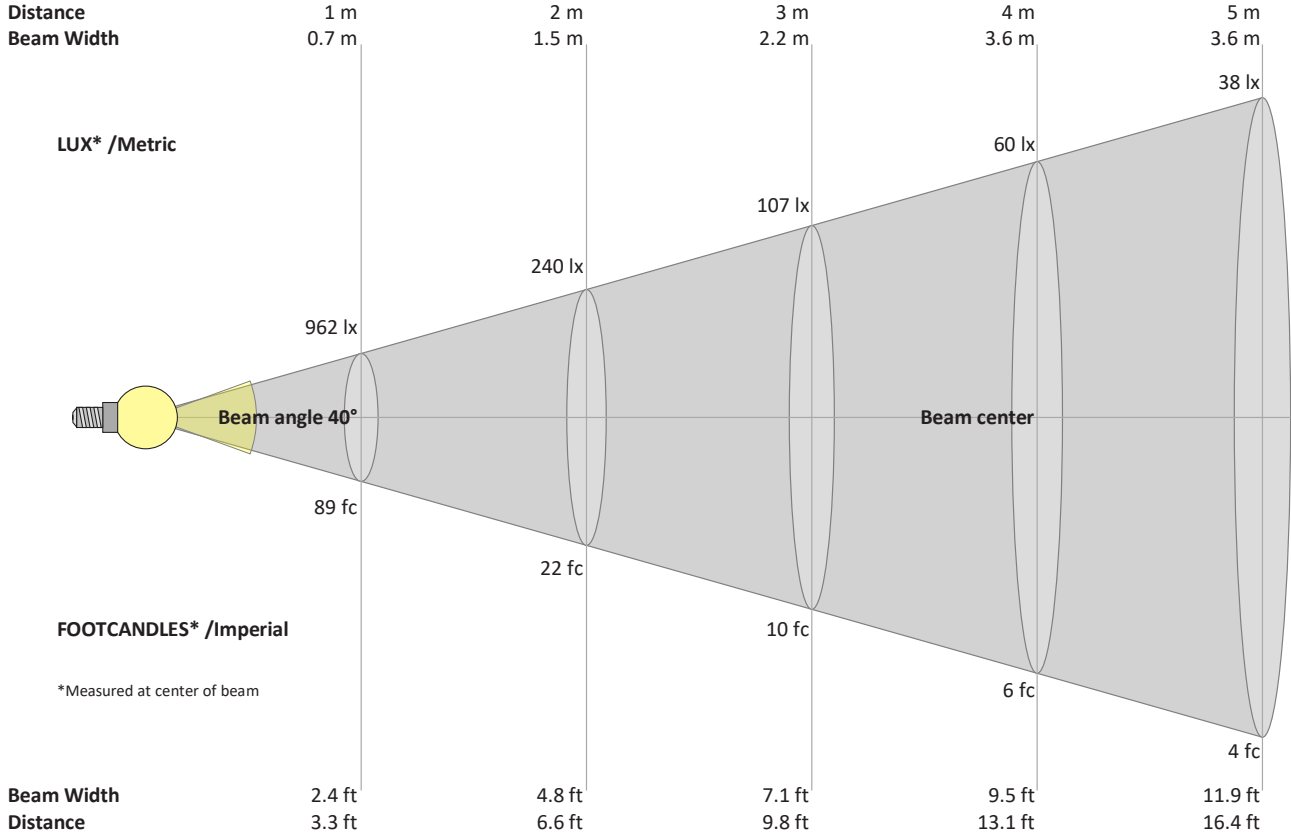

### Beam intensities from 1 – 20 m

1	2	3	4	5	6	7	8	9	10	11	12	13	14	15	16	17	18	19	20	m
3.3	6.6	9.8	13.1	16.4	19.7	23	26.2	29.5	32.8	36.1	39.4	42.7	45.9	49.2	52.5	55.8	59.1	62.3	65.6	ft
962	240	107	60	38	27	20	15	12	10	8	7	6	5	4	4	3	3	3	2	lux
89.3	22.3	9.9	5.6	3.6	2.5	1.8	1.4	1.1	0.9	0.7	0.6	0.5	0.5	0.4	0.3	0.3	0.3	0.2	0.2	fc

### Intensities in 0° c-plane

0°	2°	4°	6°	8°	10°	12°	14°	16°	18°	20°	22°	24°	26°	28°	30°	32°	34°	36°	38°	y
962	956	938	907	865	813	756	696	636	577	518	460	405	352	302	255	213	174	140	110	cd
100%	99%	98%	94%	90%	85%	79%	72%	66%	60%	54%	48%	42%	37%	31%	27%	22%	18%	15%	11%	of 0°val

### Intensities in 90° c-plane

0°	2°	4°	6°	8°	10°	12°	14°	16°	18°	20°	22°	24°	26°	28°	30°	32°	34°	36°	38°	y
962	956	938	907	865	813	756	696	636	577	518	460	405	352	302	255	213	174	140	110	cd
100%	99%	98%	94%	90%	85%	79%	72%	66%	60%	54%	48%	42%	37%	31%	27%	22%	18%	15%	11%	of 0°val

### Intensities in 180° c-plane

0°	2°	4°	6°	8°	10°	12°	14°	16°	18°	20°	22°	24°	26°	28°	30°	32°	34°	36°	38°	y
962	956	938	907	865	813	756	696	636	577	518	460	405	352	302	255	213	174	140	110	cd
100%	99%	98%	94%	90%	85%	79%	72%	66%	60%	54%	48%	42%	37%	31%	27%	22%	18%	15%	11%	of 0°val

### Intensities in 270° c-plane

0°	2°	4°	6°	8°	10°	12°	14°	16°	18°	20°	22°	24°	26°	28°	30°	32°	34°	36°	38°	y
962	956	938	907	865	813	756	696	636	577	518	460	405	352	302	255	213	174	140	110	cd
100%	99%	98%	94%	90%	85%	79%	72%	66%	60%	54%	48%	42%	37%	31%	27%	22%	18%	15%	11%	of 0°val