

VEROBOARD®

4" Gimbal Adjustable Downlight Canless



Veroboard 4-inch adjustable recessed gimbal has a 360-degree angle rotation that helps in rotating the luminaire in the needed direction. They come with an IC-rated LED driver. They come with zero flickers and with a rendering index of 90+. These lights have a feature of selecting the light color from five temperatures ranging from 2700K-3000K-3500K to 4000K-5000K. Moreover, they are compatible with most of the dimmers including DVCL-153P and DVCLP-300P dimmers.

SPECIFICATIONS

Engine Model No:	AD-LED-4-S12W-5CCTWH-EY
Voltage:	120V AC
Frequency:	60Hz
Power Factor (PF):	0.9
Wattage:	12W
LED Driver:	IC Rated
Color Temperature:	5CCT Selectable Color Temperature (2700K-3000K-3500K-4000K-5000K)
Angle Rotation:	360°
Gimbal Tilt Angle:	30°
Beam Angle:	40°
Dimmable:	Yes
Dimming:	100 - 5% (Triac Dimming)
Brightness:	1000 Lumens
Rendering Index:	CRI>90
LED Type:	Integrated COB LED
Fixture Color:	White
Fixture Material:	Die-Cast Aluminum
Rated Life:	50,000 Hours
Installation:	Recessed/Flush Mount
IP Rating:	IP20 (Damp Locations)
Cut Size:	108 mm (4.25 in)
Outer Dimensions:	Ø125 mm (Ø4.9 in) x 50.50 mm (2 in) Depth
LED Driver Dimensions:	90 x 80 x 35.5 mm (3.5 x 3.15 x 1.4 in)
Package Content:	Gimbal with IC-Rated LED Driver
Package Dimensions:	5.5 x 5.4 x 4 in (14.3 x 13.3 x 10.2 cm)
Package Weight:	0.712 Kg
Certification:	FCC/ETL/Energy Star/RoHS

Name: _____

Quantity: _____

Phone: _____

Email: _____



360° Rotation
30° Tilt

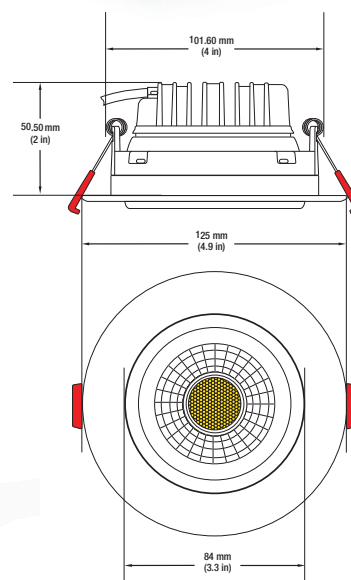

Selectable
Color Temperature
Switch

LED Driver Dimensions:
Length: 90 mm (3.5 in)
Width: 80 mm (3.15 in)
Depth: 35.5 mm (1.4 in)



Safety and Warning

The fixture must be wired in accordance with local electrical codes. And all the installation must be done by a certified electrician. Please be sure the main power switch is OFF before the installation or attempting any maintenance. This product may cause interference with radio equipment and should not be installed near maritime safety communications equipment or other critical navigation or communication equipment operating between 0.45-30MHz.

Read all the instructions from the installation manual before installing. This product is suitable for dry and damp locations only.



SKU: 666561425135

Light Measurement Report

Print date: 2023-01-10

Measurement date and time: 2023-01-10 3:10:49 PM – Measurement no. VFR-230110-0098-MS

Luminous Intensity diagram

Unit: 0-100% of peak intensity

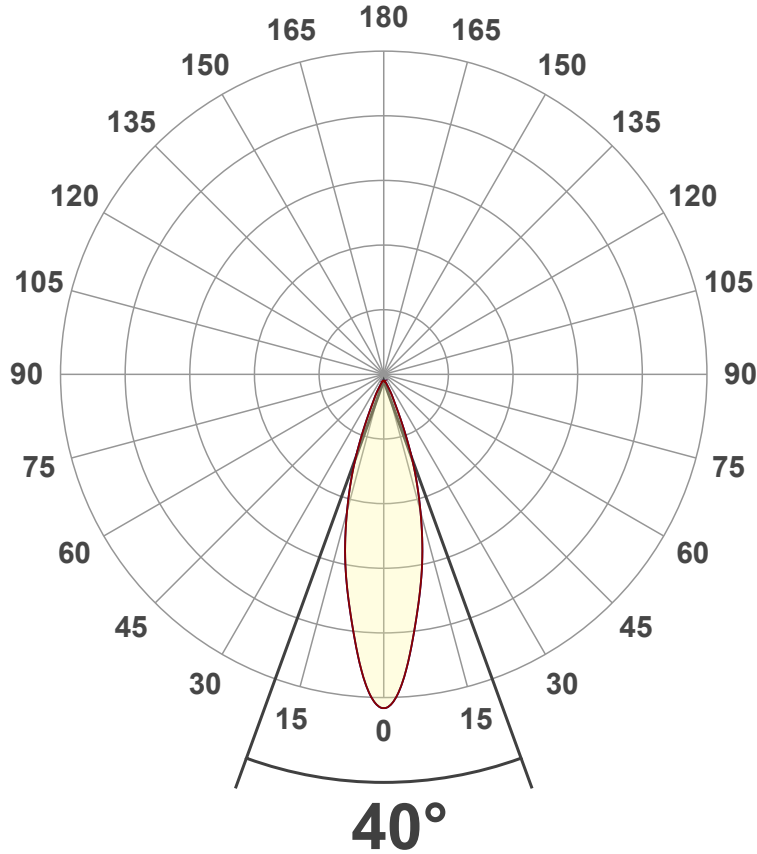

Main Values

Output (total Lumen)	1000 lm
Lumen Up% / Down%	0% / 100%
Peak Intensity	3423 cd
Beam Angle (50%)	40°
Beam Angle (90%)	27.7°
Beam Angle (10%)	27.7°

Cut-off Angle

Average 2,5%	70.6°
--------------	-------

Field Angle

Average 10%	50.8°
-------------	-------

Intensity Ratio

In 120° cone	97.9%
In 90° cone	94.6%

C000-C180

C090-C270

Linear distribution diagram - Intensity (candela) vs γ -angle

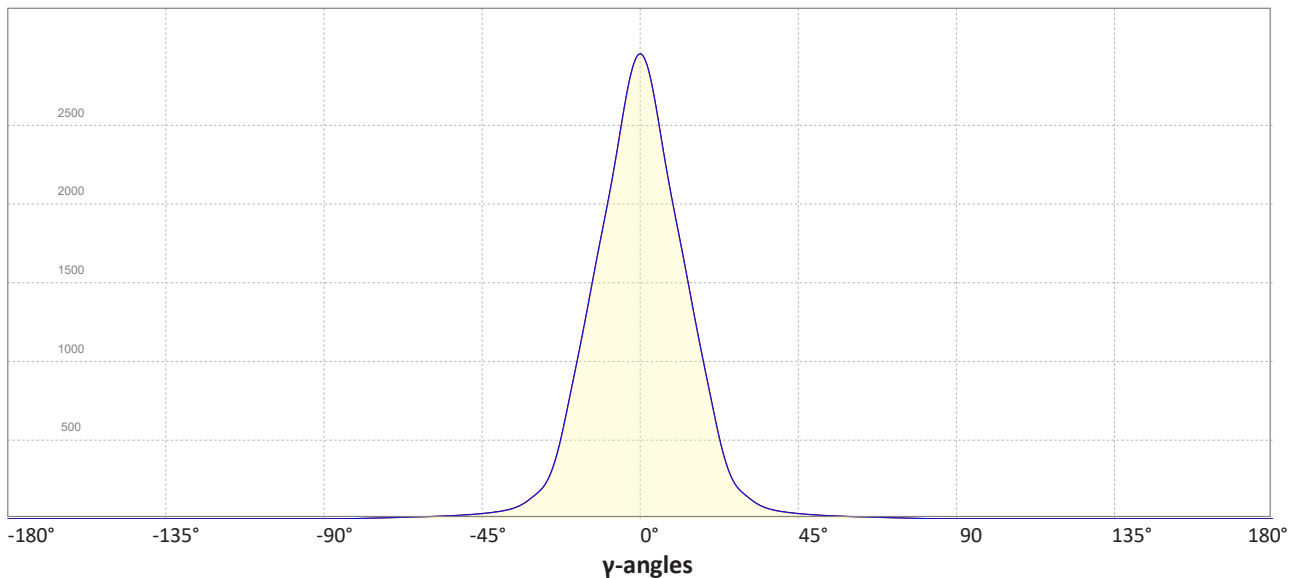

Light Measurement Report

Print date: 2023-01-10

Measurement date and time: 2023-01-10 3:10:49 PM – Measurement no. VFR-230110-0098-MS

Color details

Correlated Color Temperature, Target CCT = 3000 K
 Correlated Color Temperature, Measured CCT = 2886 K
 Color Rendering Index CRI 92.7
 Color Rendering Index, R9 (red component) R9 = 56.8
 Color Rendering TM30-18 R_f 88.5 – R_g 93.8
 Color Quality Scale CQS = 89.8

MacAdam Steps
 Color coordinates CIE 1931 (x;y) = (0.437;0.404)
 Color coordinate CIEs 1960 (u';v') = (0.251;0.348)
 Color deviation from BBL Duv = 0.0023
 Color coordinate CIEs 1976 (CIELUV) (u'';v'') = (0.251;0.251)

CIE 1931



CIE 1931 – zoomed on Planckian locus



Color Rendering Index per reference color (CIE 1995)

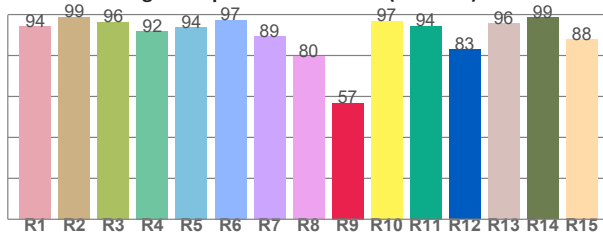

CRI R values, only R1-R8 are used to calculate final CRI value

R1	R2	R3	R4	R5	R6	R7	R8	R9	R10	R11	R12	R13	R14	R15
94.2	98.8	96.3	91.9	93.8	97.3	89.4	79.6	56.8	96.9	94.4	83.0	95.8	98.6	87.9

Spectral power distribution (SPD) / W/nm – 0-100%

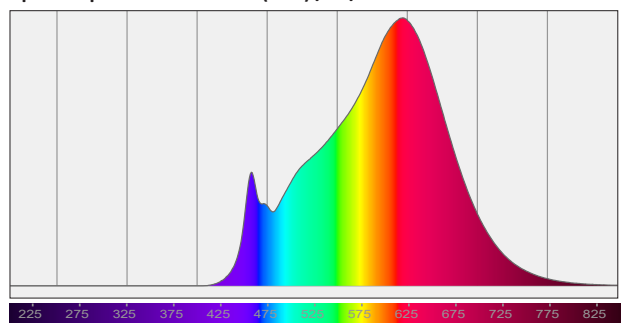

TM30-18 Rf-values per hue bin

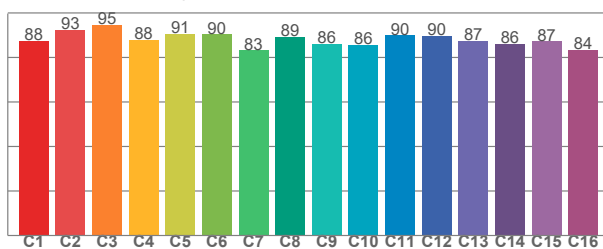

TM30 C values, 16 binned values out of total of 99 C values

C1	C2	C3	C4	C5	C6	C7	C8	C9	C10	C11	C12	C13	C14	C15	C16
87.5	92.5	94.6	88.0	90.6	90.5	83.3	89.3	86.3	85.8	90.0	89.8	87.5	86.1	87.4	83.5

Color Quality Scale by reference color

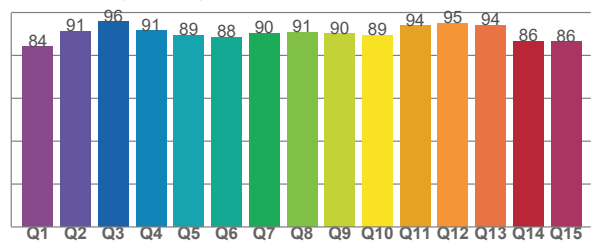

CQS Q values

Q1	Q2	Q3	Q4	Q5	Q6	Q7	Q8	Q9	Q10	Q11	Q12	Q13	Q14	Q15
84.1	91.1	95.6	91.4	89.3	88.3	90.2	90.8	90.1	89.5	93.8	94.8	94.0	86.5	86.4

Light Measurement Report

Print date: 2023-01-10

Measurement date and time: 2023-01-10 3:10:49 PM – Measurement no. VFR-230110-0098-MS

Beam Details

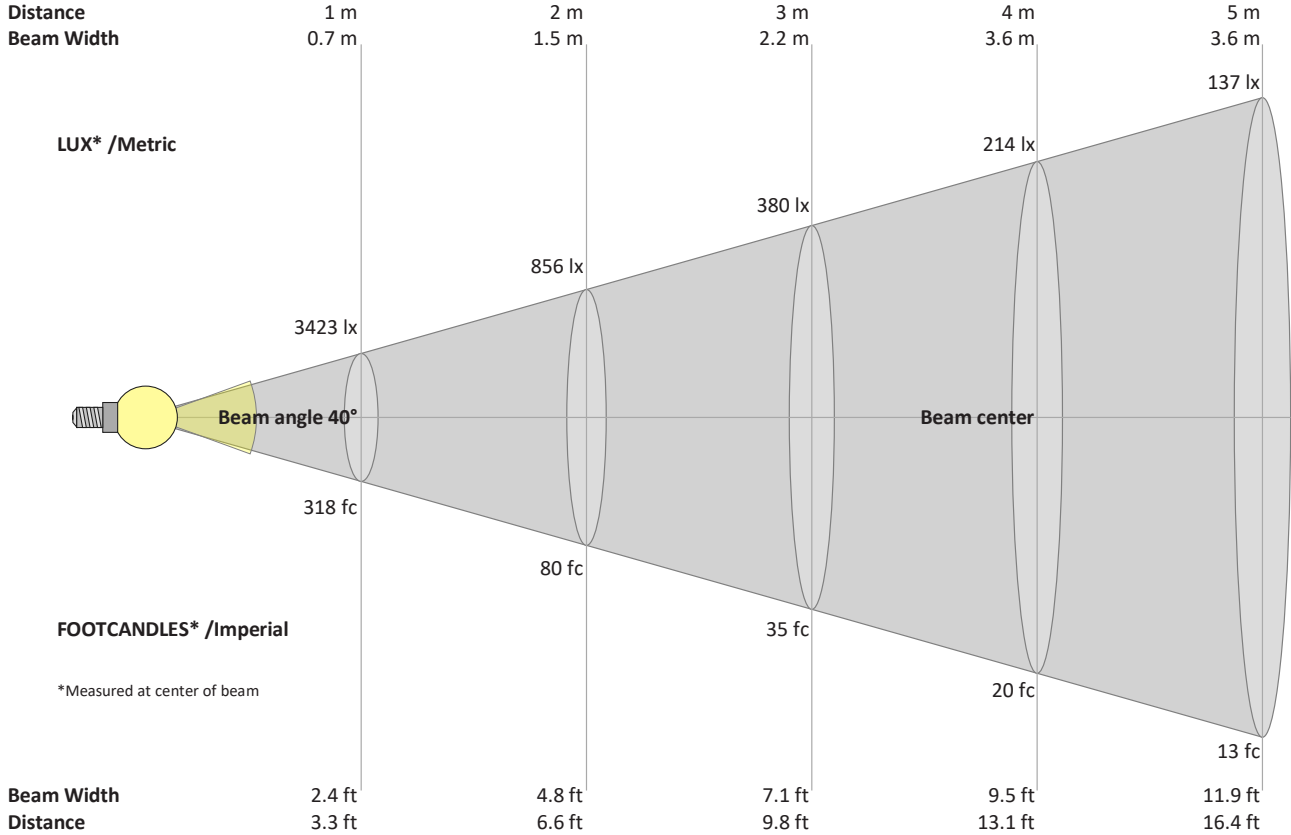

Beam intensities from 1 – 20 m

1	2	3	4	5	6	7	8	9	10	11	12	13	14	15	16	17	18	19	20	m
3.3	6.6	9.8	13.1	16.4	19.7	23	26.2	29.5	32.8	36.1	39.4	42.7	45.9	49.2	52.5	55.8	59.1	62.3	65.6	ft
3423	856	380	214	137	95	70	53	42	34	28	24	20	17	15	13	12	11	9	9	lux
318	79.5	35.3	19.9	12.7	8.8	6.5	5	3.9	3.2	2.6	2.2	1.9	1.6	1.4	1.2	1.1	1	0.9	0.8	fc

Intensities in 0° c-plane

0°	2°	4°	6°	8°	10°	12°	14°	16°	18°	20°	22°	24°	26°	28°	30°	32°	34°	36°	38°	y
3423	3337	3108	2805	2503	2229	1965	1692	1418	1158	906	659	451	306	223	174	134	101	79	65	cd
100%	97%	91%	82%	73%	65%	57%	49%	41%	34%	26%	19%	13%	9%	7%	5%	4%	3%	2%	2%	of 0°val

Intensities in 90° c-plane

0°	2°	4°	6°	8°	10°	12°	14°	16°	18°	20°	22°	24°	26°	28°	30°	32°	34°	36°	38°	y
3423	3337	3108	2805	2503	2229	1965	1692	1418	1158	906	659	451	306	223	174	134	101	79	65	cd
100%	97%	91%	82%	73%	65%	57%	49%	41%	34%	26%	19%	13%	9%	7%	5%	4%	3%	2%	2%	of 0°val

Intensities in 180° c-plane

0°	2°	4°	6°	8°	10°	12°	14°	16°	18°	20°	22°	24°	26°	28°	30°	32°	34°	36°	38°	y
3423	3337	3108	2805	2503	2229	1965	1692	1418	1158	906	659	451	306	223	174	134	101	79	65	cd
100%	97%	91%	82%	73%	65%	57%	49%	41%	34%	26%	19%	13%	9%	7%	5%	4%	3%	2%	2%	of 0°val

Intensities in 270° c-plane

0°	2°	4°	6°	8°	10°	12°	14°	16°	18°	20°	22°	24°	26°	28°	30°	32°	34°	36°	38°	y
3423	3337	3108	2805	2503	2229	1965	1692	1418	1158	906	659	451	306	223	174	134	101	79	65	cd
100%	97%	91%	82%	73%	65%	57%	49%	41%	34%	26%	19%	13%	9%	7%	5%	4%	3%	2%	2%	of 0°val