

4" Flat LED Panel Light

Name: _____

Company: _____

Phone: _____

Email: _____

SPECIFICATIONS



Model No.	Z4C-9
Input Voltage	120V AC
Wattage	9W
Frequency	50/60Hz
Colour Temperatures	3CCT Selectable Colour Temperatures (3000K-4000K-5000K)
Available Trim Colour	Black, Brushed Nickel
Brightness	589-673 Lumens
Beam Angle	110°
Dimming	100 – 10% (Triac Dimming)
Rendering Index	CRI>90
IP Rating	IP20 (Indoor use only)
Location Approved	Damp Location
Certifications	ETL/cUL/Energy Star

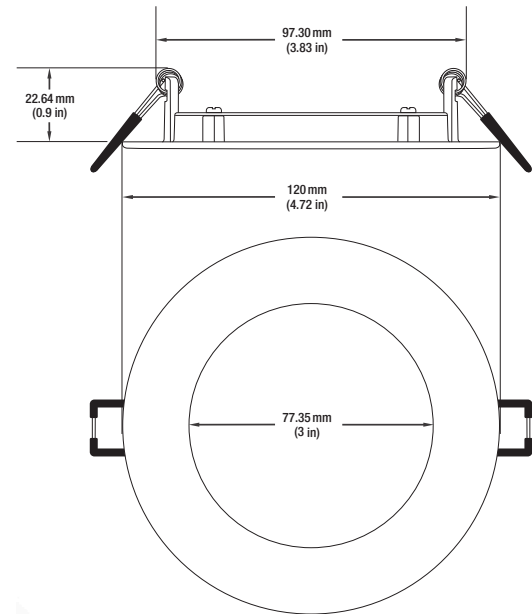

FEATURES



- This downlight works in various indoor applications. It has universal ceiling applications.
- Recessed lighting is suitable for both dry and damp environments with its Ingress Protection rating of IP20.
- The temperature of the light can be adjusted to the desired application from the junction box DIP switch.
- Selectable color Temperature option 3000K-4000K-5000K from the junction box.
- No additional LED driver is needed.
- Trim is available in different Colors (White, Black, Brushed Nickel).
- Well suited for both residential and commercial indoor spaces.



Available Trim Colour
(Sold Separately)

Z4C-9-BK
SKU: 666561415242

Z4C-9-BN
SKU: 666561415259

3CCT
SELECTABLE
Brightness
589~673
lumens



**LED DRIVER
INCLUDED**

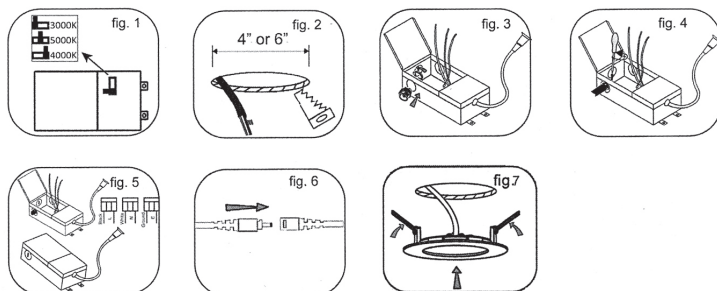

Disclaimer:

The data and information contained in this specification sheet are subject to change without notice; the ratings supplied are provided based on the product manufacturer. The information contained in this specification sheet should not be considered a warranty, expressed or implied, including, but not limited to, a warranty of merchantability or fitness for a particular purpose. In no event shall Veroboard be liable for any incidental or consequential damages resulting from the use, misuse, or inability to use the product. This exclusion applies regardless of whether such damages are sought based on breach of warranty, breach of contract, negligence, strict liability in tort, or any other legal theory.



SKU: 666561415228

Light Measurement Report

Print date: 2023-01-06

Measurement date and time: 2023-01-06 9:57:34 AM – Measurement no. VFR-230106-0048-MS

Luminous Intensity diagram

Unit: 0-100% of peak intensity

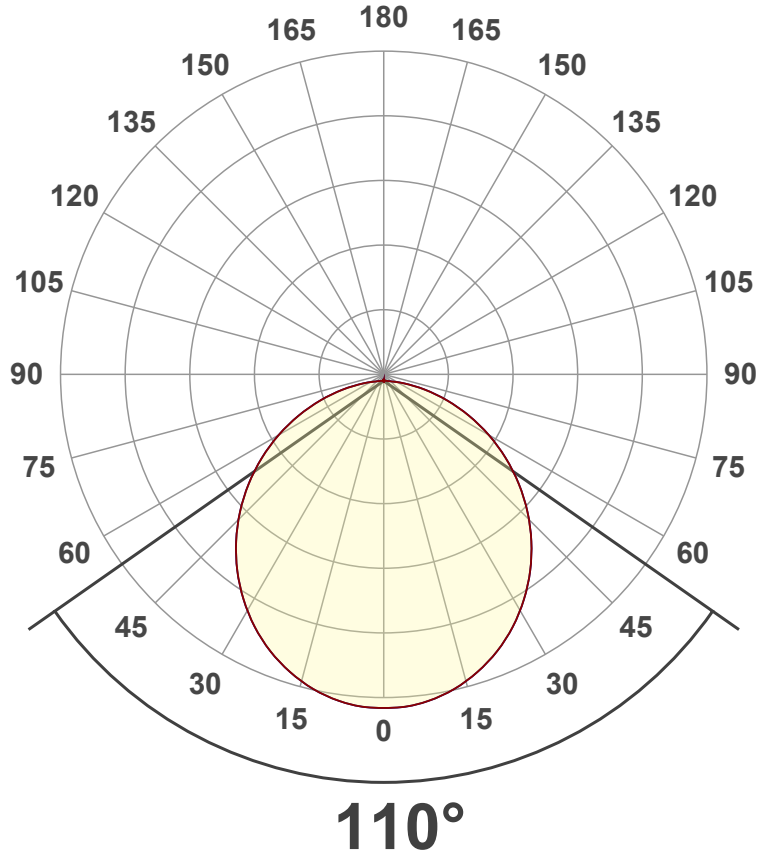

Main Values

Output (total Lumen)	605 lm
Lumen Up% / Down%	0.06% / 99.94%
Peak Intensity	218 cd
Beam Angle (50%)	110°
Beam Angle (90%)	109.5°
Beam Angle (10%)	109.5°

Cut-off Angle

Average 2,5%	173.7°
--------------	--------

Field Angle

Average 10%	160.9°
-------------	--------

Intensity Ratio

In 120° cone	79.4%
In 90° cone	54.5%

C000-C180
C090-C270

Linear distribution diagram - Intensity (candela) vs γ -angle

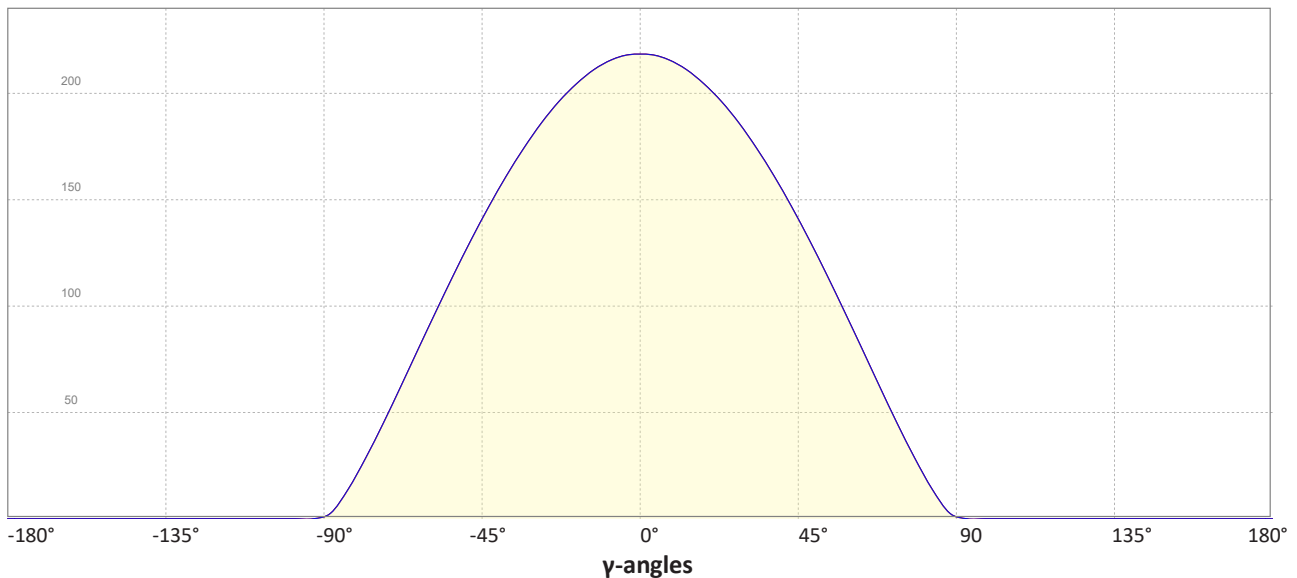

Light Measurement Report

Print date: 2023-01-06

Measurement date and time: 2023-01-06 9:57:34 AM – Measurement no. VFR-230106-0048-MS

Color details

Correlated Color Temperature, Target CCT = 3000 K
 Correlated Color Temperature, Measured CCT = 2934 K
 Color Rendering Index CRI 92.3
 Color Rendering Index, R9 (red component) R9 = 51.5
 Color Rendering TM30-18 R_f 91.2 – R_g 101.0
 Color Quality Scale CQS = 89.7

MacAdam Steps SDCM = 3.1
 Color coordinates CIE 1931 (x;y) = (0.437;0.404)
 Color coordinate CIEs 1960 (u';v') = (0.251;0.348)
 Color deviation from BBL Duv = -0.0025
 Color coordinate CIEs 1976 (CIELUV) (u'';v'') = (0.251;0.251)

CIE 1931

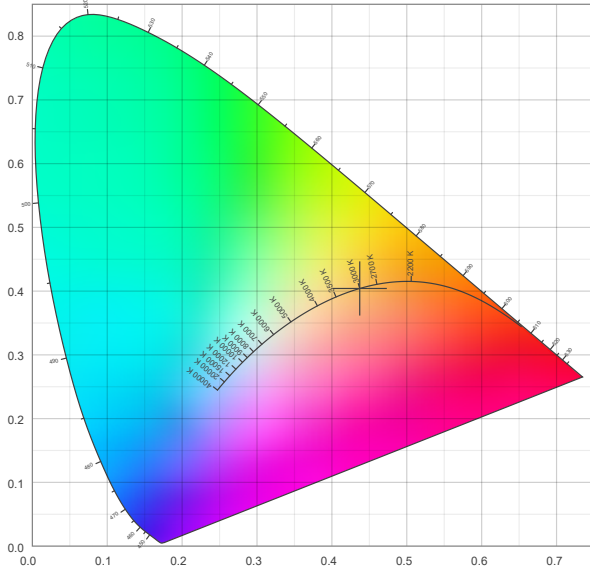

CIE 1931 – zoomed on Planckian locus



Color Rendering Index per reference color (CIE 1995)

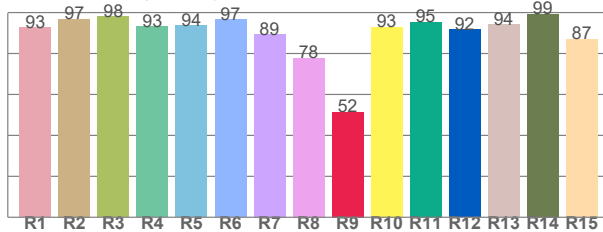

CRI R values, only R1-R8 are used to calculate final CRI value

R1	R2	R3	R4	R5	R6	R7	R8	R9	R10	R11	R12	R13	R14	R15
92.8	96.8	98.0	93.2	93.6	96.6	89.4	77.9	51.5	93.0	95.4	91.7	94.1	99.4	87.2

Spectral power distribution (SPD) / W/nm – 0-100%

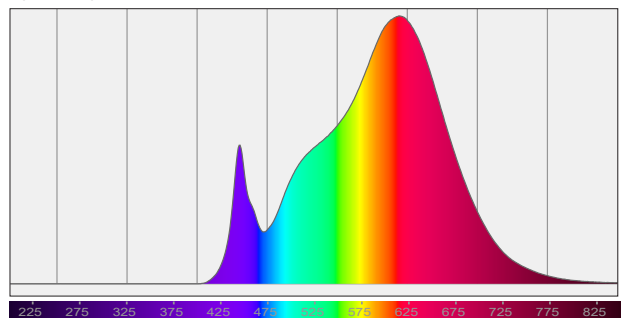

TM30-18 Rf-values per hue bin

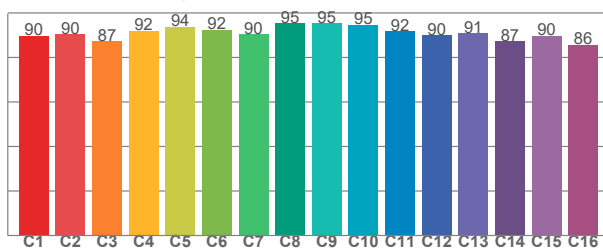

TM30 C values, 16 binned values out of total of 99 C values

C1	C2	C3	C4	C5	C6	C7	C8	C9	C10	C11	C12	C13	C14	C15	C16
89.7	90.4	87.3	91.9	93.7	92.5	90.5	95.3	95.5	94.7	91.9	89.9	90.8	87.3	89.8	85.8

Color Quality Scale by reference color

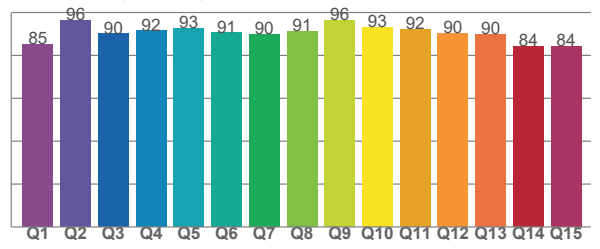

CQS Q values

Q1	Q2	Q3	Q4	Q5	Q6	Q7	Q8	Q9	Q10	Q11	Q12	Q13	Q14	Q15
85.2	96.3	90.1	91.5	92.5	90.5	89.7	91.2	96.4	93.2	92.2	90.4	90.0	84.2	84.3

Light Measurement Report

Print date: 2023-01-06

Measurement date and time: 2023-01-06 9:57:34 AM – Measurement no. VFR-230106-0048-MS

Beam Details

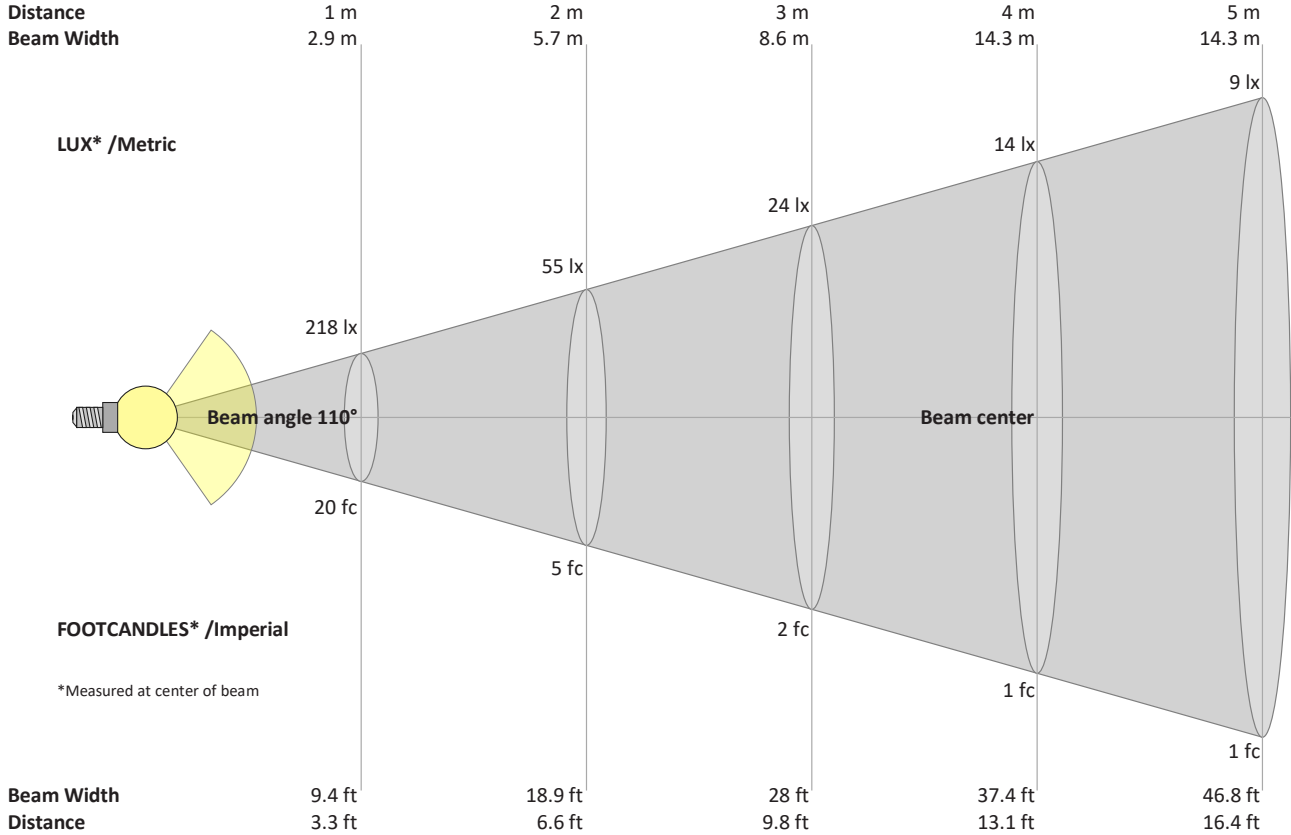

Beam intensities from 1 – 20 m

1	2	3	4	5	6	7	8	9	10	11	12	13	14	15	16	17	18	19	20	m	
3.3	6.6	9.8	13.1	16.4	19.7	23	26.2	29.5	32.8	36.1	39.4	42.7	45.9	49.2	52.5	55.8	59.1	62.3	65.6	ft	
218	55	24	14	9	6	4	3	3	2	2	2	1	1	1	1	1	1	1	1	1	lux
20.3	5.1	2.3	1.3	0.8	0.6	0.4	0.3	0.3	0.2	0.2	0.1	0.1	0.1	0.1	0.1	0.1	0.1	0.1	0.1	0.1	fc

Intensities in 0° c-plane

0°	5°	10°	15°	20°	25°	30°	35°	40°	45°	50°	55°	60°	65°	70°	75°	80°	85°	90°	95°	y
218	217	214	209	202	193	182	169	156	141	125	108	91	73	56	39	23	10	2	0	cd
100%	100%	98%	96%	92%	88%	83%	78%	71%	65%	57%	50%	42%	34%	26%	18%	11%	4%	1%	0%	of 0°val

Intensities in 90° c-plane

0°	5°	10°	15°	20°	25°	30°	35°	40°	45°	50°	55°	60°	65°	70°	75°	80°	85°	90°	95°	y
218	217	214	209	202	193	182	169	156	141	125	108	91	73	56	39	23	10	2	0	cd
100%	100%	98%	96%	92%	88%	83%	78%	71%	65%	57%	50%	42%	34%	26%	18%	11%	4%	1%	0%	of 0°val

Intensities in 180° c-plane

0°	5°	10°	15°	20°	25°	30°	35°	40°	45°	50°	55°	60°	65°	70°	75°	80°	85°	90°	95°	y
218	217	214	209	202	193	182	169	156	141	125	108	91	73	56	39	23	10	2	0	cd
100%	100%	98%	96%	92%	88%	83%	78%	71%	65%	57%	50%	42%	34%	26%	18%	11%	4%	1%	0%	of 0°val

Intensities in 270° c-plane

0°	5°	10°	15°	20°	25°	30°	35°	40°	45°	50°	55°	60°	65°	70°	75°	80°	85°	90°	95°	y
218	217	214	209	202	193	182	169	156	141	125	108	91	73	56	39	23	10	2	0	cd
100%	100%	98%	96%	92%	88%	83%	78%	71%	65%	57%	50%	42%	34%	26%	18%	11%	4%	1%	0%	of 0°val