

Name: \_\_\_\_\_

Company: \_\_\_\_\_

Phone: \_\_\_\_\_

Email: \_\_\_\_\_

## VBD-MTR-7C Light Fixture 2.5" Round Recessed Downlight

### SPECIFICATIONS



Model No.	VBD-MTR-7C
Trim Color	Polished Chrome
Trim Material	Aluminum
Trim Shape	Round
Compatible Light Engines	VBD-TR5-W (2400K • 2700K • 3000K • 3500K • 4000K • 5000K) VBD-TR4-RGBW
Outer Diameter	97.60mm (3.84")
Cut Size	65mm (2.5")
Depth	16.59mm (0.65")

SKU: 666561407247

### Features

- Widely used by interior designers.
- This VBD-MTR-7C light fixture is compatible to work with our VBD-TR Series Light engines.
- Contact us for more assistance and to know more about bulk orders.

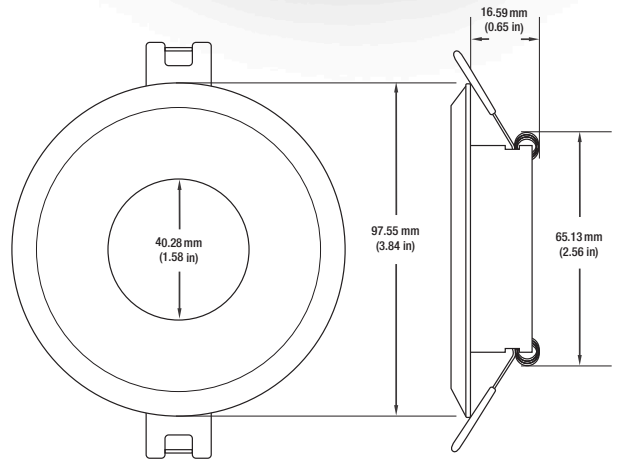

### VBD-TR5-W (Frosted Glass)

Model No.	VBD-TR5-W-FG
Input Voltage	12V DC
Wattage	5W
Body Colour	Metallic Silver
Available Trim Color	Silver • White • Black • Gold
Diffuser Material	Frosted Glass
Fixture Material	Aluminum
Beam Angle	110°
Rendering Index	CRI>90
IP Rating	IP20 (Damp Location)
Dimensions	49mm x 28.5mm (1.93" x 1.12")

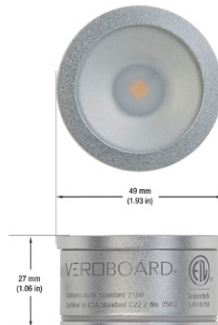

#### Beam Details

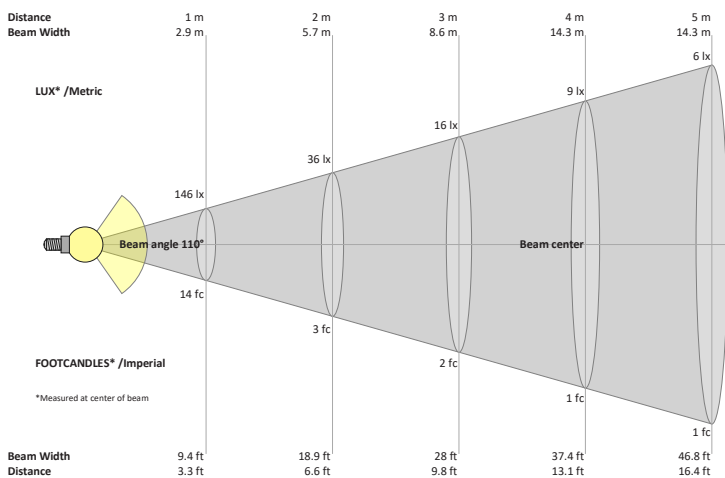

#### Available Colour Temperatures

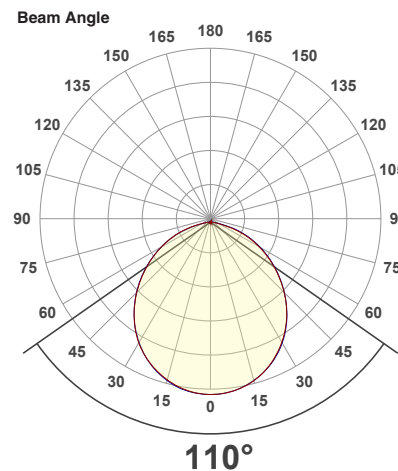

### ORDERING GUIDE

Example part number: **VBD-TR5-W-FG-24K-S**

MODEL	SERIES	DIFFUSER	COLOUR	TRIM COLOUR
VBD	TR5-W	FG	XXX	X
			24K 35K 27K 40K 30K 50K	S B G W

NOTES:  
 FG = Frosted Glass  
 S = Silver  
 G = Gold  
 B = Black  
 W = White



## VBD-TR5-W (Clear Lens)

Model No.	VBD-TR5-W-L
Input Voltage	12V DC
Wattage	5W
Body Colour	Metallic Silver
Available Trim Color	Silver • White • Black • Gold
Diffuser Material	Clear Lens
Fixture Material	Aluminum
Beam Angle	35°
Rendering Index	CRI>90
IP Rating	IP20 (Damp Location)
Dimensions	49mm x 28.5mm (1.93" x 1.12")



### Available Colour Temperatures



### Beam Details

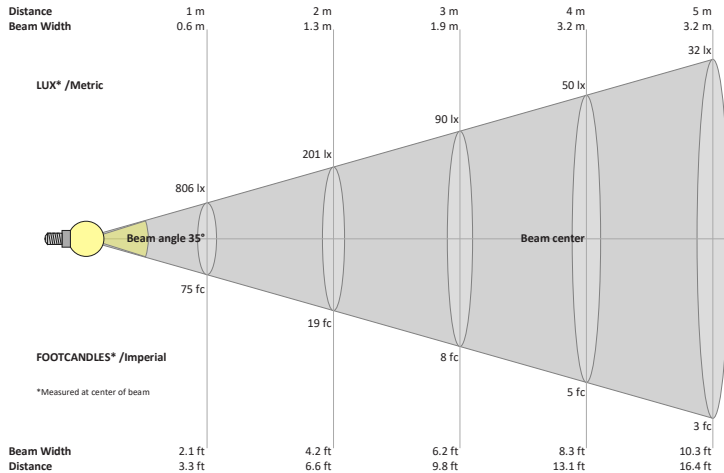

### Beam Angle

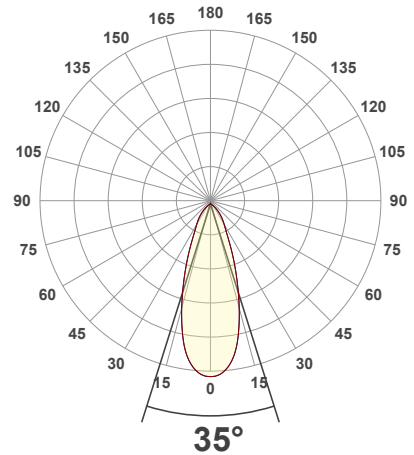

### ORDERING GUIDE

Example part number: **VBD-TR5-W-L-24K-S**

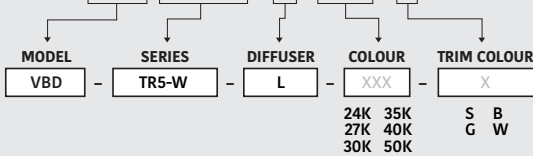

### NOTES:

L = Clear Lens  
S = Silver  
G = Gold  
B = Black  
W = White



## VBD-TR4-RGBW (Frosted Glass)

Model No.	VBD-TR4-RGBW-FG
Input Voltage	12V DC
Wattage	4W
Color Temperature	RGBW
Body Colour	Metallic Silver
Available Trim Color	Silver • White • Black • Gold
Diffuser Material	Frosted Glass
Fixture Material	Aluminum
Beam Angle	110°
Rendering Index	CRI>80
IP Rating	IP20 (Damp Location)
Dimensions	49mm x 28.5mm (1.93" x 1.12")

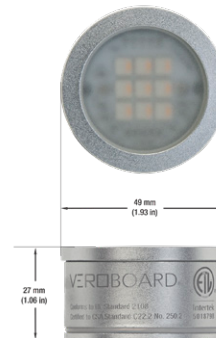

### Beam Details



### Beam Angle

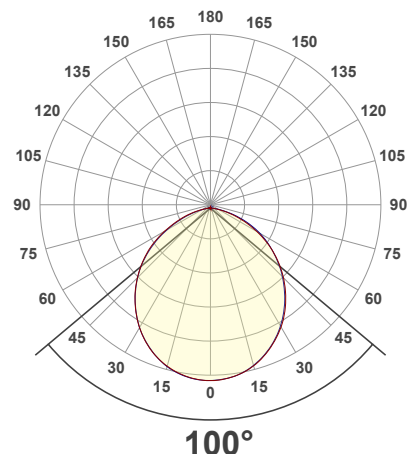

### ORDERING GUIDE

Example part number: **VBD-TR4-RGBW-FG-S**

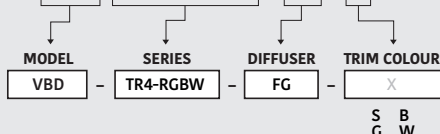

### NOTES:

FG = Frosted Glass  
S = Silver  
G = Gold  
B = Black  
W = White



# AVAILABLE TRIM MODELS

			
MODEL No. VBD-MTR-1C	MODEL No. VBD-MTR-1W	MODEL No. VBD-MTR-13C	MODEL No. VBD-MTR-13W
			
MODEL No. VBD-MTR-13B	MODEL No. VBD-MTR-12C	MODEL No. VBD-MTR-12W	MODEL No. VBD-MTR-12B
			
MODEL No. VBD-MTR-11C	MODEL No. VBD-MTR-11W	MODEL No. VBD-MTR-11B	MODEL No. VBD-MTR-9C
			
MODEL No. VBD-MTR-9W	MODEL No. VBD-MTR-9B	MODEL No. VBD-MTR-7C	MODEL No. VBD-MTR-7W
			
MODEL No. VBD-MTR-14C	MODEL No. VBD-MTR-14W	MODEL No. VBD-MTR-14B	MODEL No. VBD-MTR-2C
			
MODEL No. VBD-MTR-2W	MODEL No. VBD-MTR-8C	MODEL No. VBD-MTR-8W	MODEL No. VBD-MTR-8B
			
MODEL No. VBD-MTR-5C	MODEL No. VBD-MTR-5W	MODEL No. VBD-MTR-6C	MODEL No. VBD-MTR-6W

# AVAILABLE TRIM MODELS



MODEL No. VBD-MTR-3C



MODEL No. VBD-MTR-3W



MODEL No. VBD-MTR-4C



MODEL No. VBD-MTR-4W



MODEL No. VBD-MTR-16C



MODEL No. VBD-MTR-16W



MODEL No. VBD-MTR-10W



MODEL No. VBD-MTR-10B



MODEL No. VBD-MTR-54T



MODEL No. VBD-MTR-59T



MODEL No. VBD-MTR-60T



MODEL No. VBD-MTR-65T



MODEL No. VBD-MTR-67T



MODEL No. VBD-MTR-70T



MODEL No. VBD-MTR-75T



MODEL No. VBD-MTR-76T



MODEL No. VBD-MTR-73T



MODEL No. VBD-MTR-74T



MODEL No. VBD-MTR-77T



MODEL No. VBD-MTR-78T



MODEL No. VBD-MTR-17-1W



MODEL No. VBD-MTR-17C



MODEL No. VBD-MTR-79W



MODEL No. VBD-MTR-80W



MODEL No. VBD-MTR-81W



MODEL No. VBD-MTR-82W



MODEL No. VBD-MTR-83W



MODEL No. VBD-MTR-84W

