



MOBILITY SCOOTER

EW-M35 Instruction Booklet



TABLE OF CONTENTS

INTRODUCTION	1
IMPORTANT PRECAUTIONS	2
SAFETY INFORMATION ON ELECTROMAGNETIC INTERFERENCE (EMI)	3
IDENTIFICATION OF PARTS	5
CHARGING THE BATTERIES	9
DISASSEMBLING YOUR SCOOTER	10
TROUBLESHOOTING	12
CAUTION	13
SPECIFICATION	14

INTRODUCTION

Thank you and congratulations on purchasing your new Ewheels Medical Mobility Scooter.

Indications for Use:

The Ewheels Medical Mobility Scooters EW-M35 are indoor/outdoor scooters that provide transportation for a disabled or elderly person.

We pride ourselves on providing safe and comfortable products. Our goal is to ensure your complete satisfaction with our product. We are certain that you will enjoy your Ewheels Medical mobility scooter.

Please read and observe all warning and instruction provided in the owner's manual before operating this scooter. Also, retain this booklet for future reference.

If you have any questions, you can contact:

Ewheels Medical

6242E Greenway
Parkway #100
Scottsdale, Arizona
85254, U.S.A



or your local dealer:

IMPORTANT PRECAUTIONS

- Only one person at a time could ride a Ewheels Medical Mobility Scooter.
- Maximum load is 115 kg / 255 lbs.
- Turn key off before getting on or off.
- Always drive carefully and be aware of others using the same area.
- Always use pedestrian crossings wherever possible. Take extreme care when crossing roads.
- Do not drive on slope exceeding 6 degree, and take extreme care when turning on slope.
- Do not use full power when turning to sharp corner.
- Take great care and drive in low speed when backing up, riding downhill or on uneven surface, and climbing curb.
- Please use the lowest speed when driving through the descending road or uneven terrain. If speed is too fast, leave your hand off the handle bar, let the scooter stop. Make sure safety and start again.
- A slow speed must always be used when ascending, descending or traversing aslope or incline and also on uneven terrain, ramps and soft or loose surfaces, such as gravel or grass.
- To prevent any danger, do not turn around at high speed on ascending, descending ramp.
- Scooter may not operate well in high humidity.
- Do not leave the powered scooter in a rain storm of any kind.
- Do not use the powered scooter in a shower.
- Direct exposure to rain or dampness will cause the scooter to malfunction electrically and mechanically; may cause the powered scooter to prematurely rust.
- Never put scooter in neutral when staying on slopes.
- Follow traffic laws when riding outside.
- When scooter on moving transport vehicles, do not sit or stay on scooter.

SAFETY INFORMATION ON ELECTROMAGNETIC INTERFERENCE (EMI)

CAUTION : It is very important that you read this information regarding the possible effects of Electromagnetic Interference on your motorized scooter.

Powered wheelchairs and motorized scooters may be susceptible to electromagnetic interference (EMI), which is interfering electromagnetic energy (EM) emitted from sources such as radio stations, TV stations, amateur radio (HAM) transmitters, two-way radios, and cellular phones. The interference (from radio wave sources) can cause the motorized scooter to release its brakes, move by itself, or move in unintended directions. It can also permanently damage the motorized scooter control system. The intensity of the interfering EM energy can be measured in volts per meter (V/m). Each motorized scooter can resist EMI up to certain intensity. This is called its "immunity level." The higher the immunity level, the greater the protection. At this time, current technology is capable of achieving at least a 20 V/m immunity level, which would provide useful protection from the more common sources of radiated EMI. This immunity level of this motorized scooter model is 30 V/m.

There are a number of sources of relatively intense electromagnetic fields in the everyday environment. Some of these sources are obvious and easy to avoid. Others are not apparent and exposure is unavoidable. However, we believe that by following the warnings listed below, your risk to EMI will be minimized.

The sources of radiated EMI can be broadly classified into three types :

1. Hand-held portable transceivers (transmitters-receivers) with the antenna mounted directly on the transmitting unit. Examples include: citizens band (CB) radios, "walkie talkie," security, fire, and police transceivers, cellular telephones, and other personal communication devices;



Some cellular telephones and similar devices transmit signals while they are ON, even when not being used.

2. Medium-range mobile transceivers, such as those used in police cars, fire trucks, ambulances, and taxis. These usually have the antenna mounted on the outside of the vehicle; and

3. Long-range transmitters and transceivers such as commercial broadcast transmitters (radio and TV broadcast antenna towers) and amateur (HAM) radios.



Other types of hand-held devices, such as cordless phones, laptop computers, AM/FM radios, TV sets, CD players, and cassette players, and small appliances, such as electric shavers and hair dryers, so far as we know, are not likely to cause EMI problems to your motorized scooter.

Motorized Scooter Electromagnetic Interference :

Because EM energy rapidly becomes more intense as one move closer to the transmitting antenna (source), the EM fields from hand-held radio wave sources (transceivers) are of special concern. It is possible to unintentionally bring high levels of EM energy very close to the motorized scooter control system while using these devices. This can affect motorized scooter movement and braking. Therefore, the warnings listed below are recommended to prevent possible interference with the control system of the motorized scooter.

Warnings :

Electromagnetic interference (EMI) from sources such as radio and TV stations, amateur radio (HAM) transmitters, two-way radios, and cellular phones can affect motorized scooters. Following the warnings listed below should reduce the chance of unintended brake release or motorized scooter movement which could result in serious injury.

1. Do not operate hand-held transceivers (transmitters-receivers), such as citizens band (CB) radios, or turn ON personal communication devices, such as cellular phones, while the motorized scooter is turned ON;
2. Be aware of nearby transmitters, such as radio or TV stations, and try to avoid coming close to them;
3. If unintended movement or brake release occurs, turn the motorized scooter OFF as soon as it is safe;
4. Be aware that adding accessories or components, or modifying the motorized scooter, may make it more susceptible to EMI; and



There is no easy way to evaluate their effect on the overall immunity of the motorized scooter.

5. Report all incidents of unintended movement or brake release to the distributor listed on the inside front cover of this manual. Note whether there is a source of EMI nearby.

Important Information :

1. 20 volts per meter (V/m) is a generally achievable and useful immunity level against EMI (as of May 1994). The higher the level, the greater the protection.
2. The immunity level of this product is 30 V/m.

IDENTIFICATION OF PARTS

Before attempting to drive this scooter on your own, it is important that you familiarize yourself with the controls, and how to operate them.

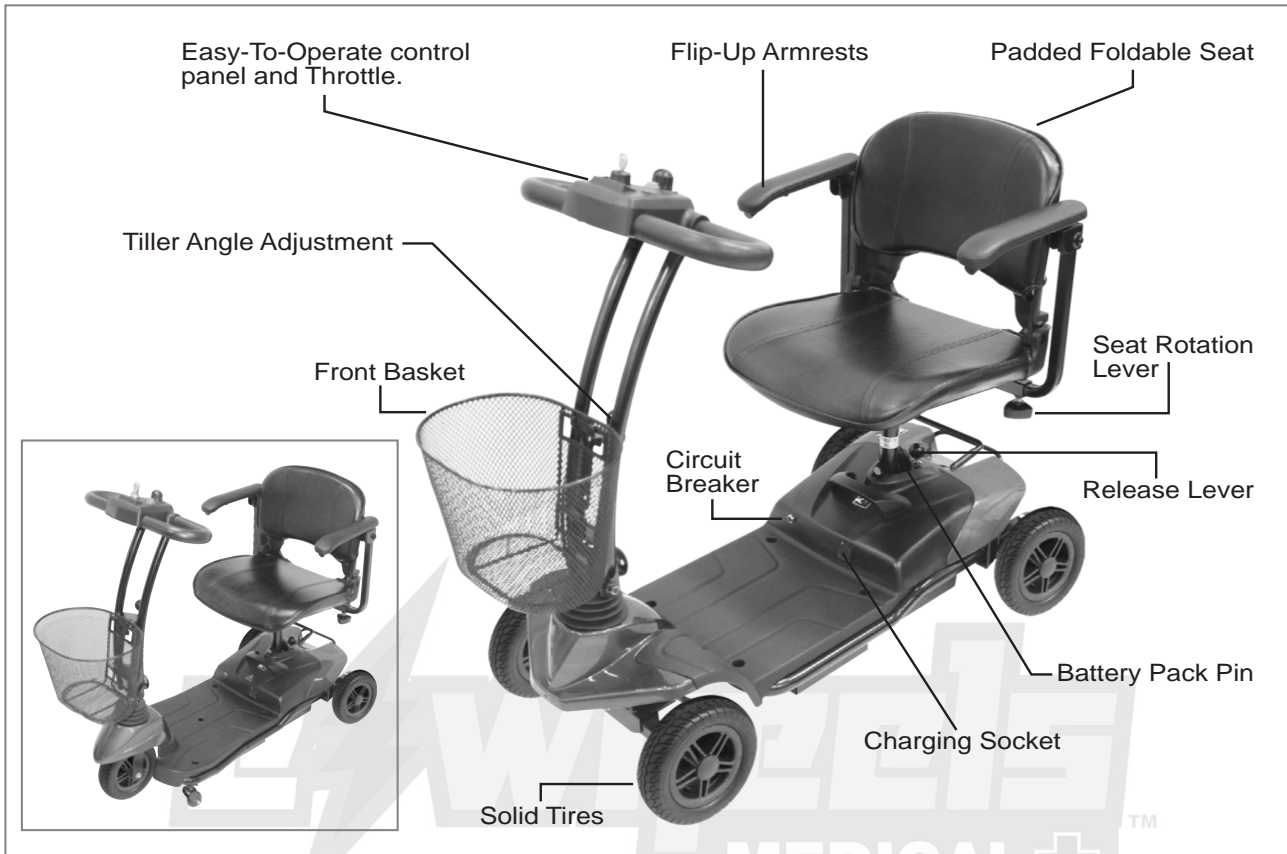

Figure 1 - EW-M35 Front View

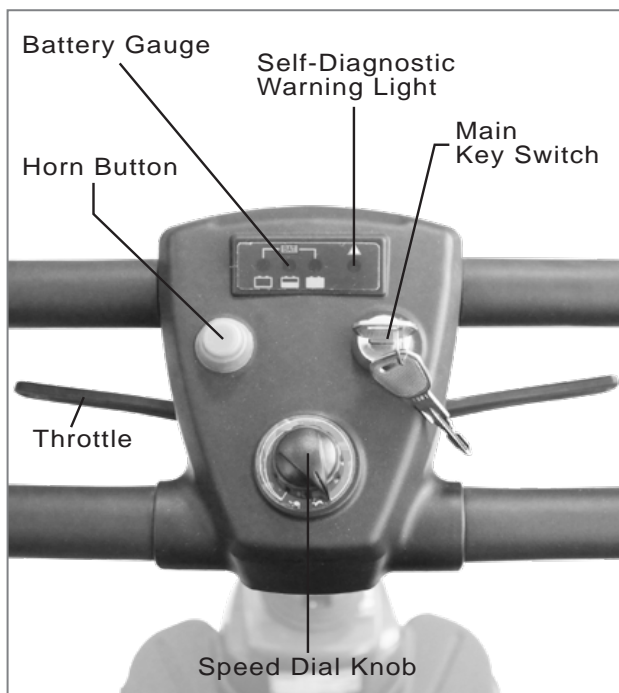

Figure 2 - EW-M35 Top Control Panel

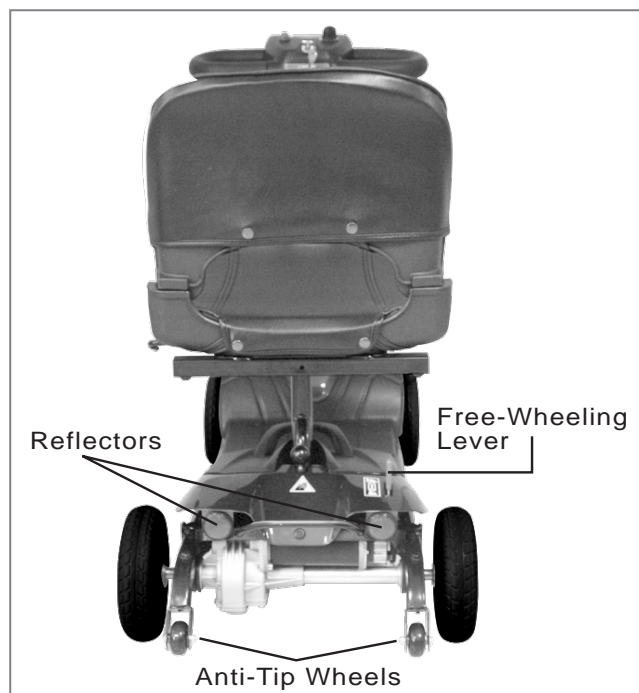

Figure 3 - EW-M35 Back View

OPERATING YOUR SCOOTER

Before operation, please remove the Lock Nut (A) and press button of Circuit Breaker (B) to activate the system.

FUNCTION OF PARTS :

Main Key Switch (C)

1. Turn the key to the right
Turn the scooter on.
2. Turn the key to the left
Turn the scooter off.

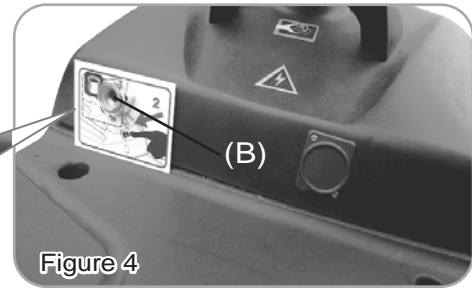
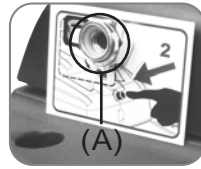

Figure 4



Always ensure that the scooter is switched off before getting on or off the scooter and before removing any items of the scooter.



The ON/OFF key switch must only be operated when in motion, in an emergency. Turning the scooter OFF whilst driving will bring the scooter to an abrupt stop.

Speed Dial Knob (D)

The image of rabbit means fast or high speed.

The image of turtle means slow or low speed.

By turning this knob towards chosen image you can control overall speed of the scooter.

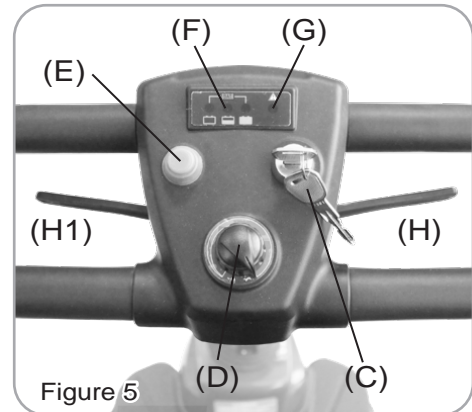

Figure 5



Before driving the scooter, set the speed to low speed by turning the knob towards turtle image,



Drive in high speed when encounter an up slope, and drive in low speed when encounter a down slope.

Horn Button (E)

Press Horn Button (E) once to sound warning tone when necessary.

Battery Gauge (F)

The meter gives an approximation of battery strength. Three coloured lights illuminated indicate batteries are fully charged. The green followed by the amber light will go out as the batteries are used. When only the red light remains on, the batteries need to be charged immediately.

Self Diagnostic Warning Light (G)

Flashing light indicates there is a problem within scooter. See page 12 for more information.

Throttle (H) (H1)

Pulling right Throttle moves scooter forward. (H) Pulling left Throttle moves the scooter backward. (H1) (This can be reversed if required by local dealer.) Releasing both, engages automatic brake. These are also your accelerator. The further you depress them, the faster you go. (Subject to the position of the Rabbit/Turtle control).



Releasing the Throttle engages the automatic brake, but will taxi for a short buffering distance, please keep safe distance when stopping to prevent any danger.

Tiller Angle Adjustment :

- 1.Lift up the lever (I) to disengage the pin.
- 2.Simultaneously, adjust the steering fore-aft to the most comfortable angle. Release lever (I) and ensure the pin is fully engaged to lock the steering column in position.

Seat Rotation Adjustment :

- 1.Lift lever (J) upward to disengage pin.
- 2.Simultaneously, rotate seat (K) (or lift up to disassemble the seat) to the most comfortable angle. Release lever (J) and ensure the pin is fully engaged to lock the seat in position.

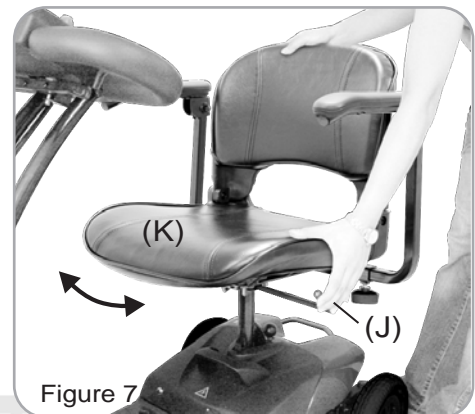
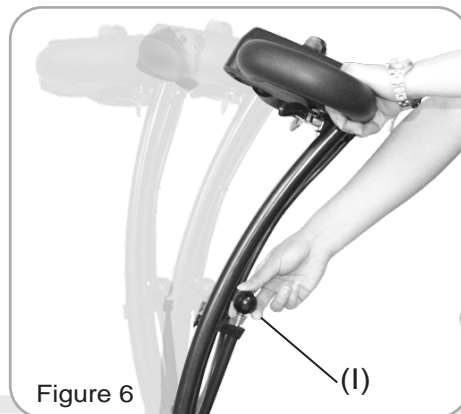
**Circuit Breaker :**

If scooter's circuit system malfunctions or over loaded, the circuit system will automatic shut down the power to ensure driver's safety. After the power is off, press button (L) to regain power.

Free-Wheeling Lever :

To push scooter for short distances, put it in freewheel mode by pushing forward on free-wheel lever to N. This disables the drive system and brake system. To take the scooter out of freewheel mode, pull the free-wheel lever backward to D to re-engage the drive and brake system.

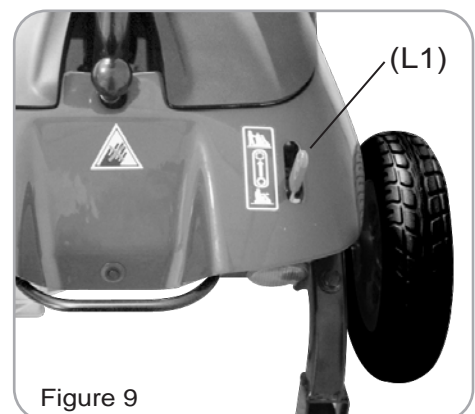
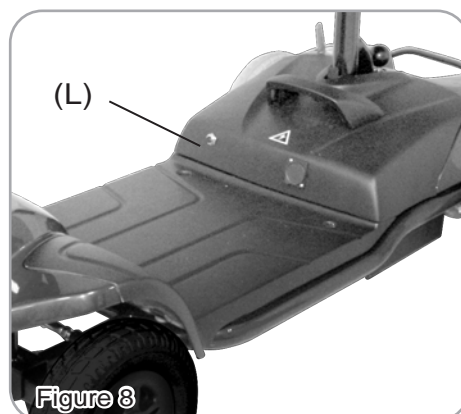

Basket assembling and disassembling :

Remove the Front Basket (L2) and place it off to the side.

Armrest assembling and angle adjustment :

- 1.Remove plugs (L3) at both sides.
- 2.Assembling armrests.
- 3.Adjust armrest to most comfortable angle, then lock with knob (L4).
- 4.Adjust screw's (L5) height, to control armrest's angle.

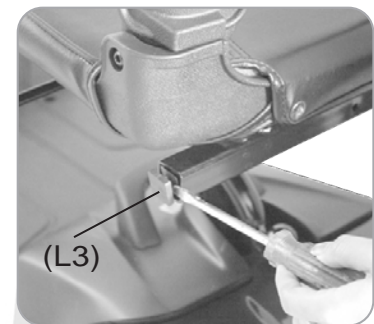
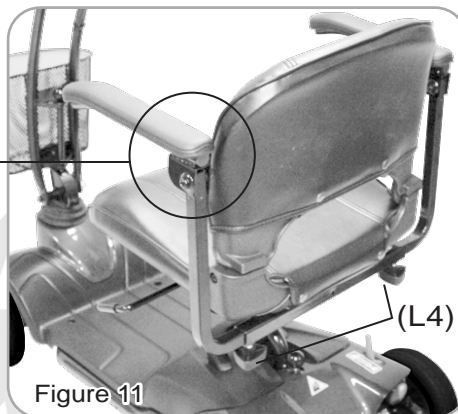
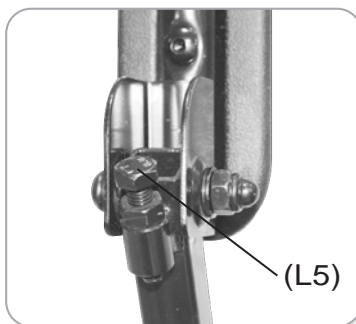
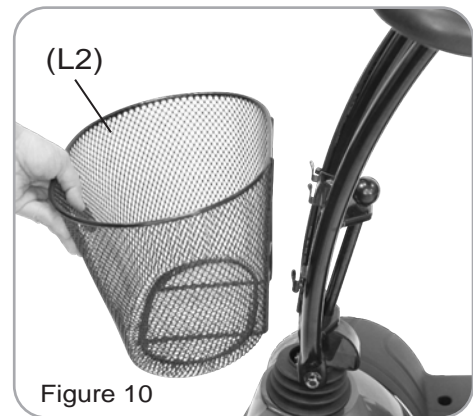
**Seat Height adjustment :**

- 1.Remove the seat, and then remove screw, nut and washer from seat post.
- 2.Adjust seat post to desired height, then attached tightly with screw, nut and washers.
- 3.Assemble the seat back to its original position.
- 4.Seat height adjustability 370mm / 390mm / 410mm.



CHARGING THE BATTERIES

Your Ewheels Medical scooter is equipped with two sealed, maintenance free 12V. 12Ah. rechargeable batteries and one EW-M35 24V/1.8A charger. Batteries must be charged before using scooter for first time and should be recharged after each day's use. Be sure power switch is in OFF position and free-wheeling lever is not in freewheel mode.

For safety reasons, only sealed non-spillable batteries that meet DOT CFR 173.159(d), IATA Packing Instructions, and IATA Provision A67 shall be installed in the scooters. If you need new batteries, contact your dealer. Only 12V. 12Ah Valve-regulated Lead Acid batteries should be used.

1. Insert battery charger cord into Charging Socket (M) on battery pack.
2. Plug other end of power cable into a standard electrical wall outlet.
3. The charging indicator (M) will normally be red or yellow at this point.
4. Allow batteries to charge until charging indicator turns green.
5. After indicator turns green, unplug battery charger from scooter and wall outlet.
6. If at any time battery charger light flashes green over 40 minutes, this indicates abnormal charging occurred.

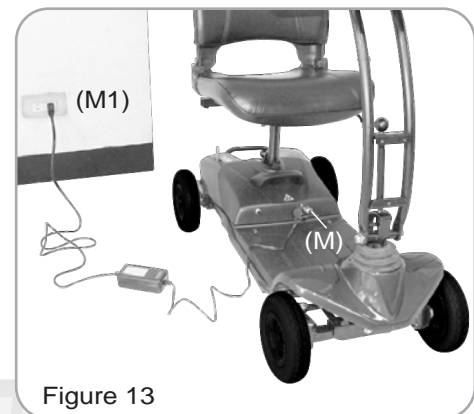

Figure 13

You should check the following:

- Charger plug is correctly positioned
- Scooter is turned off
- If none of these are the problems, contact your local authorized dealer.



The time needed to recharge will vary depending on the depletion of the batteries. Charging for longer than necessary will not harm the batteries. They can not be overcharged.

Keep in mind these rules :

- Fully charge batteries at least once a month, or more if you use scooter regularly. Charge after each trip exceeding 3 kilometers.
- If storing your scooter for some time (1 month or more), make sure that batteries are fully charged, and on returning, charge them again before using scooter.
- Batteries will only give maximum performance after scooter has been used, and batteries have been recharged up to 10 times. A bit like breaking in a new car.

Please be aware that the travelling range of your mobility scooter is impacted by how fast the batteries are discharged. This will depend on many circumstances, such as ambient temperature, condition of the surface of the road, tyre pressure, weight of the driver, driving environment (inclines etc.) and utilisation of your lighting system if fitted. We recommend that you test your local ride with a family member to ensure a safe journey.

DISASSEMBLING YOUR SCOOTER

I. Seat Disassembling :

Remove seat by pulling up Seat Rotation Lever (J). Then lift up away from scooter.

II. Battery Pack Disassembling :

As indication, Push Release Lever (N) backward and pull Battery Pack Handle (O) to remove batteries from scooter. Caution: batteries are heavy. When lifting please use correct lifting posture to avoid injury. Ask for assistance if necessary.



When assembling battery pack (O), make sure to aim for the battery terminal connection for proper electricity conductivity.

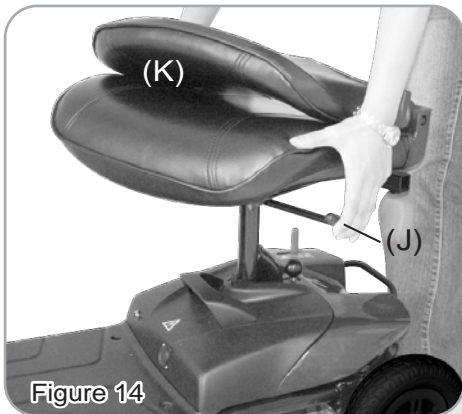

Figure 14

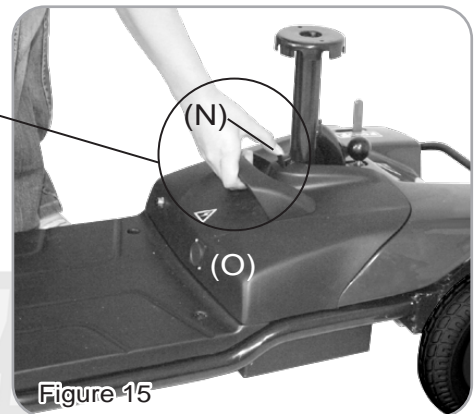

Figure 15

III. Front & Rear Frame Disassembling :

Lift up front & rear frame's fixation pin (P); and hold and pull rear frame as arrow indicates direction to disassembling front and rear frame.



To prevent shroud damage, do not lean disassembled rear frame forward.

When assembling front & rear frame, align left and right sides' stickers and push in to complete the assembly.



Figure 16

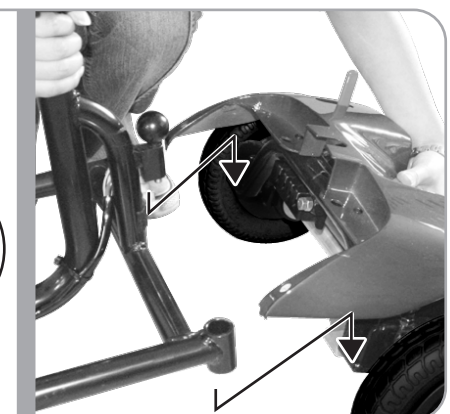
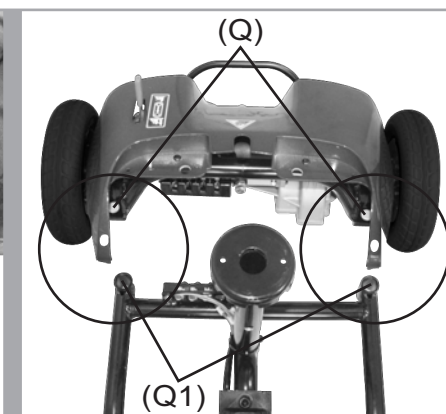

Steering Fold Method :

Lift up the lever (I) to bend down the steering to the lowest hole position and fold down the steering column as shown in Figure 17.



Re-assembling your scooter by vise versa above disassembling procedures.



Figure 17

Fuse Replacement :

1. Remove front shroud's (R) 5 screws (be careful screws' size are different); lift up front shroud (R) as arrow indicates direction.
2. Open fuse box (R1) and replace with backup fuse (R2).



**Replace with same power fuse is required.
After replacement, vise versa assembling procedure to original condition.**

Rim Disassembling :

1. By using a screw driver, to lift up rim (S).

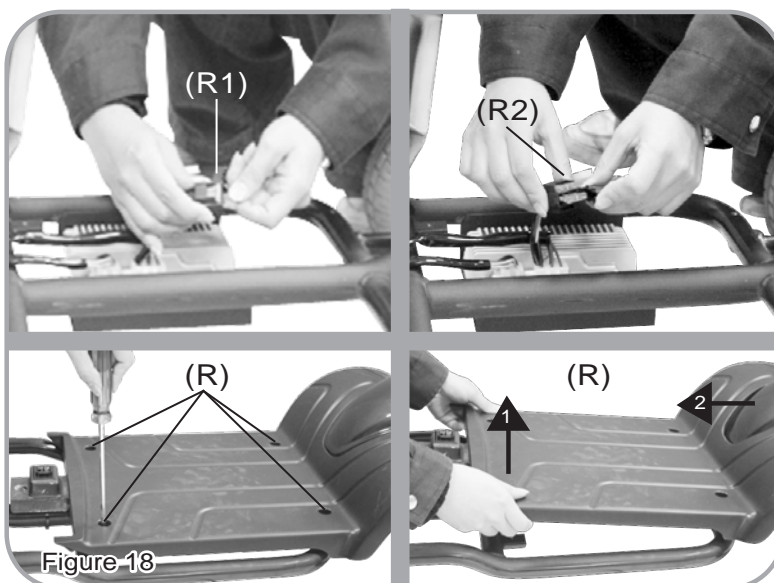

Figure 18

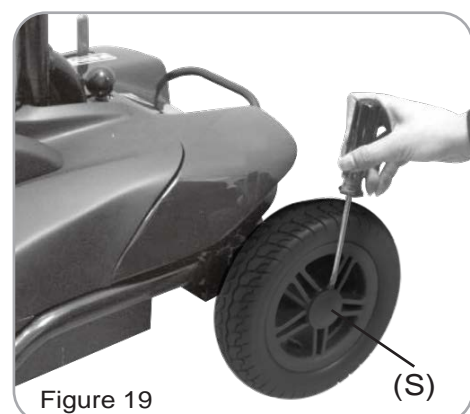

Figure 19

TROUBLESHOOTING

Flash	Description	Meaning
1	Battery Low	The batteries are running low. <ul style="list-style-type: none"> • Recharge the batteries
2	Low Battery Fault	The batteries have run out of charge. <ul style="list-style-type: none"> • Recharge the batteries.
3	High Battery Fault	Battery voltage is too high. This may occur if overcharged &/or traveling down a long slope. <ul style="list-style-type: none"> • If traveling down a slope, reduce your speed to minimize the amount of regenerative charging. • Check the battery and associated connections and wiring.
4	Current Limit Time-out	The motor has been exceeding its maximum current rating for too long. This may be due to a faulty motor. <ul style="list-style-type: none"> • Check the motor and associated connections and wiring. • Turn the controller off, leave for a few minutes and turn back on again.
5	Park Brake Fault	Either a park brake release switch is active or the park brake is faulty. <ul style="list-style-type: none"> • Check the park brake and associated connections and wiring. • Ensure any associated switches are in their correct positions.
6	Throttle OONAPU	The Throttle is out of neutral when turning the controller on. <ul style="list-style-type: none"> • Ensure the throttle is in neutral when turning the controller on. • The Throttle may require re-calibration.
7	Speed Pot Fault	The throttle, speed limit pot or their associated wiring may be faulty. <ul style="list-style-type: none"> • Check the throttle and speed pot and associated connections and wiring.
8	Motor Voltage Fault	The motor or its associated wiring is faulty. <ul style="list-style-type: none"> • Check the motor and associated connections and wiring.
9	Other error	The controller may have an internal fault. <ul style="list-style-type: none"> • Check all connections & wiring.

CAUTION**1. Obstacle Climbing :**

Your scooter can climb obstacles and curbs of up to 35mm / 1.4" in height. Never attempt to overcome an obstacle when on an uphill or downhill gradient! Always approach obstacles straight on! Ensure that the front wheels and rear wheels move over the obstacle in one stroke, do not stop halfway!

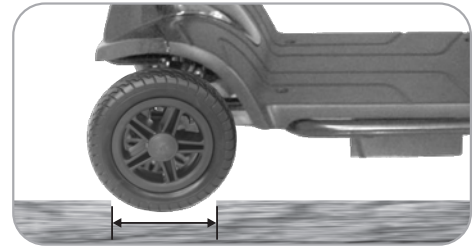
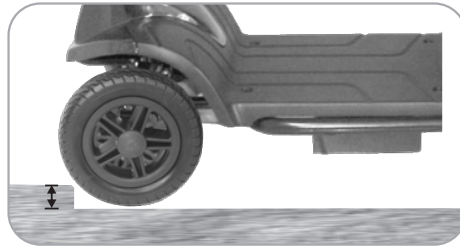
2. The maximum gap the scooter can drive over is 100mm / 4",

- When driving scooter on ramp, adjust body center of gravity to keep scooter more safety.



General driving posture



On ramp, forward your body will let scooter more safety.



In unlikely event of a panel display error, you need to re-set the display system by cycling the on/off main switch. The display circuitry is independent of the motor control system. A display console error does not affect scooter speed control.

OTHER

1. Charge the batteries after each trip. If the scooter is not used for some time, batteries may lose their charge. Batteries should be charged at least once a month.
2. Check the battery gauge before driving to prevent power depletion.
3. Batteries will have an aging phenomenon, where the storage capacity will gradually decrease. If batteries are damaged, please wrap them in a plastic bag and contact your local dealer for proper disposal.
4. Do not disassemble battery and open sealed parts by yourself to prevent electric shock and burns from acid leakage,
5. Adjust speed to a slow speed when starting off to prevent sudden acceleration.
6. Never attempt to drive downhill backwards.
7. Try not to drive scooter at night or in rain or bad weather.
8. If storing your scooter for a long time (1 month or more), make sure that battery are fully charged, then disconnect the two batteries plugs (W), and store the scooter in a dry location.
9. Front basket (accessory), weight capacity 3kgs(6.5lbs).

SPECIFICATION

SPECIFICATIONS	EW-M35
Overall Length	39.4"
Overall Width	20.5" (Armrest Width)
Overall Height	35"
Front Wheels	8"
Rear Wheels	8"
Weight W/ Batteries	88 lbs
Weight Of Heaviest Piece	33 lbs
Max. Speed	4 mph
Weight Capacity	255 lbs
Ground Clearance	1.4"
Grade Climbable	6 degree
Curb Climbable	1.4"
Turning Radius	52"
Brake	Electro-Mechanical
Seat Type	Swivel Padded Foldable
Seat Width	17"
Motor Size	250W, 4700 r.p.m.
Battery Size	(2) 12V. 12Ah
Battery Weight	20 lbs
Travel Range	6.2 Miles
Battery Charger	1.8A Off Board
Electronics	On / Off Key Switch, Battery Level Indicator, Speed Control Knob

*Subject to change without notice. (Rev. 0, 2018/12/07)