

CityCruzer SCOOTER



T4SC

W T -

OWNER'S MANUAL



TABLE OF CONTENTS

1. PREFACE AND INTRODUCTION 2
.....

1. PREFACE AND INTRODUCTION

Please carefully read this owner's manual before using the vehicle. Improper use of the vehicle could result in harm, injury or traffic accidents. Therefore, for maximum pleasure while using the vehicle please read this owner's manual.

- ◆ This owner's manual includes operation instructions for every aspect of the vehicle, assembly instructions, as well as instructions for how to deal with possible accidents.
- ◆ The symbols used in this manual are explained below:
Read especially the notes marked with these symbols:

 Warning	Improper usage could result in serious injury or death
 Attention	Improper usage could lead to injury and/or damage to your scooter.
 Suggestion	Follow these instructions to keep your vehicle in a good operating order.

- ◆ This manual includes a copy of repair and maintenance record chart and warranty information. Please keep it in a safe place or in the scooter.
- ◆ If someone else uses the scooter, please make sure that you provide them with the instruction manual for his or her consideration.
- ◆ As designs change some illustrations and pictures in the manual may not correspond to the vehicle that you purchased. We reserve the right to make design modifications.

Our scooters have been designed and manufactured to provide a comfortable and secure yet affordable solution for some mobility requirements.

Suggestion

To maximize your batteries efficiency and service life, please fully recharge your new battery before its first-time use.

2. SAFETY NOTICE

2.1 BEFORE DRIVING

The user needs to be familiar with the usage and operation of this vehicle before driving. Therefore, please always keep the following safety notices in mind.

- **The same traffic rules apply to the use of this vehicle as apply to pedestrians**

For your safety, please therefore follow the rules that apply to pedestrians.

- ◆ Ride on the pavement, single carriage roads, or pedestrian areas only. Never ride on motorways or dual carriageways.
- ◆ Please do not drive your scooter after consuming alcohol or when you are tired.
- ◆ Please be careful when driving your scooter in low light. It has not been designed for use at night.
- ◆ Be extremely cautious when driving your scooter on busy street or in shopping malls.

- **Practice operating your vehicle**

Before using the scooter in busy or potentially dangerous areas, familiarize yourself with the operation of your scooter. Please practice in a wide and open area like a park. In order to avoid accidents with your scooter while driving, please bear in mind driving motions, such as accelerating, stopping, turning, reversing, up-and down ramps.

- ◆ Please turn the speed dial to low speed position for your initial practice.
- ◆ Be sure someone accompanies you for safety when driving on the roads for the first time.
- ◆ Only use higher speed setting when you are confident that you can easily operate and control your scooter.

- **The CITYCRUZER Scooter is only to be used by one person at a time**

Do not carry passengers on your scooter (including children)

- **Do not use this vehicle to carry or haul goods**

- ◆ As the maximum weight can be carried please refer to “MAX USER WEIGHT” in “7. SPECIFICATION”
- ◆ Maximum loading weight for basket is 3 kg .

- **Please carry out daily inspections.**

Refer to the section entitled “DAILY CHECKING”

2. SAFETY NOTICE

2.2 WHILE DRIVING

- **Please carry out daily inspections.** Refer to the section entitled “DAILY CHECKING”

- **Do not move your body out of the vehicle while moving**
 - ◆ Such action may cause you to lose balance and risk injury from falling.
 - ◆ Pay attention that your clothes do not tangle in the wheels.

- **Do not use your vehicle under the circumstances below.**
 - ◆ On roads with heavy traffic or roads that are muddy, gravelly, bumpy, narrow, snowed over, icy, or canal towpaths not guarded by any fence or hedge. Keep away from places where you might get the wheels stuck.
 - ◆ Do not drive at night or when it is raining, snowing, misty, or windy.
 - ◆ Do not drive your vehicle in an “S” pattern or make erratic turnings.
 - ◆ Do not take the scooter onto escalators.
 - ◆ UNDER NO CIRCUMSTANCES SHOULD THE SCOOTER BE USED AS A SEAT IN A MOTOR VEHICLE (E.G. CARS, BUSES, TRAINS, ETC).

- **About Mobile Phones and other electrical equipment**
 - ◆ Do not use a mobile phone or other wireless communication devices while driving.
 - ◆ Always switch off the scooter and remove the ignition key before using a mobile phone.
 - ◆ Do not charge the mobile phone or any other electrical devices from your scooter’s battery.

- **Automatic Power Shut Down**

In order to avoid accidental battery run down, your scooter is equipped with an automatic power shut down facility. If the scooter is switched on, after remaining undisturbed for a period of fifty minutes it will automatically turn off. Should this occur, simply switch your scooter off and back on and it will be ready to use once again.

- **Ramps, inclines and drops**
 - ◆ Do not drive onto steep ramps greater than the specified gradient. Refer to the section entitled “CLIMBING ANGLE” in “7. SPECIFICATION“
 - ◆ Always use a low speed setting when ascending or descending a gradient.
 - ◆ Do not drive on roads with large drops or potholes.

- ◆ Please slow down when driving on roads with inclines.
- ◆ Do not make sudden turns when driving on gravel roads or ramps.
- ◆ Always lean forward when climbing a steep gradient.

2. SAFETY NOTICE

■ Starting and Driving

1. Make sure the seat is installed properly.
2. Make sure the tiller has been secured properly.
3. Fold down the armrests so you can rest your arms on them.
4. Turn the power switch to “ON”. If necessary, turn on the headlights.
5. Check battery indicator to see whether there is enough power for your journey. If you have any doubt about the remaining power, please recharge the batteries before departure.
6. Set the speed dial to a position you feel safe and comfortable with.
7. Check the forward/reverse speed lever works correctly.
8. Make sure the electromagnetic brake works correctly.
Make sure it is safe around you before you drive on the street.



WARNING !

- ◆ Do not set in the freewheel mode when driving on a gradient.
- ◆ Always re-engage the anti-freewheel device before use. Fail to do so may result in injury.
- ◆ To protect your safety, the power will automatically cut off and electromagnetic brake system will activate while you are driving down a steep gradient. This will limit the speed to a safe level. Turn the power on again to re-start your scooter.
- ◆ **Maximum User Weight Limit**
Refer to section entitled “MAX. USER WEIGHT” in “ 8. SPECIFICATION “. Overloading past the weight limit may lead to damage of your scooter or cause it to malfunction and will endanger your safety. The warranty does not cover this type of damage.

Attention

1. Do not push both RH & LH sides of the speed control lever simultaneously. This might leave you unable to control your scooter.
2. Do not turn the power switch to OFF while driving as this will lead to an emergency stop and possible risk of accident and injury.
3. Do not set to the highest speeds while driving indoors.
4. Do not adjust the speed dial while driving, a sudden change in speed may cause danger to you and others, and may cause damage to your scooter.
5. Do not place magnetic devices near the area of the operation handle as this could affect the safe operation of your scooter.
6. Do be careful while driving in heavy traffic or crowded areas.
7. While reversing the vehicle, beware of people or objects behind you.

2. SAFETY NOTICE

Stopping

1. Release the speed control lever completely. The vehicle will naturally brake and stop.
2. Turn the power switch to (OFF). Then pull out the key.

Driving on the pavement

- ◆ Ensure the 6 km/h limit switch is set to the slowest setting when using the scooter on the pavement.
- ◆ This will limit the scooter to a maximum speed of 6 km/h. It is an offence to travel at more than 6 km/h on the pavement.
- ◆ The limit switch can be set to the fastest setting for use on the road or on private ground.

2.3 LABELING

Please carefully read all labels on the scooter before driving it. For your future reference, do not remove them.

1. CE LABEL



2. WARNING EMI LABEL.....

3. FREEWHEEL LABEL.....



2. SAFETY NOTICE

4. TILLER DUMPING WARNING LABEL.....

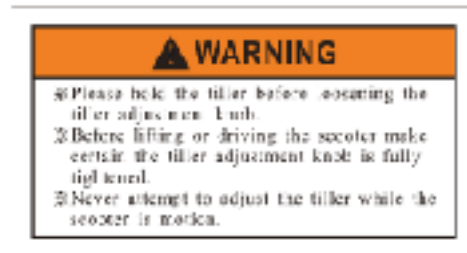

5. SEAT PINCH WARNING LABEL.....



2. SAFETY NOTICE

2.4 EMI

This portion of the content will provide the user with basic information that describes the problems with EMI, known sources of EMI, protective measures either to lessen the possibility or exposure or to minimize the degree of exposure, and suggested action should unexpected or erratic movement occur.

Caution: It is very important that you read this information regarding the possible effects of electromagnetic interference on your electric scooter.

■ **ELECTROMAGNETIC INTERFERENCE (EMI) FROM RADIO WAVE SOURCES**

Powered vehicle may be susceptible to electromagnetic interference (EMI), which is interfering electromagnetic energy (EM) emitted from sources such as radio stations, TV stations, amateur radio (HAM) transmitters, two-way radios, and cellular phones. The interference (from radio wave sources) can cause the powered vehicle to release its brakes, move by itself, or move in unintended directions. It can also permanently damage the powered vehicle's control system. The intensity of the interfering EM energy can be measured in volts per meter (V/m). Each powered vehicle can resist EMI up to a certain intensity. This is called its "immunity level". The higher the immunity level, the greater the protection. At this time, current technology is capable of achieving at least a 20 V/m immunity level, which would provide useful protection from the more common sources of radiated EMI. This powered vehicle model as shipped, with no further modification, has an immunity level of 20 V/m without any accessories.

There are a number of sources of relatively intense electromagnetic fields in the everyday environment. Some of these sources are obvious and easy to avoid. Others are not apparent and exposure is unavoidable. However, we believe that by following the warning listed below, your risk to

EMI will be minimized.

The sources of radiated EMI can be broadly classified into three types:

1. Hand-held portable transceivers (transmitter-receivers with the antenna mounted directly on the transmitting unit. Examples include: citizens band (CB) radios, “ walkie talkie”, security, fire, and police transceivers, cellular telephones and other personal communication devices.
2. Medium-range mobile transceivers, such as those used in police cars, fire trucks, ambulances and taxis. These usually have the antenna mounted on the outside of the Vehicle,
3. Long-range transmitters and transceivers, such as commercial broadcast transmitter (radio and TV broadcast antenna towers) and amateur (HAM) radios;

3. PARTS INTRODUCTION

3.1 PARTS DESCRIPTION

- | | | |
|-----------------------------------|-------------------------|--------------------|
| 1. Power Switch | 2. Charger Socket Cover | 3. Basket Bracket |
| 4. Tiller Adjust Lever | 5. Seat Rotate Lever | 6. Armrest |
| 7. Width Adjustable Armrests Knob | 8. Circuit Breaker | 11. Anti-tip Wheel |
| 9. Under-seat Storage | 10. Freewheel Lever | |
| 12. Connecting Device | 13. Wheel Lock knob | |

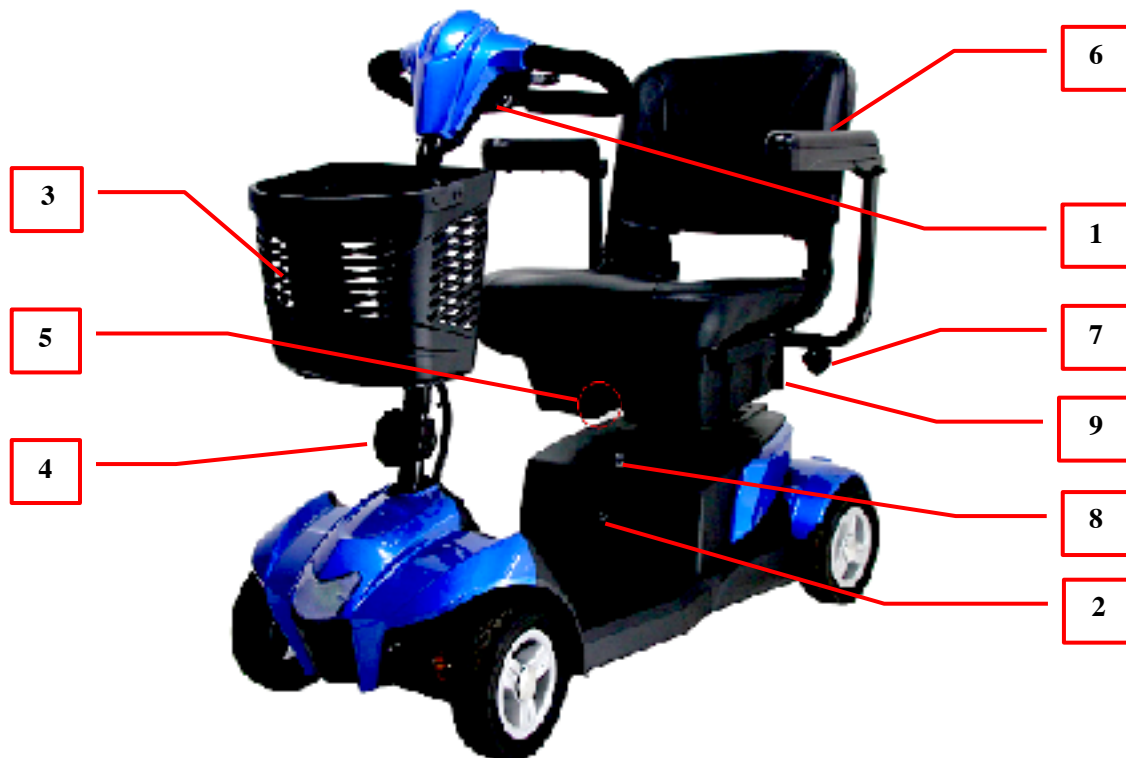



4. OPERATION

4.1 CONTROL PANEL

1. Battery Level Indicator
2. Speed Dial
3. Horn
4. Wigwag Paddle
5. Headlight button



4.2 HOW TO OPERATE YOUR SCOOTER

■ Power switch

Turn the key to power ON or OFF

- (ON) : Power is turned on
- (OFF) : Power is turned off



■ Speed Dial

Press the slowest or fastest setting to determine the maximum speed of the scooter.



Slowest setting

Fastest setting

■ Forward, Reverse, and Braking

- ◆ Pull the speed control lever backwards with your right fingers and the vehicle will move forward.
- ◆ Pull the speed control lever backwards with your left fingers and the vehicle will move backward.
- ◆ The horn will beep when the vehicle is in reverse.
- ◆ Release the speed control lever freely while either going forward or reverse, and the electromagnetic brake in the motor will be activated, and the vehicle will stop.

4. OPERATION

■ Horn Button

Press the horn button to sound the horn. Release the button to stop the horn.

■ How To Set Freewheel Mode

The motor on the scooter can be disengaged to allow the scooter to be pushed.

- ◆ Drive Mode
 - To put the scooter in to “drive” mode, push the freewheel lever down completely
- ◆ Freewheel Mode
 - To put the scooter in to “Neutral” mode, pull the freewheel lever up completely and the scooter can be moved manually.
- ◆ Please note that this will put the scooter in to freewheel mode, so scooter’s motor and brake will be disengaged

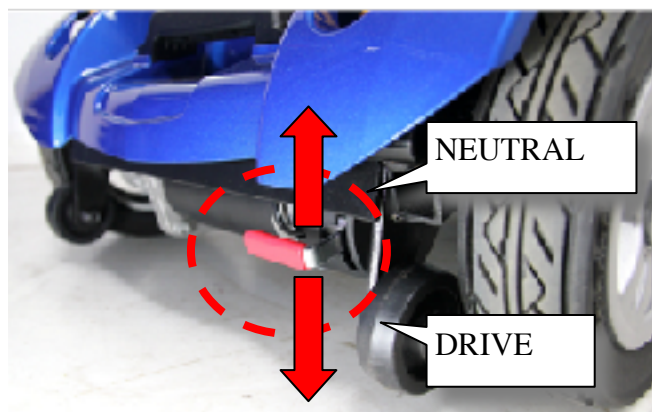

■ Battery Indicator

The battery indicator on the tiller console uses a color code to indicate the approximate power remaining in your batteries. Green indicates (40 ~ 100%) capacity, yellow a draining charge(10 ~ 30%),and red indicates that an immediate recharge is necessary.

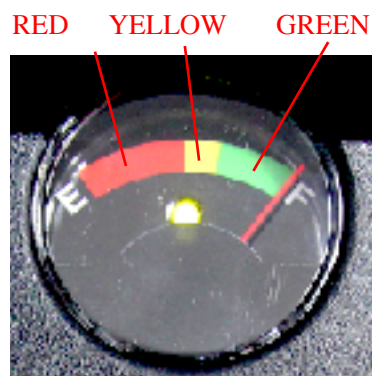

- ◆ The remaining power suggested by the battery indicator will vary by the actual driving time incurred and how you drive. Repeated starting, stopping, climbing will consume the power more quickly.

4. OPERATION

▣ Braking

- ◆ Electro-magnetic brake:
Release the speed control lever completely, and the electromagnetic brake will be activated automatically, and the scooter will stop.

■ Parking

- ◆ After stopping, tune the main key to OFF and remove the key. The lights will turn OFF. The electromagnetic brake is engaged (locked).

☠ Warning

When on a gradient NEVER switch the vehicle to the freewheel mode. The electromagnetic brakes will not be applied. This may result in injury.

■ How to adjust the armrest width

Loosen the knobs at the back of the seat frame firstly, then adjust the armrest width by sliding the armrest. Once satisfied with the width, tighten the knob.



- **Seat**
 - ◆ The seat can be turned to 45 degrees or 90 degrees.
 - ◆ Pull the seat adjustment lever up and swivel seat.
 - ◆ Release the lever, then continue swiveling the seat until it locks in position.

Attention

- ◆ Return the seat to the forward position before driving.
- ◆ Ensure the limit switch is set to the slowest setting when using the scooter on the pavement. It is an offence to travel faster than 4mph on the pavement.

4. OPERATION

- **How to re-position the seat**

Seat Swivel Adjustment:

The seat can be rotated. Lift up on the handle under the left side of the seat and turn the seat to the desired position, releasing the handle to lock the seat in place.



- **Tiller Adjustment**

The tiller can be adjusted in to many different positions to suit each driver.

1. Loosen the lever to adjust the tiller to positions you want.
2. Once decide the position, tighten the lever to secure the tiller.



- **Main Circuit Breaker (Reset Button)**

When the voltage in your scooter's batteries becomes low or the scooter is heavily strained because of excessive loads or steep inclines, the main circuit breaker may trip to protect the motor and electronics from damage.



4. OPERATION

- **How to use the Under-seat storage**

- To operate under-seat storage

1. Lift up slightly on the latch on the side of the under-seat storage bin (See Figure 12) and swing the under-seat storage bin out and away from the travel chair.
2. To close the under-seat storage bin, push the under-seat storage bin toward the center of the travel chair until you hear the latch engage.



WARNING! Ensure both under-seat storage bins are latched prior to operating your travel chair.

- **To remove the under-seat storage**

1. Lift up slightly on the latch on the side of the under-seat storage bin (See figure 12) and swing the under-seat storage bin out and away from the travel chair until it is fully open.
2. Lift the under-seat storage bin up and off the travel chair.

- **To install the under-seat storage**

1. Align the slot on the under-seat storage bin over the securement post.
2. Lower the under-seat storage pin onto the securement post and push the under-seat storage bin toward the center of the travel chair until you hear the latch engage.

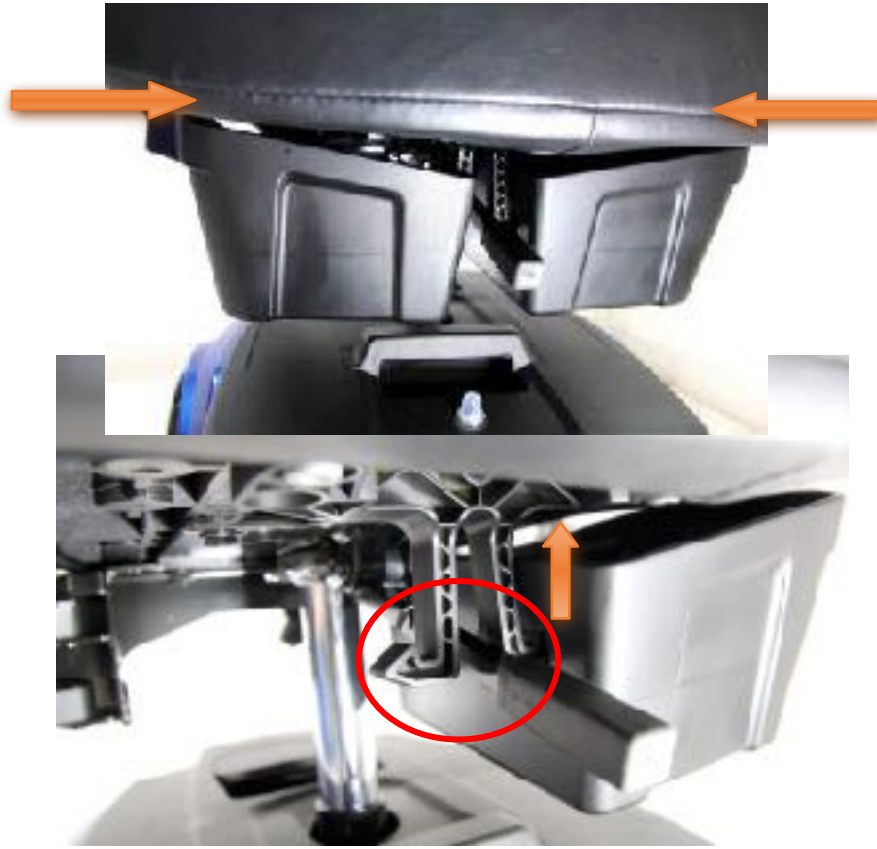

4. OPERATION

4.3 ASSEMBLING AND DISASSEMBLING

■ Assembling The Scooter

No tools are required to disassemble or assemble your scooter.

1. Place the freewheel mode lever in the drive position.
2. Set the rear section in the up position and make sure the hook for the front section is connected to the axle of the rear section.
3. Put down the front and rear sections until the scooter is level.
4. Set down the battery pack on the scooter, and make sure it is in the correct position.
5. Set down the seat on the seat post until the swivel lock engages and you hear a click.
6. Turn key switch to “ON”. Make sure battery gauge indicates sufficient power.

■ Disassembling The Scooter

The **CITYCRUZER** can be disassembled in to four pieces, the seat(11.5 kg /25.3 lbs), the front section (20.7 kg /45.6 lbs),the rear section (11.8 kg / 26 lbs) and battery pack (13.6 kg / 30 lbs).





Warning

To avoid personal injury, ask for assistance, if necessary, while disassembling or assembling your scooter.

Please follow the steps.

1. Make sure the tiller is raised before reassembling the scooter.
2. Turn key switch to “OFF”.
3. Place the free wheel mode lever in the drive position.
4. Take off the basket.
5. Push the Seat Rotate Lever whilst pulling up on the seat to remove.
6. Unlock the battery lock part and rotate the battery lock part.
7. Pick up the battery pack and remove it from the scooter.
8. Loosen the tiller adjustment knob and fold down the tiller and retighten knob.
9. Lock the front wheel and tiller by turn and pull the wheel lock catch down.
10. Pull the connecting device upward to the rear section and stand upright.
11. Take off the front section with both hands and lower the shaft.

4. OPERATION



5. Remove the seat by pull the seat rotate lever.

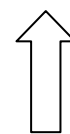

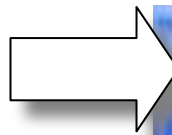
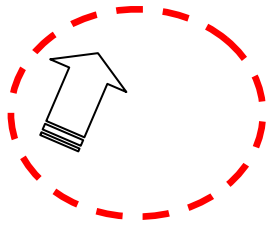

6. Pull up the wheel lock knob to fix the front wheel.



7. Pick up the battery pack and remove it from the scooter.

4. OPERATION



8. Loosen the tiller adjustment knob and fold down the tiller and retighten knob.

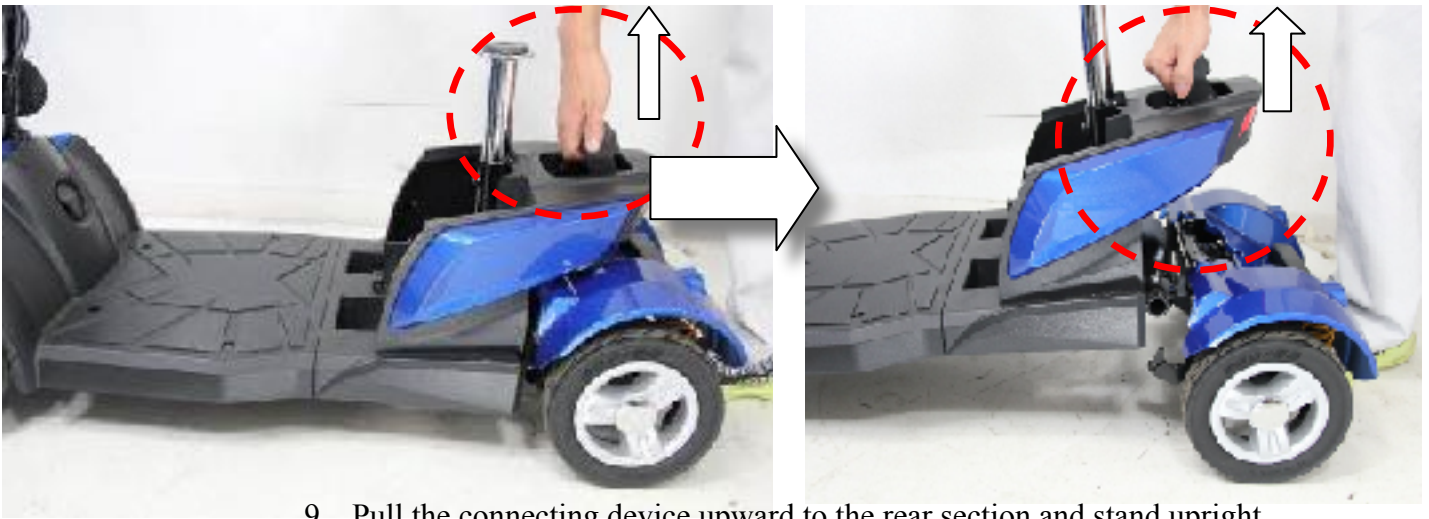

9. Pull the connecting device upward to the rear section and stand upright.



5. BATTERY CHARGING AND CARE

1. CHARGING THE BATTERY

Follow the procedure below step by step:

1. Turn the power switch to (OFF)
2. Connect the charger's power cord into the power outlet.
3. Open the charging socket cap on the battery pack. Then connect the charger's round plug to the charging socket.
4. Turn on the switch on the charger.
5. The charger's LED will be lit green when the power is on, and will turn red when charging. The charging duration is about 6 hours. To ensure optimum performance a 10-hour charge is recommended. But we do not recommend a charging more than 24 consecutive hours.
6. The charger's LED will be lit RED during the charging process. The LED will turn green when charging is completed.
7. Turn off the charger; disconnect the power cord and the round plug from charger socket on the scooter.





Warning

- ◆ The fan inside the charger will be activated accordingly when you turn on the charger. If the fan does not work when connected to the charger or the green light is not showing, DO NOT use this charger. It may lead to overheating of the charger and cause a fire as a result.
- ◆ There is a red LED present on the charger to illustrate operation. If this LED does not illuminate the charger is defective, please contact your dealer.

Attention

- ◆ While gripping or folding the handle bar, beware of finger or hands caught in the handle area.
- ◆ While returning the battery pack to the battery pack cavity of shroud, beware of finger or hands.



Warning

1. Keep away from flammable objects while charging as it may lead to fire or explosion of battery.
2. Do not smoke while charging as the battery may release hydrogen gas. Always charge your battery in a well-ventilated space.
3. Never connect or disconnect the plug or cord with wet hands while charging. Do not connect or disconnect the plug or cord when they are wet, it may lead to electric shock.

NOTE: The immovable function will be activated while your scooter is in charging status, which will make your scooter not run.

5. BATTERY CHARGING AND CARE

Attention - Please follow the rules below to avoid accidents while charging.

1. Please use the CITYCRUZER charger only, and recharge the battery to its full capacity every time. You may damage the battery and scooter if you use a charger, which is not to the correct specification.
2. Please charge in a well-ventilated space where it is not directly exposed to the sunlight. Do not charge in surroundings where it is humid or under rainfall and morning dews.
3. Do not charge in temperatures less than -10°C or higher than $+50^{\circ}\text{C}$ as the charger may not work well and the batteries may become damaged.

2. BATTERY

- ◆ Do not expose the battery to temperatures below -10°C or above 50°C when charging or storing the vehicle. Under the above temperature range can cause the battery either to freeze or over heat. This will damage the batteries and shorten their life.

- ◆ These batteries are maintenance free and there is no need to refill with water.
- ◆ You are required to recharge the batteries on a regular basis. Even if the scooter is stood idle, you should charge the batteries at least once a week.
- ◆ The batteries carry a six-month manufacturer's warranty. This warranty only covers issues relating to manufacturing faults, and not faults relating to failure to recharge the batteries as instructed above.

 **Suggestion – How to maximize your batteries efficiency and service life**

1. Fully recharge your new battery before its first time use.
2. Be sure to charge the battery fully every time. The battery life will be seriously shortened or decayed if the battery is repeatedly used without being fully charged.
3. Always complete the charging until the orange LED light turns green. NEVER stop charging before it is complete.
4. Keep your batteries fully charged whenever possible.
5. If you do not use your scooter for a long time, it should be charged at least every week to keep the battery in a fully usable condition.
6. The ambient temperature will affect charging time. Charging time will be longer in the winter.
7. After charging, do not leave the charger socket plugged in to the scooter, as this will cause a power drain on the scooter and temporarily reduce its range.

5. BATTERY CHARGING AND CARE

■ Cleaning the battery

If the batteries are contaminated by water, battery acid, dust or other substances, they will discharge quickly. The batteries supplied with the CITYCRUZER scooter are sealed and as such are maintenance free with no risk of battery leakage. Please follow the steps below to clean the battery.

1. Turn the scooter power switch to “OFF”.
2. Remove the seat and dust cover.
3. Remove the shroud and unplug the terminal of the taillight and signal lights.
4. Use a clean cloth to wipe off the soiled area.

5. Take out the battery.
6. Clean the battery with a clean cloth. If the terminal is covered by white powder, please wipe it clean using warm water.



Warning

1. The wiring system and charger are well situated in battery pack while assembled in plant. Do not attempt to re-locate the wiring system by yourself. The improper layout of wiring system may result in the wires pinched by battery box, which might the electronic system failure.
2. Be sure the battery wires are connected to their right battery terminal.



Suggestions

If necessary, ask for help from your dealer for advice about maintaining and replacing the battery.



Suggestions

1. Make sure the terminals are installed properly and put the cover back on.
2. Do not use the battery to charge telecom equipment or other items.
3. Battery efficiency will vary with outside conditions; the driving distances will be shorter in the winter. If the vehicle is not used for a long time, please charge the battery at least every week.
4. Replace both batteries together.

6. INSPECTION AND MAINTENANCE

6.1 INSPECTION

- ◆ Clean the scooter with a damp cloth and dust down approximately once a week to preserve the appearance of the scooter.
- ◆ Adjust the tiller height and return to the original position and swivel the seat once a week to ensure the parts adjust and remove smoothly and easily when required.
- ◆ Check for signs of wear and tear on the tires and the upholstery on a regular basis.
- ◆ For optimum performance and to increase the lifespan of your scooter, it is recommended that you have your scooter serviced once a year.

6.2 REGULAR CHECKING RECORD

To make sure your scooter is correctly serviced, take it to your dealer for regular maintenance checks. This should be at intervals of six months after the first inspection after one month. Your dealer may charge a fee for this service.

YEAR	1	2	3	4	YEAR	1	2	3	4
Service Dates					Service Dates				
Controller					Upholstery				
On/off switch					Seat				
Controller Lever					Back				
Braking					Armrests				
Recharge point					Electrics				
Batteries					Connections condition				
Levels					Lights				
Connections					Test run				
Discharge test					Forwards				
Wheels and Tyres					Reverse				
Wear					Emergency stop				
Pressure					Left turn				
Bearings					Right turn				
Wheel nuts					Slope test				
Motors					Over obstacles				
Wiring					List Items repaired				
No Battery									
Connections									
Fuse									
Brake									
Brushes									
Chassis									
Condition									
Steering									

Refer to the section entitled “ 5.2 BATTERY” in “5. BATTERY CHARGING AND CARE ”.

If the battery charger is turned on and no LEDs are lit, check the fuse.

6. INSPECTION AND MAINTENANCE

Suggestion

Ask for help from your scooter dealer to inspect or replace the fuse, since the tiller shroud has to be removed first before you can replace the fuse.

The condition of the tires depends on how you drive and use your scooter.

- ◆ Inspecting tire tread
- ◆ Please check the tread groove regularly. Replace the tires when the tread groove is less than 0.5 mm.

 **Attention**

1. When tread groove is below 0.5mm it can easily lead to vehicle slippage, making braking distances longer. Therefore, replace the tires as early as possible when they do not have insufficient tread depth.

 **Attention**

When conducting maintenance of your vehicle, please turn the power switch to OFF and remove the charger cords.

 **Suggestions**

- ◆ Do not splash water directly to wash your scooter as this could lead to malfunction of the system electrics.
- ◆ Do not use petrol, solvents or vaporizing solution as these may deform or damage the shrouds.
- ◆ Do not use wax.

6.4 STORAGE

Make sure the vehicle is stored under the following circumstances:

- Make sure the seat is set in the “Forward position
- Make sure the Power switch is turned to OFF

 **Suggestion**

Please store the scooter in a location where it is away from the direct sunlight, rain, or dew. When storing for a long time, please charge the battery to full power and then disconnect the battery terminal. For details inquire to your scooter dealer.

6.5 MOVING ABOUT

- ◆ Turn the power switch “OFF” before moving.
- ◆ Lift the scooter by the chassis, and not by the bumpers. Lifting the scooters by the bumper could cause damage or injury.
- ◆ For your safety, always ask for help if required. You will need 2 or 3 persons when moving or lifting the vehicle.

7. TROUBLE SHOOTING AND SPECIFICATION

■ TROUBLE SHOOTING

<i>Symptom</i>	<i>Remedy</i>
The scooter will not switch on	<ul style="list-style-type: none"> • Try recharging the battery • Check the fuse and circuit breaker in the scooter
The scooter switches on, but the scooter will not move.	<ul style="list-style-type: none"> • Ensure there is enough power in the batteries. If not, recharge the batteries. • Ensure the freewheel lever is engaged in the 'DRIVE' position.
The scooter appears slow	<ul style="list-style-type: none"> • Check the battery power level and recharge • Check the speed dial is not set to slow.
The seat turns when in operation	<ul style="list-style-type: none"> • Slowly rotate the seat until it drops in to place and is secure
The handlebar appears loose	<ul style="list-style-type: none"> • Tighten the height adjustment handle to secure the handlebar
Involuntarily horn sounds	<ul style="list-style-type: none"> • Ensure that the wigwag paddle is released. • Switch the scooter off and on. • Recharge the batteries. • If problem persists contact your EV RIDER dealer.

■ SPECIFICATION

Model Reference	CITYCRUZER
Dimension (L x W x H mm) (L x W x H inch)	1080x495x940 42.5x19.5x37
Weight w/i battery	57.5kg /126.7 lbs
Without battery	44kg / 96.8 lbs
Battery	20AH
Controller	Dynamic 50A
Charger	Input AC 100-240V, Output 24V, 2Amp
Front Wheel Size	200x50 mm / 8"x2"
Rear Wheel Size	200x50 mm / 8"x2"
Driving System	Direct drive the rear wheel
Brake System	Electromagnetic brakes
Control Method	By speed control lever
Max Speed Forward	6.4km h /4mph
Slop Grade Ability	8°

Cruising Range	16-20km / 10-13 mile
Max Loading	reserves the right to modify the specification if necessary. The final 130kg / 285lbs individual scooter you purchase from your dealer.
Battery Weight	13.6kg
Seat Weight	based on an ambient temperature of 20°C, a 75kg driver and a brand new 11.5kg fully charged battery by a constant driving speed at 6.4 km/h with 70% battery power discharged.

8. WARRANTY

WARRANTY

There is a comprehensive twelve-month warranty from the date on which your new **CityCruzer** scooter is delivered. The warranty covers the scooter for repairs or replacement during this period. For more detail, please see the Warranty Conditions below.

Warranty Conditions:

1. Any work or replacement part installation must be carried out by an authorized **EV Ride, LLC** dealer / service agent.
 2. To apply the warranty should your scooter require attention please contact the designated service agent listed below.
 3. Should any part of the scooter require repair or full or part replacement, as a result of a manufacturing or material defect within warranty period, the work will be carried out free of charge. Warranty period :
 - a)Frame: 3 Years limited warranty
 - b)Electronic parts: 24 months limited warranty
- Note: The warranty is not transferable
4. Any repaired or replaced parts will be covered by this warranty for the balance of the warranty period on the scooter.
 5. Parts replaced after the original warranty has expired will be covered by a three months warranty.
 6. Consumable items supplied will not generally be covered during the normal warranty period unless such items require repair or replacement clearly as a direct result of a manufacturing or material defect.
Such items include (among others): upholstery, tires and batteries.
 7. The above warranty conditions apply to brand new scooters purchased at the full retail price. If you are unsure whether your scooter is covered, check with the service agent.
 8. Under normal circumstances, no responsibility will be accepted where the scooter has failed as a direct result of:
 - a) The scooter part not having been maintained in accordance with the manufacturer's recommendations.
 - b) Failure to use the manufacturer's specified parts
 - c) The scooter or part having been damaged due to neglect, accident or improper use
 - d) The scooter or part having been altered from the manufacturer's specifications or repairs having been attempted before the service agent is notified

Please note your local service agent's contact details in the box below. In the event of your scooter requiring attention, contact them and give all relevant details so they can act quickly.

The manufacturer reserves the right to alter without notices any weights, measurements or other technical data shown in this manual. All figures, measurements and capacities shown in this manual are approximate and do not constitute specifications.

EV Rider, LLC authorized Service Agent

Name

Address

Tel

Postcode

Warranty Application Form

Name			
Tel no.			
Address			
Model	CITYCRUZER		
Vehicle Data	Scooter Chassis No.:		
	Motor Serial No.:		Key #
Date of Purchase	Year	Month	Day
Agent Signature			

Designed and manufactured by:



Wu's Tech Co. Ltd.

**3 Fl. No.112 Sec. 2, Chung-Shan N. Rd.,
Taipei, Taiwan, R.O.C.
Tel: +886 2 2541 3253
Fax:+886 2 2536 7575**

Distributed by:

EV Rider, LLC

**6410 Arc Way
Fort Myers, FL 33966
Tel: (239) 278-5054
Fax: (239) 278-1431
service@evrider.com
sales@evrider.com**

