

25" Electric Fireplace Insert



Easy | Flexible

- Easily transform your drafty, dated fireplace
- Enjoy warmth and ambiance year-round, with or without heat
- Easy control with the intuitive, multifunction remote
- Stay warm with supplemental heat





Please consult the manufacturer's installation manual for all details and requirements before making a final design layout decision.

25" Electric Fireplace Insert

MODEL	WATTS	FRONT WIDTH A	BACK WIDTH B	HEIGHT C	DEPTH D	STANDARD FRONT E x F	VIEWING AREA G x H
SF-INS25	1,500	24-7/8" [632]	17-7/8" [454]	16-1/4" [413]	11-1/4" [286]	27-7/8" x 17-1/2" [708 x 445]	22" x 12" [559 x 305]

FRONT VIEW

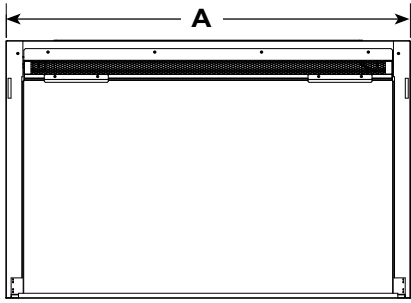

STANDARD FRONT

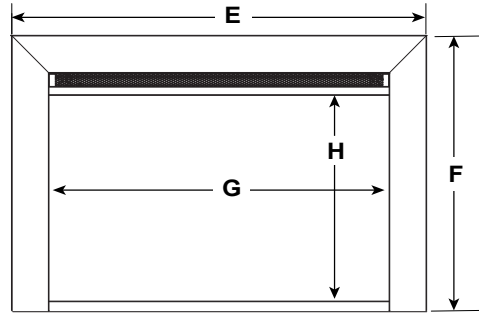

TOP VIEW

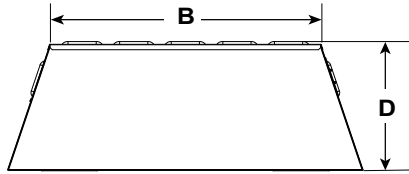

SIDE VIEW

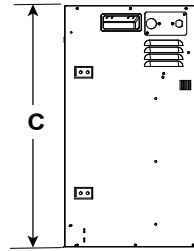

FRAMING WIDTH A	FRAMING HEIGHT B	FRAMING DEPTH C	FRAMING WIDTH D	FRAMING DEPTH E	FRAMING DEPTH F
25-3/8" [645]	16-3/8" [416]	11-3/8" [289]	39-1/4" [997]	28" [711]	20" [508]

TOP VIEW

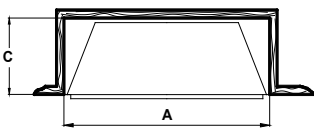

FRONT VIEW

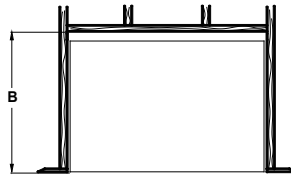

CORNER VIEW

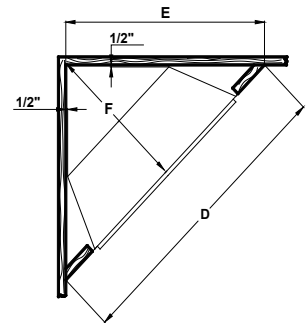

ELECTRICAL CONNECTION REQUIREMENTS

CIRCUIT	CONNECTION METHOD	BTUS
15 AMP, 120V/60 Hz	Hardwire or plug-in	5,000

PRODUCT LISTING CODES	
US	CSA 22.2 No 46-M1988
INTERNATIONAL	CSA 22.2 No 46-M1988

Product information provided is not complete and is subject to change without notice. Product installation must adhere strictly to instructions accompanying product to avoid risk of fire and potential injury.



Additional information can be found online at www.simplifire.com



Lakeville, MN
Phone: 888-427-3973 952-985-6000