

# Solid State Control Packages

- Energy efficiency – including timer functions, control versatility, and ease of use.
- The ability to adjust heating intensity, to achieve the ideal comfort for your space.
- Zone Heating – the capability to control one or more heaters to heat specified target areas within a large-scale space with a single touch.
- The Solid State Relay Panel and Zone Analog Controller with timer work together, and are project specific.
- Electrical wiring diagrams provided for each installation.



30-4045 1 Zone Analog Controller w/ Digital Timer



30-4046 2 Zone Analog Controller w/ Digital Timer



30-4047 3 Zone Analog Controller w/ Digital Timer



30-4048 4 Zone Analog Controller w/ Digital Timer

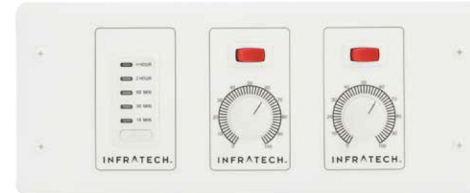

All Zone Analog Controllers also available in white



## SOLID STATE RELAY PANEL

*For use in conjunction with zone analog controllers*

30-4051 1 Relay Panel

30-4052 2 Relay Panel

30-4053 3 Relay Panel

30-4054 4 Relay Panel

30-4055 5 Relay Panel

30-4056 6 Relay Panel

Relay Panels requiring more than six relays are also available by special order. Please contact us for details.

240 VOLT 1Ø 85 AMPS

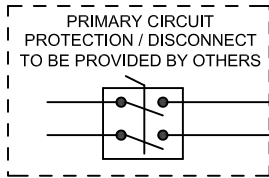

RELAY 1  
8 KW MAX

RELAY 2  
8 KW MAX

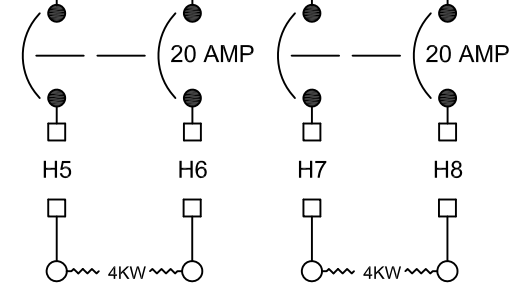
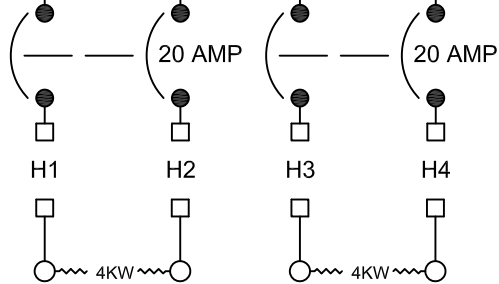
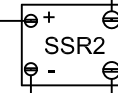
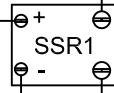

LOW VOLTAGE CONTROL INPUT

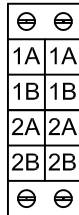

		15700 S. Figueroa St. Gardena, California 90248 Phone: (310) 354-1250 Fax: (310) 523-3674	
		www.infratech-usa.com	
DESCRIPTION			
2 RELAY CONTROL PANEL 240 VOLT SINGLE PHASE 85 AMPS			
CUSTOMER			
Sample			
DATE		ITEM# X-30-4052	
		JOB#	UL#

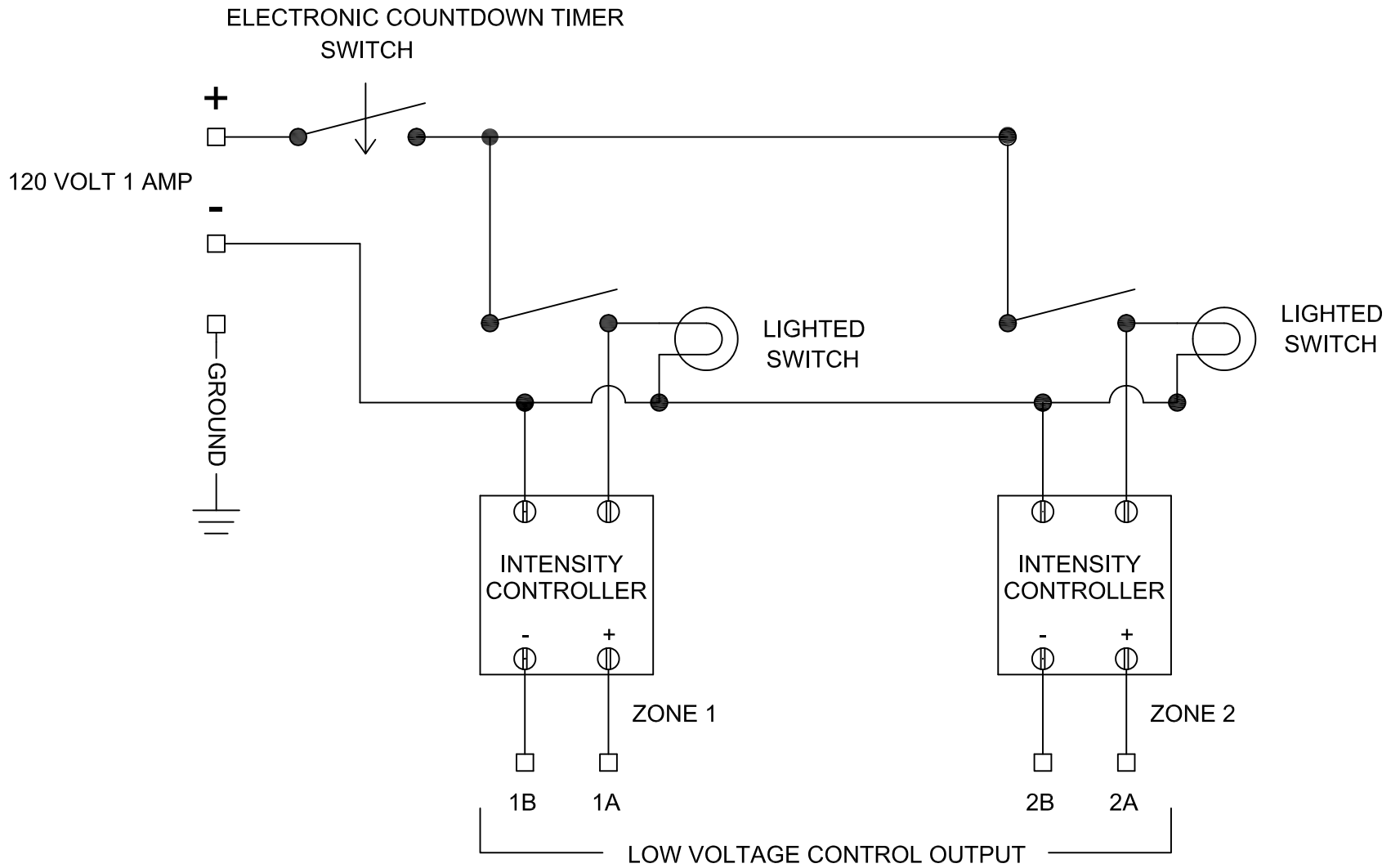

NOTE: USE TWISTED PAIR OR SHIELDED WIRE FOR LOW VOLTAGE HOOK-UP.

<b>INFRA TECH</b> <small>www.infratech-usa.com</small>		15700 S. Figueroa St. Gardena, California 90248 Phone: (310) 354-1250 Fax: (310) 523-3674	
		DESCRIPTION 2 ZONE REMOTE INTENSITY CONTROL UNIT WITH INTERMATIC ELECTRONIC IN-WALL TIMER (15-30-60-120-240 MIN.)	
CUSTOMER		Sample	
DATE	ITEM#	X-30-4046	
	JOB#		