

MODEL	"A" DIM.	WATTS	VOLTS	AMPS	BTU's
W512	19"	500	120	4.2	1706
W7512	19"	750	120	6.3	2559
W1012	33"	1000	120	8.3	3412
W1512	33"	1500	120	12.5	5118
W2024	39"	2000	240	8.3	6824
W2524	39"	2500	240	10.4	8530
W3024	61 1/4"	3000	240	12.5	10236
WD3024	33"	3000	240	12.5	10236
W4024	61 1/4"	4000	240	16.7	13648
WD4024	39"	4000	240	16.7	13648
WD5024	39"	5000	240	20.8	17060
WD6024	61 1/4"	6000	240	25	20472

OTHER VOLTAGES ALSO AVAILABLE: 208, 277, 480

INFRA TECH <small>www.infratech-usa.com</small>		344 W 157th Street Gardena, California 90248 Phone: (310) 354-1250 Fax: (310) 523-3674	
		DESCRIPTION	
W-SERIES HEATER CAD DRAWING			
DATE	DRAWN BY:	SCALE	
Apr. 12, 2019	MD	NA	

INSTALLATION TYPES

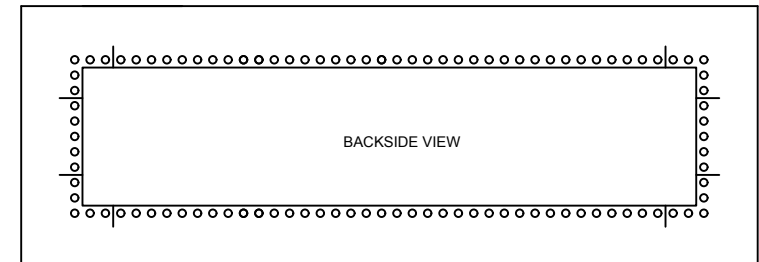
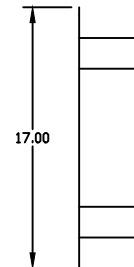
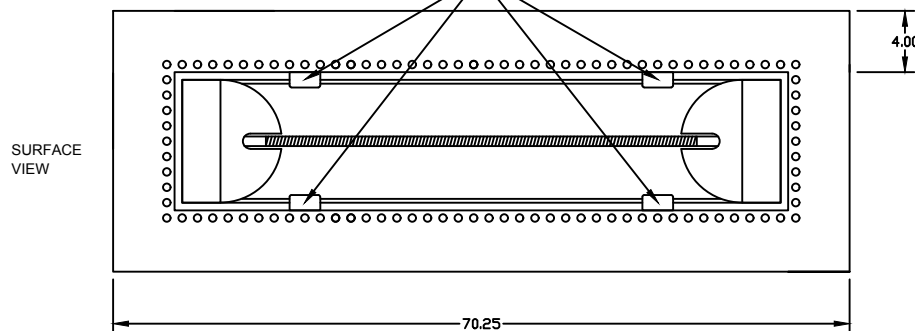
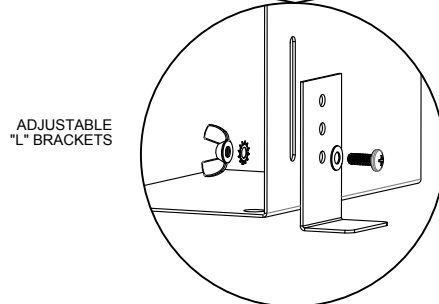
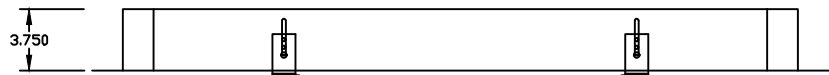
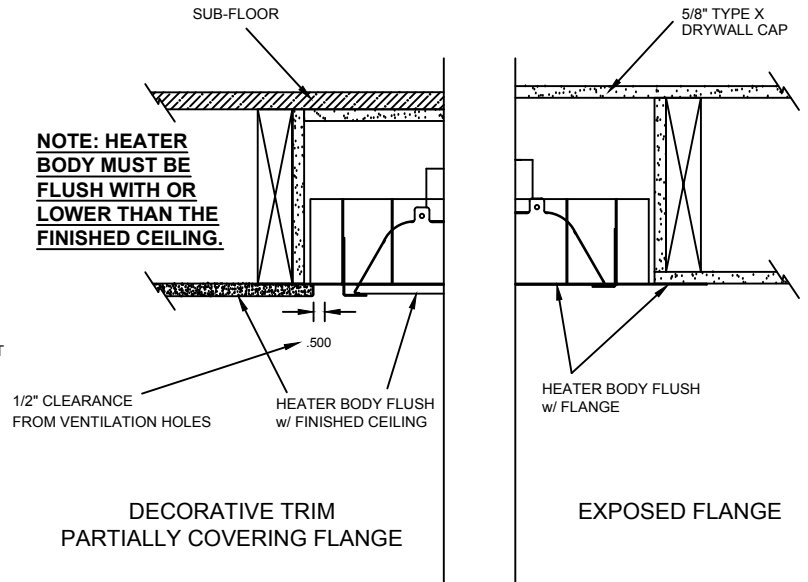
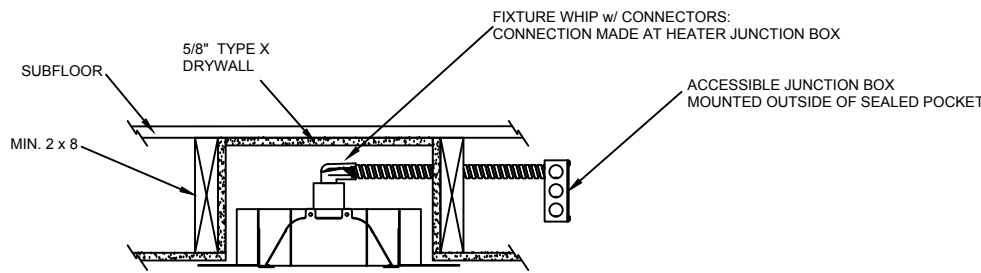
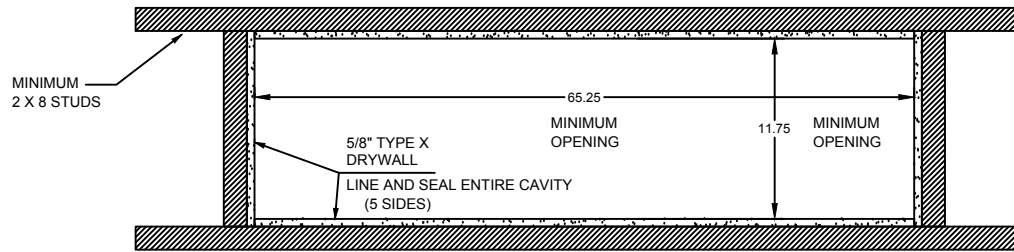

WARNINGS:

Do not use Surface Mount Brackets. This Frame is ONLY to be used on a flat non-sloped ceiling. Heater Body must face straight down and be flush with the finished ceiling. Frame and Heater cannot be installed on a pitched angle. Accessible Junction Box must be installed outside of sealed drywall pocket. Must use 5/8" type "X" drywall. Must use supplied 4 foot Hi-Temp Fixture Whip and Hi-Temp Ceramic Wire Nuts. Please contact factory for longer length Hi-Temp Fixture Whips available for purchase. Discard Surface Mounting Brackets provided with Heater and use "L" Brackets. Use Licensed Electrician ONLY.

NOTES:

Heater suspends (Gravity) by resting on adjustable "L" Brackets in flush mount fixture. Mounting holes on Surface Flange to be determined and drilled by Contractor/Installer. Coil excess flex into heater cavity.

After 4 hours of continuous use, a 15 minute cool down period is recommended for maximum heater longevity. See controls brochure for timer options.

INFRA TECH www.infratech-usa.com		344 W 157th Street Gardena, California 90248 Phone: (310) 354-1250 Fax: (310) 523-3674	
		ITEM #: 18-2305	MATERIAL: 304 S.S. #4 FINISH
DESCRIPTION: W-61 FLUSH MOUNT FRAME (FOR USE WITH 61 1/4" HEATERS)			
NOTES: SUPPLIED w/ HI-TEMP FIXTURE WHIP			
DATE: Dec. 16, 2019	SCALE: N/A	DRAWN BY: CL	