



# European Home

INSTRUCTIONS MUST BE KEPT AFTER INSTALLATION  
FOR FUTURE MAINTENANCE

## Suite Instruction Guide



### Important Safety Information

Always read this manual first before attempting to install or use this fireplace. For your safety, always comply with all warnings and safety instructions contained in this manual to prevent personal injury or property damage.

**Please Note:** Once your European Home product has been installed and switched to the **ON** position, the fire will instantly flash. This is normal operating procedure, simply indicating that there is power running to the fire and **NOT** a fault.

English

12/23/22 - SUITES

**SERIAL NUMBER LABEL**

## Contents

<b>1.</b>	<b>Introduction</b>	<b>2</b>
<b>2.</b>	<b>Electrical Safety</b>	<b>3/4</b>
<b>3.</b>	<b>Important Instructions</b>	<b>5</b>
<b>4.</b>	<b>Installation Method</b>	<b>6/7</b>
<b>5.</b>	<b>E-Touch &amp; App Interface</b>	<b>8</b>
<b>6.</b>	<b>Product Operation</b>	<b>9/10</b>
<b>7.</b>	<b>Technical Specification</b>	<b>10</b>
<b>8.</b>	<b>Log Set Guidance</b>	<b>11</b>
<b>9.</b>	<b>Problem Solving Chart</b>	<b>12/15</b>
<b>10.</b>	<b>E-tab &amp; App Pairing</b>	<b>16/24</b>
<b>11.</b>	<b>Warranty</b>	<b>25</b>

This guide is designed to aid in the installation and continued performance of this product. This product conforms with all health, safety, and environmental protection standards as indicated by a CE mark. For optimum performance this product requires a well insulated location and indoor use.

## **ELECTRICAL SAFETY:**

**When using electrical appliances, basic precautions should always be followed to reduce the risk of fire, electric shock, and injury to persons, including the following:**

- ① Read all instructions before using this electric fireplace.
- ② This fireplace is hot when in use. To avoid burns, do not let bare skin touch hot surfaces. The trim around the heater outlet becomes hot during heater operation. DANGER: High temperatures may be generated under certain abnormal conditions. Do not partially or fully cover or obstruct the front of this heater.
- ③ Extreme caution is necessary when any heater is used by or near children or people of reduced mobility and whenever the unit is left operating and unattended.
- ④ Young children should be supervised to ensure that they do not play with the appliance.
- ⑤ The appliance is not intended for use by young children or infirmed persons without supervision.
- ⑥ In the event of a malfunction, disconnect power at the service panel and have the unit inspected by a reputable electrician before reusing.
- ⑦ If the supply cord is damaged, it must be replaced by the manufacturer, or its service agent, or a qualified person in order to avoid a hazard.
- ⑧ Do not use outdoors.
- ⑨ Never locate fireplace where it may fall into a bathtub or other water container.
- ⑩ To disconnect the fireplace, turn the controls off, and turn off power to heater circuit at main disconnect panel.
- ⑪ Do not run the cord under carpeting. Do not cover cord with throw rugs, runners, or the like. Arrange cord away from traffic area and where it will not be tripped over.
- ⑫ Do not locate the heater immediately below a fixed socket-outlet.

- ⑬ Do not insert or allow foreign objects to enter any ventilation or exhaust opening as this may cause an electric shock or fire, or damage to the heater.
- ⑭ To prevent a possible fire, do not block air intakes or exhaust in any manner.
- ⑮ All electrical heaters have hot and arcing or sparking parts inside. Do not use in areas where gasoline, paint, or flammable liquids are used or stored.
- ⑯ Use this fireplace only as described in this manual. Any other use not recommended by the manufacturer may cause fire, electric shock or injury to persons.
- ⑰ Do not change the plug in any way. Always plug heaters directly into a wall outlet/receptacle. Never use with an extension cord or relocatable power tap (outlet/power strip).
- ⑱ Do not burn wood or other materials in the electric fireplace.
- ⑲ Do not strike the fireplace glass.
- ⑳ Always use a certified electrician should new circuits or outlets be required.
- ㉑ Always use properly grounded & fused outlets.
- ㉒ Disconnect all power supply before performing any cleaning, maintenance or relocation of the unit.
- ㉓ When transporting or storing the unit and cord, keep in a dry place, free from excessive vibration and store so as to avoid damage.

**NOTE: Changes or modifications not expressly approved by the party responsible for compliance could void user's authority to operate the equipment.**

# INSTALLATION REQUIREMENTS:

## Review and consider all the following conditions before installation:

Ensure installation does not allow the electric fireplace to be in direct contact with building vapor barrier or insulation and meets all local building code. A 15 Amp, 120 Volt circuit is required. A dedicated circuit is preferred but not essential in all cases. A dedicated circuit will be required if, after installation, the circuit breaker trips or fuse blows on a regular basis when the heater is operating. Additional appliances on the same circuit may exceed the current rating of the circuit breaker.

Ensure the power cord is not installed so that it is pinched or against a sharp edge and ensure that the power cord is stored or secured to avoid tripping or snagging to reduce the risk of fire, electric shock or injury to persons. Construction and electrical outlet wiring must comply with local building codes and other applicable regulations to reduce the risk of fire, electric shock and injury to persons.

Fig 1.

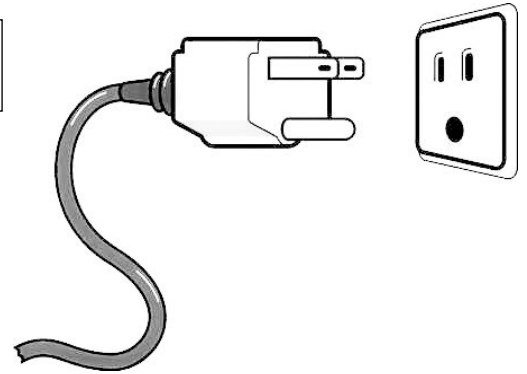

**WARNING:** To reduce the risk of fire, do not store or use gasoline or other flammable vapors or liquids in the vicinity of the heater.

1. Select a location that is not susceptible to moisture and is away from drapes, furniture and high traffic.
2. For ease of electrical hook up you may wish to locate the fireplace near an existing outlet (for plug-in convenience).
3. Remove electric fireplace, front glass and hardware from the box and remove all packaging materials before installation.
4. Store the fireplace in a safe, dry and dust free location until you are ready to install the fireplace.

## Grounding Instructions:

This product must be grounded. If it should malfunction or breakdown, grounding provides a path of least resistance for electric current to reduce the risk of electric shock. This product is equipped with a cord having an equipment-grounding conductor and a grounding plug. The plug must be plugged into an appropriate outlet that is properly installed and grounded in accordance with all local codes and ordinances.

**DANGER:** Improper connection of the equipment-grounding conductor can result in a risk of electric shock. Check with a qualified electrician or serviceman if you are in doubt as to whether the product is properly grounded. Do not modify the plug provided with the product – if it will not fit the outlet, have a proper outlet installed by a qualified electrician. This product is for use on a nominal 120-volt circuit and has a grounding plug that looks like the plug in **Figure 1**. Make sure that the product is connected to an outlet having the same configuration as the plug.

**WARNING: Do not attempt to wire your own new outlets or circuits. To reduce the risk of fire, electric shock or injury to persons, always use a licensed electrician. PLEASE NOTE: This appliance cannot be wired into a wall and must use the provided cord and a wall outlet.**

## **INSTALLATION METHOD:**

This product has been designed to be installed onto a plaster board, drywalled, or existing masonry chimney breast.

Please seek advice from a professional, with reference to the structural integrity of the installation site.

**PLEASE NOTE: The screws and wall plugs provided are only suitable for a solid wall fixing / when installing onto a hollow-stud wall it is recommended that heavy duty wall anchors or equivalent are used.**

The product should never be sealed into a opening with the use of silicones or adhesives as this can also alter the airflow and hinder any further servicing of the product.

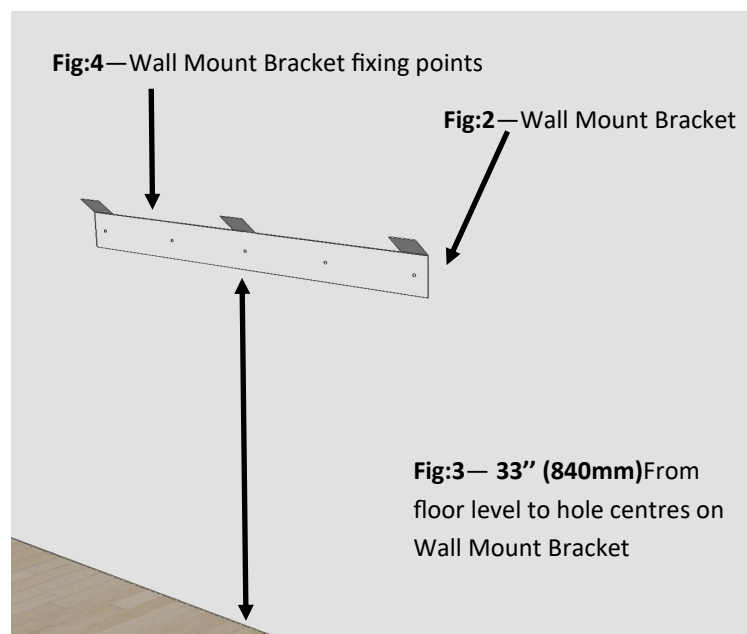

### **Installing Product:**

Each Compton2 & Compton 1000 product is supplied complete with one wall mounting bracket. (See Fig:2)

Establish the desired finished height from floor level to the bottom of the hearth of the product.

(See Fig:3) - 33" (840mm) Dimension is used as standard installation.

Fix the wall bracket to the wall ensuring to use the correct hardware fixings given the wall construction, dry wall or Solid Wall.

(See Fig:4) - Five Fixing points for Wall Mount Bracket

**PLEASE NOTE: Once the product has been fitted into place, please ensure the fire is plugged in and tested to check the fan and ribbons are aligned correctly, and the ribbons are moving freely. It may take up to 20 mins of usage for user to see**

Once the Wall mount Bracket is securely in position, Lift and hook the product onto the wall bracket, slotting the wall bracket into the x3 slots in the rear of the product (See Fig:5) ensuring to keep the product level.

Once the product is secured to the wall, Connect the power supply to the product— Inlet located on the right-hand side underneath the hearth section.

(See Fig:6)

Connect the power socket into the wall power outlet.

The product is now ready to use.

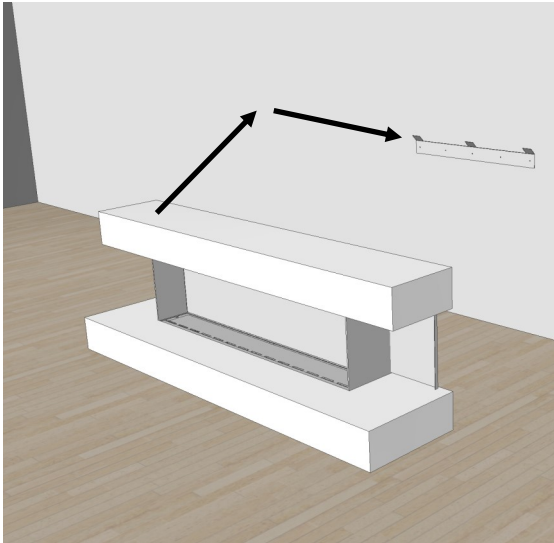

**Fig:5—Lift & Hook product to wall mount bracket**

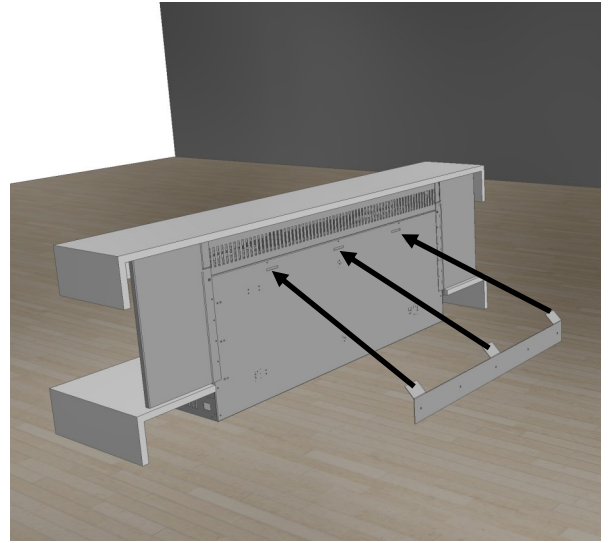

**Fig:5— Lift & Hook the product onto the wall mount bracket using x3 slots in the rear of the product**

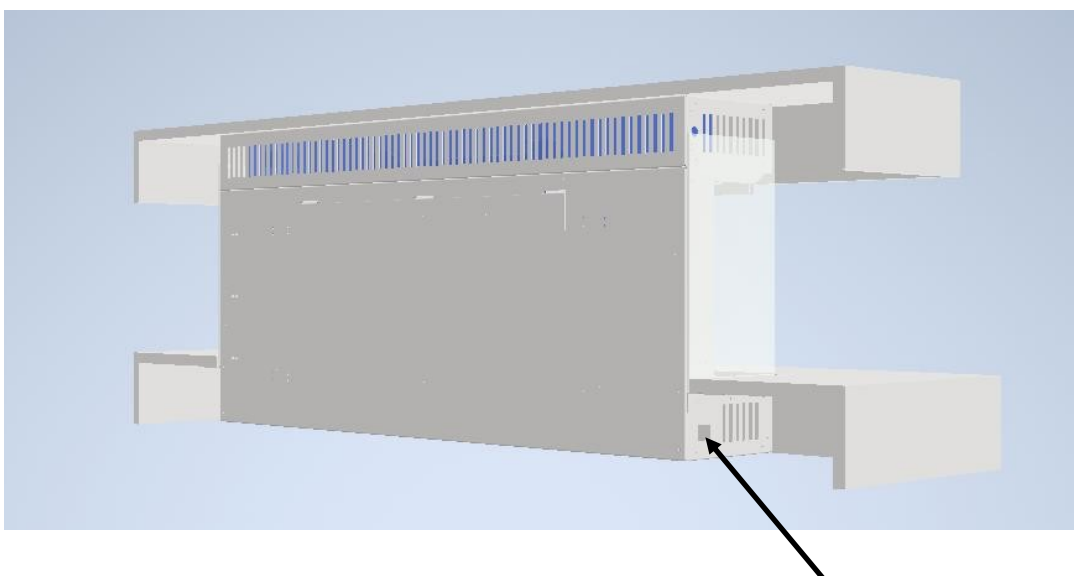

**Fig: 6— Power supply Inlet.**

## E-Touch & App Interface:

The Appliance is operated using the E-Touch App Control.

The App Control can be used on either OS or Android operating systems.

To obtain the App please visit either the Apple App Store Or Google Play and follow the on screen instructions.

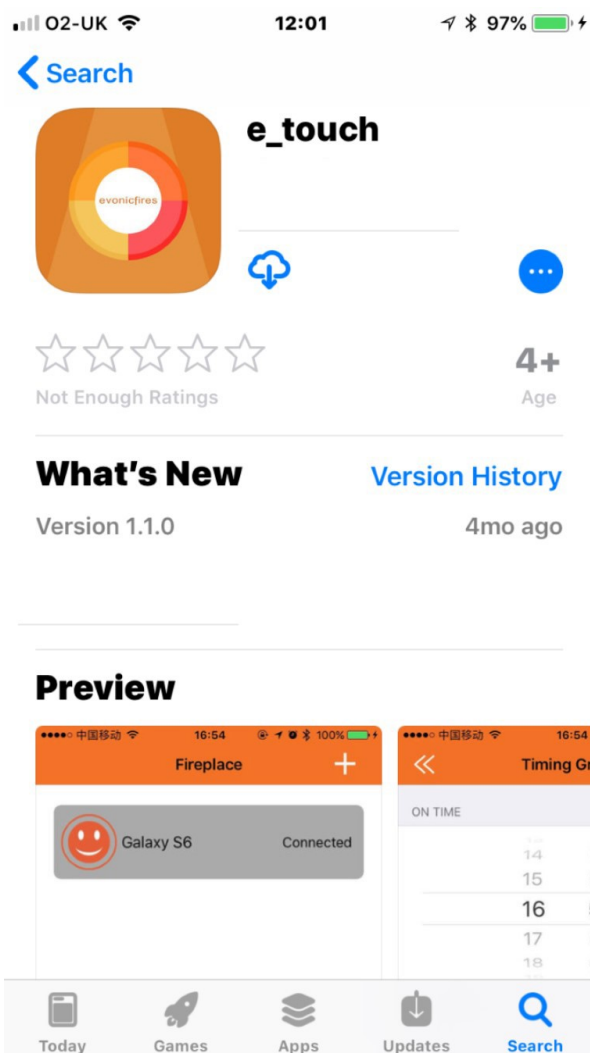

Screen shot taken from Apple App Store.

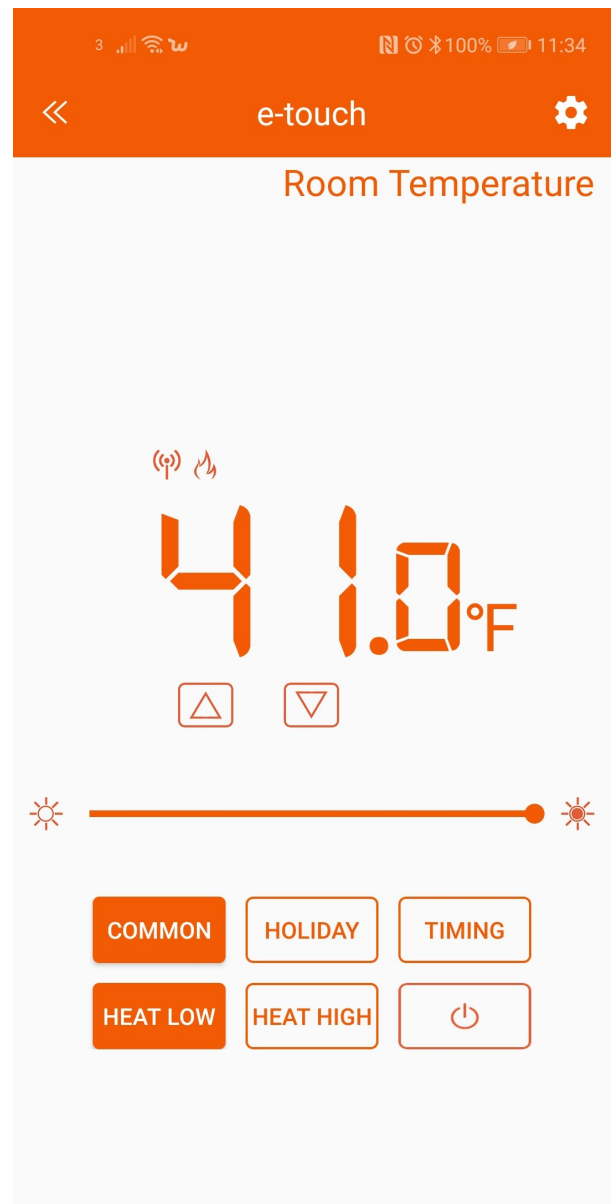

Home Screen shot taken from E-Touch App



## Product Operation:

The appliance is operated by the e-touch App. The main standby power switch to the suite product is located to the right of the heater outlet, and is marked with a light bulb image (Fig 7). To activate the product, this switch must be switched to the "ON" position (Fig 8)

The first time the e-series product is activated both the illumination and heater will function, to switch the heater "OFF" simply reduce the Room Temperature down to 10 degrees on the App control.



Fig 7.



Fig 8.

**(Heater unit cut-out)** (This is a safety feature, to safe guard against further damage to the product).

If the airflow is restricted the heater will automatically turn off. This is can occur due to incorrect installation or obstruction.

To reset the heater function:

- isolate from the mains power supply.
- Leave product to cool.
- After a suitable cooling down period, remove the obstruction if obstructed, and check installation.
- After 10 minutes the thermo switch (cut-out) in the heater will reset.

# Compton 1000 Specification:

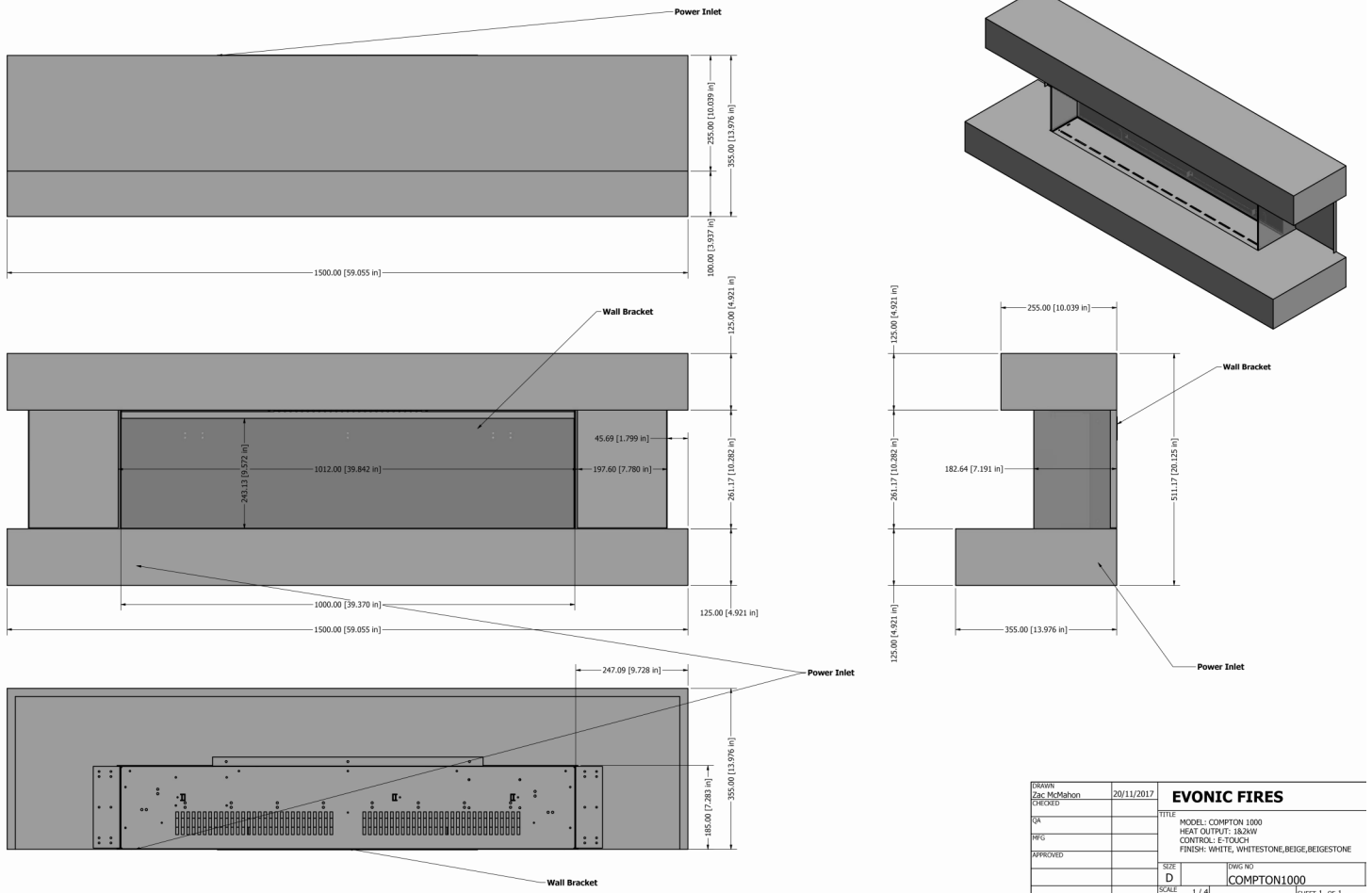

DESIGN	Zac McMahon	20/11/2017	<b>EVONIC FIRES</b>
CHECKED			TITLE
QA			MODEL: COMPTON 1000
RFC			HEAT OUTPUT: 15.0kW
APPROVED			CONTROL: E-TOUCH
			FINISH: WHITE, WHITESTONE, BEIGE, BEIGESTONE
			SIZE
			DWG NO
			COMPTON1000
			SCALE
			1 / 4"
			SHEET 1 OF 1

MODEL	HEIGHT	WIDTH	DEPTH
<b>COMPTON 1000</b>	<b>20 1/8"</b>	<b>59"</b>	<b>14"</b>
	<b>511mm</b>	<b>1500mm</b>	<b>355mm</b>

<b>BOXED WEIGHT</b>	<b>UNBOXED WEIGHT</b>
<b>47KG (104 lbs)</b>	<b>36.55KG (81 lbs)</b>

# Compton 2 Specification:

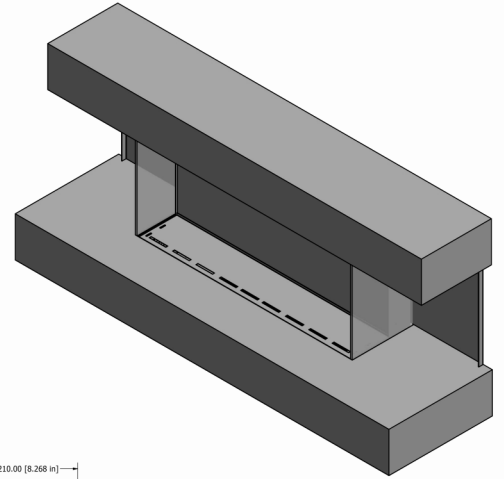
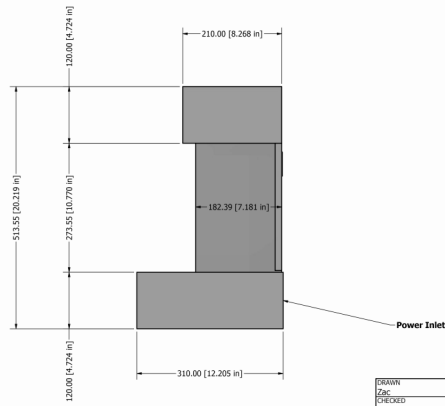
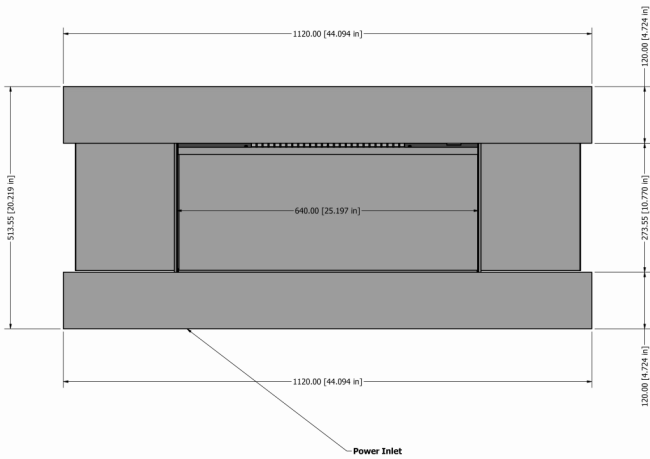
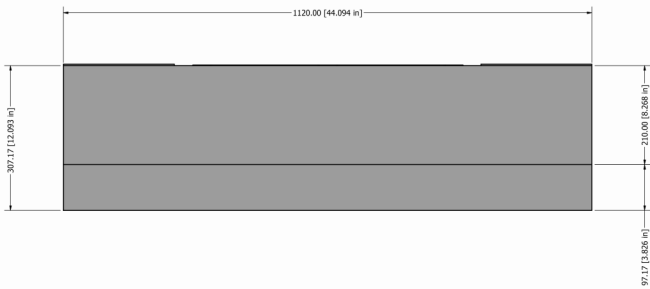

DRAWN	22/07/2019	<b>Evonic Fires</b>
DATE		TITLE
CHECKED		Model: Compton2
QA		
MFG		
APPROVED		
	SIZE	DWG. NO.
	D	COMPTON 2 SPEC

MODEL	HEIGHT	WIDTH	DEPTH
<b>COMPTON 2</b>	20 1/4"	44 1/8"	12 3/16"
	514mm	1120mm	310mm

<b>BOXED WEIGHT</b>	<b>UNBOXED WEIGHT</b>
36KG (79 lbs)	25.55KG (56 lbs)

## Log-Set Guidance:

Model	Log Set/Quantity
Compton 2	E700 Log Set X 1 (5 Logs)
Compton 1000	E1000 Log Set X 1 (6 Logs)

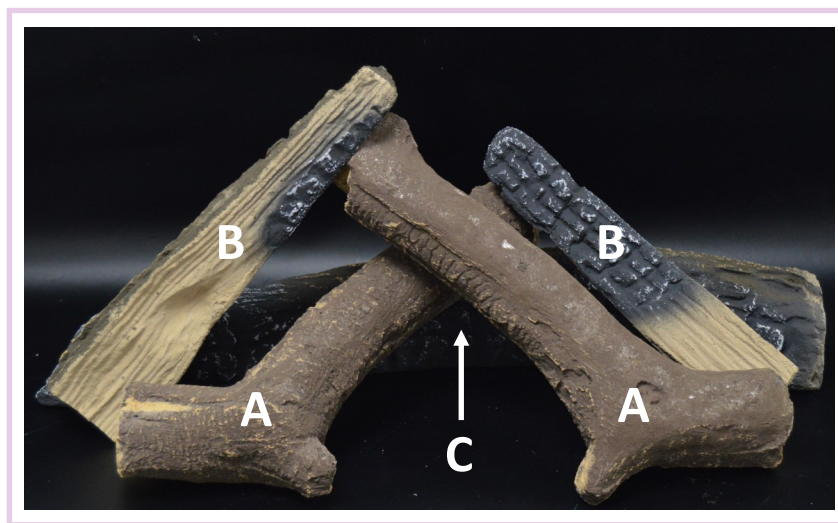

E700 X 1 Log Layout—Applicable with **Compton 2**

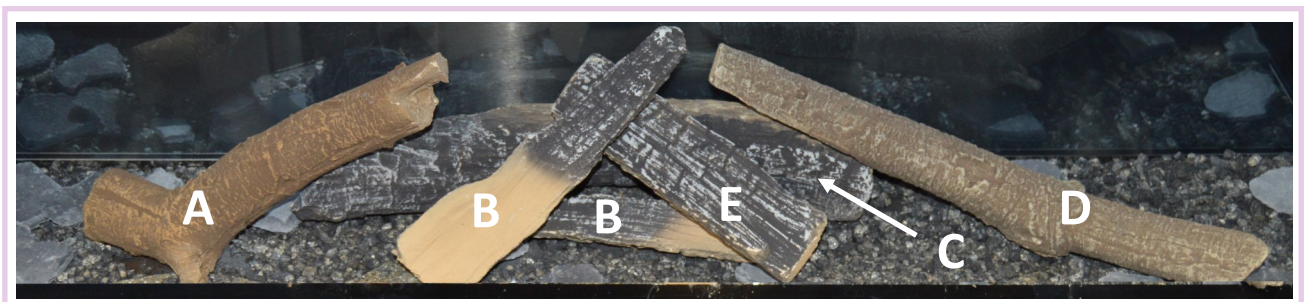

E1000 X 1 Log Layout—Applicable with **Compton 1000**

**Please Note:** The images shown are suggested Log layouts, the log sets can be arranged to personal preference.

# Troubleshooting Flow Chart:

Videos are located in the dealer login:  
<https://europeanhome.com/tech-how-to-videos/>

Problem	Possible Cause	Solution
1)  Flames not working correctly	→ Ribbons are statically connected to glass.	→ Spray some anti-static spray beneath the tray.
	→ Installation airflow restricted.	→ Check the correct aperture has been adhered to when installing— Recommended clearance is 4"(100mm)
	→ Blower clogged.	→ Fan requires cleaning out. <b>Please see Evonic video.</b>
	→ Slow fan.	→ Fan requires cleaning out. If problem persists, replacement fan may be required. <b>Please see Evonic video.</b>
2)  Heater blowing cold	→ Possible installation gaps/Chimney not adequately blocked off.	→ Chimney may not be fully blocked. Correct aperture has not been adhered to— 4"(100mm)
	→ Fan clogged.	→ Heater fan requires cleaning out. <b>Please see Evonic video.</b>
	→ Faulty element.	→ Replace element. <b>Please see Evonic video.</b>
	→ Slow fan.	→ Check fan placement. If problem persists replacement fan may be required. <b>Please see Evonic video.</b>

## Problem

## Possible Cause

## Solution

3)

Noisy Heater

Fan unbalanced.

Adjust fan to stop catching on the case. If problem persists replacement fan unit maybe required. **Please see Evonic video.**

Fan catching on housing.

Adjust fan to stop catching on the case. **Please see Evonic video.**

Fan clogged.

Fan requires cleaning out. If problem persists a replacement fan may be required. **Please see Evonic video.**

Fan has come loose.

Tighten fan cradle or screws holding fan onto fan cradle. **Please see Evonic video.**

4)

Noisy Flame Effect

Fan unbalanced.

Adjust fan to stop catching on the case. If problem persists a replacement fan unit may be required. **Please see Evonic video.**

Fan catching on housing.

Adjust fan to stop catching on the case. **Please see Evonic video.**

Fan clogged.

Fan requires cleaning out. If problem persists a replacement fan may be required. **Please see Evonic video.**

Fan has come loose.

Tighten fan cradle or screws holding fan onto fan cradle. **Please see Evonic video.**

**Problem**

**Possible Cause**

**Solution**

5)  
  
Fire not turning on.

→ Rocker switch has not been turned to the 'ON' position.

→ Double check switches are turned to the 'ON' position.

→ Remote/App not paired.

→ Remote / App needs pairing. See pages 18-19 for instructions

→ Fuse blown.

→ Replace fuse.

→ Unit not plugged in correctly.

→ Check to be sure the power lead is plugged in adequately.

6)  
  
No lights

→ Loose connection or disconnected wire.

→ Check all connections on LED's. **Please see Evonic video.**

→ LED shorting out

→ Check location of short—Replace LED strip if necessary. **Please see Evonic video.**

→ LED blown

→ LED strip needs replacing. **Please see Evonic video.**

→ Blown driver on PCB

→ PCB needs replacing. **Please see Evonic video.**

Problem	Possible Cause	Solution
7) Heater coming on randomly	→ Timer has been accidentally set.	→ Double check timer settings.
	→ Thermostat faulty.	→ Replace PCB. <b>Please see Evonic video.</b>
8) LED streaking	→ LED dropped down.	→ LED needs to be re-stuck into place.
	→ Log positioning.	→ Change log positioning to hide any direct view of LED strip.
9) Heater cutting out	→ Build up of hot air triggering heater cut-out unit.	→ Ensure the appliance has the required aperture for air to circulate and prevent build-up. Recommended <b>4" (100mm)</b>
10) Noisy fans	→ Fan has slipped off-centre of mechanism	→ Press red button on side of fan to re-centre to stop it from catching. <b>Please see Evonic video.</b>



## E-Tab Controller

1.

2.



1. Volume control
2. Power button—Press and hold for 3 seconds to turn **ON/OFF**

The e-touch app can be used with both smart phone and tablet devices.

Utilising the e-touch app will allow complete controllability of your European Home product.

To download the e-touch app please follow the below steps.

**PLEASE NOTE: e-tab control systems already come with e-touch app installed**

**PLEASE NOTE: Once fully charged, the battery life of the E-tab control system is roughly 24 hours and needs daily charging.**

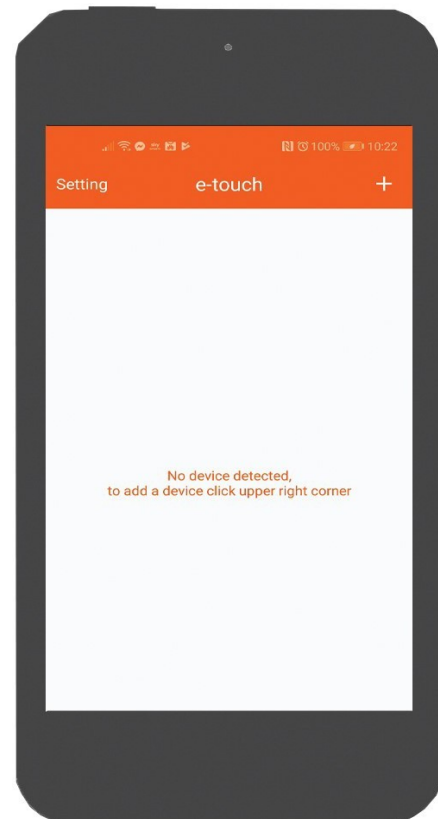
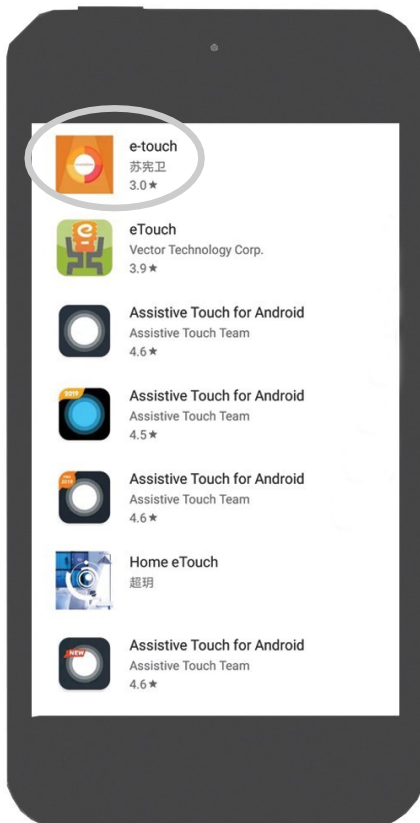

1) Access either the Apple app store or Google play, this is depending on the operating system of your smart phone or tablet.

2) Search, locate, and download the app entitled e-touch

3) Open the (e-touch) App and the above screen will appear.

4) To ADD your product, simply click the + button at the top right of the screen.

The e-touch App will then begin to scan for your European home product.

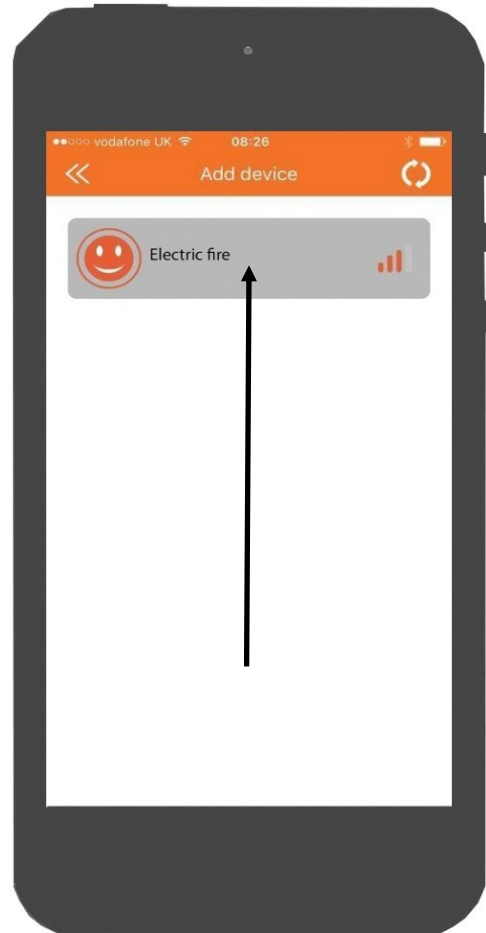
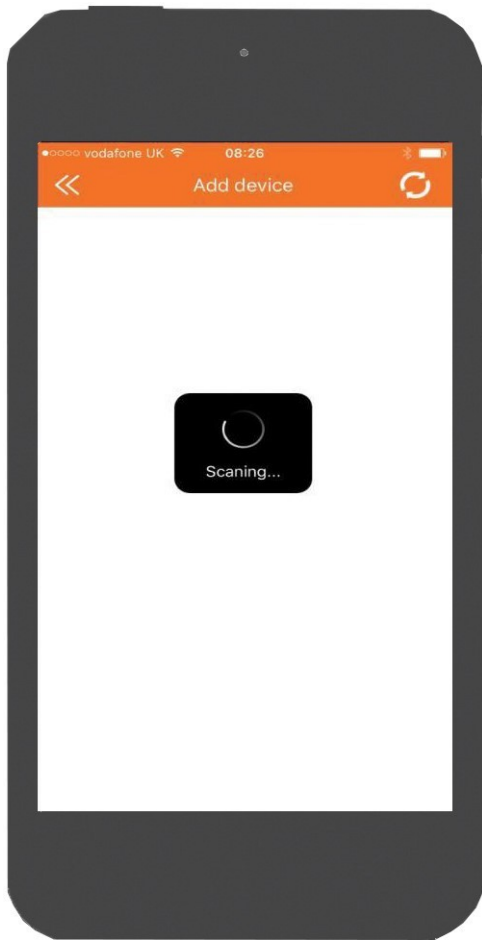

**Please note:** *To enable the e-touch app to find/ discover your European Home product, the smart*

*phone or tablet must be no more than a foot away from the product).*

*To ensure successful pairing*

*please hold your device toward the bottom right hand side of the fire.*

5) Once the e-touch App has discovered your product, the above screen will appear.

6) To connect your fireplace simply click on the fireplace icon.

7) Your product will now be paired and ready to operate.

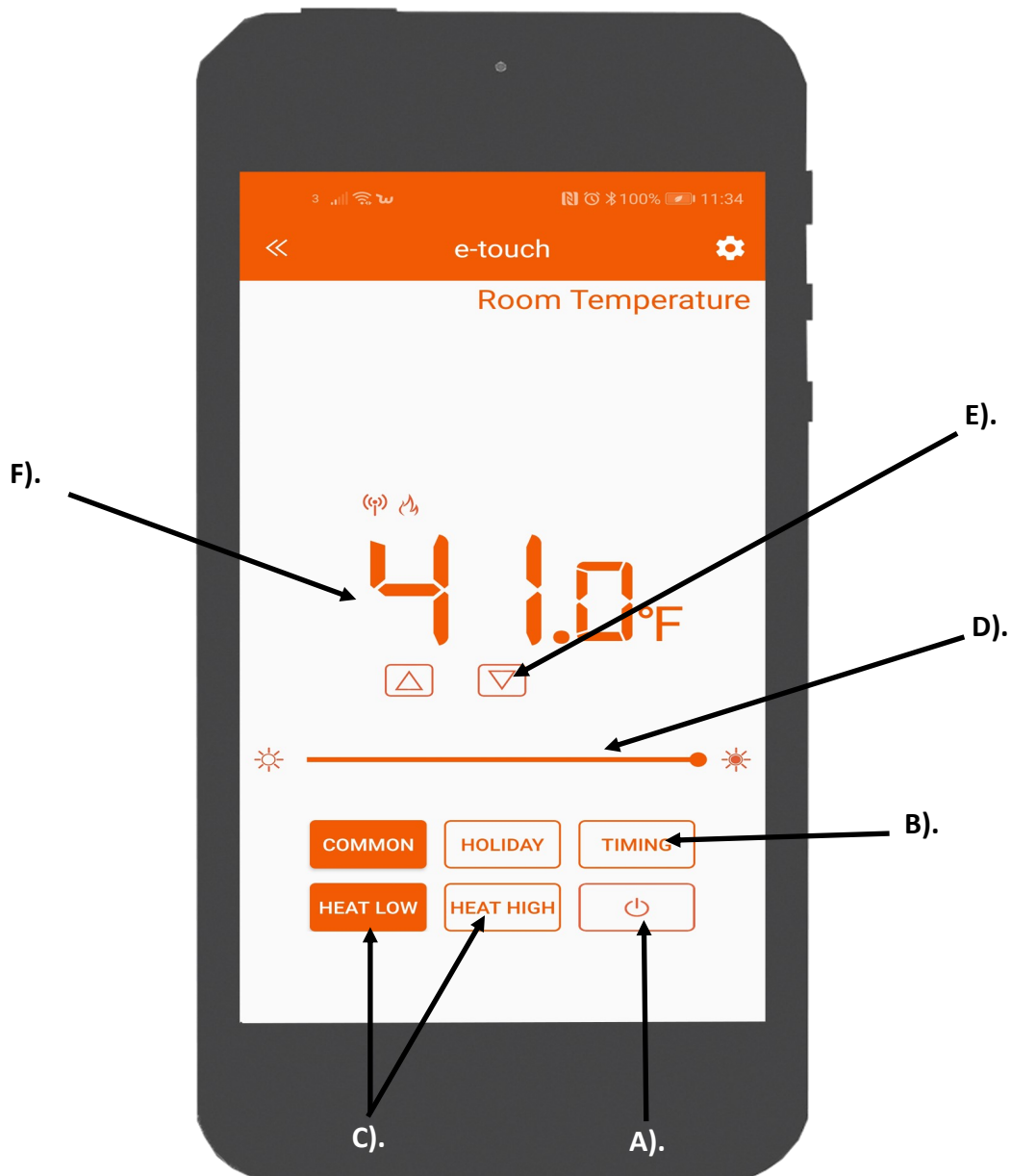

A) ON & OFF key—Single press to turn product on or off.

B) Setup/Seven day programable timer keys—Used to navigate timer options

C) Heat high/heat low keys—Single press to select 750 or 1.5KW of heat output.

D) Dimmer keys—Single press to increase or decrease the brightness of flame effect.

E) Temperature control keys—Single press to increase or decrease temperature when setting desired room temperature. **(Please note to activate the heater the temperature must be set higher than the ambient room temperature. To de-activate the heater the temperature must be set lower than the ambient room temperature).**

F) Room temperature display—This displays the desired room temperature

**PLEASE NOTE:** The 7 day timer is only active when 'Week' or 'Holiday' is highlighted

## Programming the seven day timer:

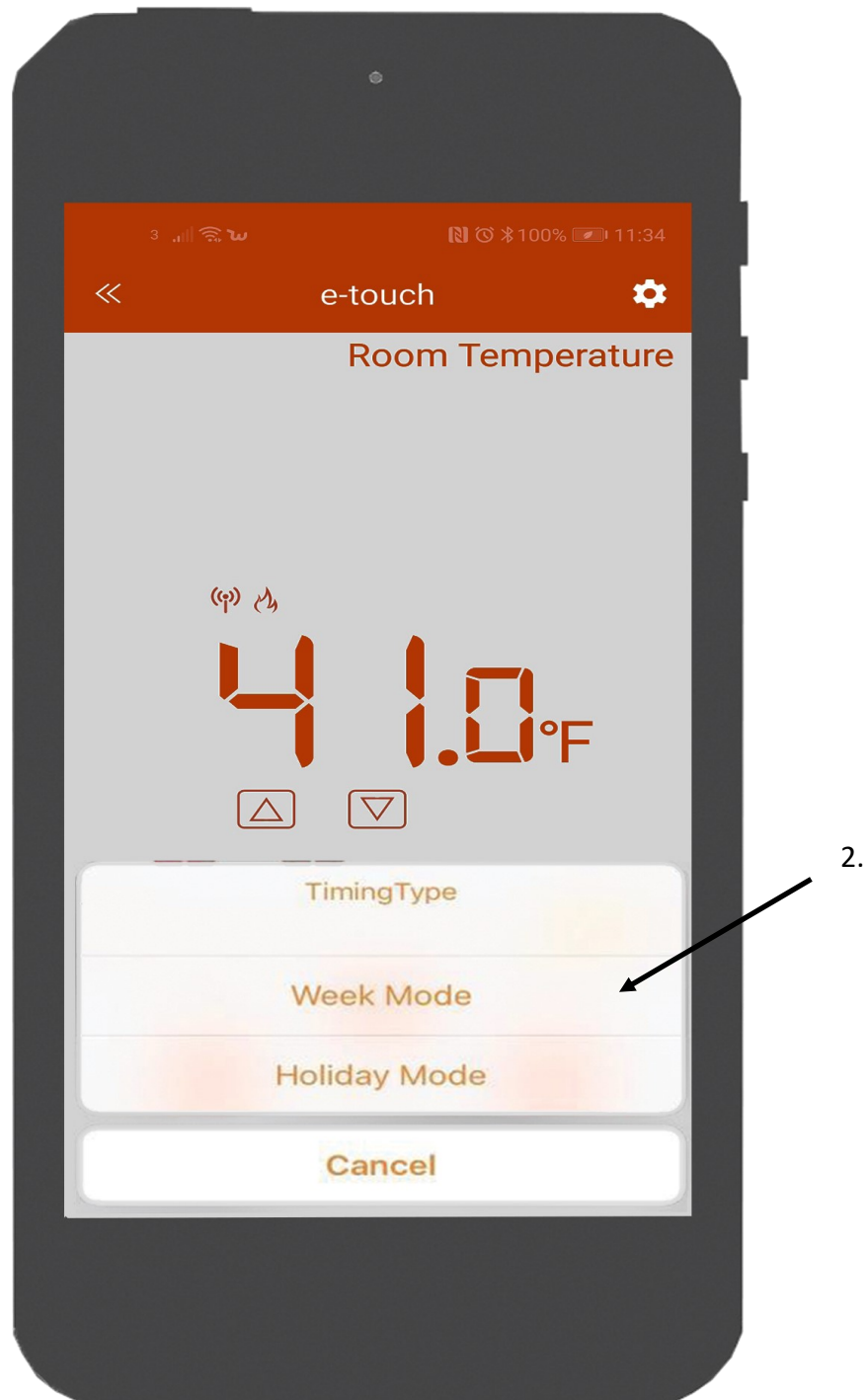

To access the program the 7 day programmable timer please follow the below steps.

1. Click the 'TIME SET' button on the home screen, and the above image will appear.
2. Click the 'WEEK MODE' button and the timer summary screen will appear, see over page.

## Timer Summary Screen:

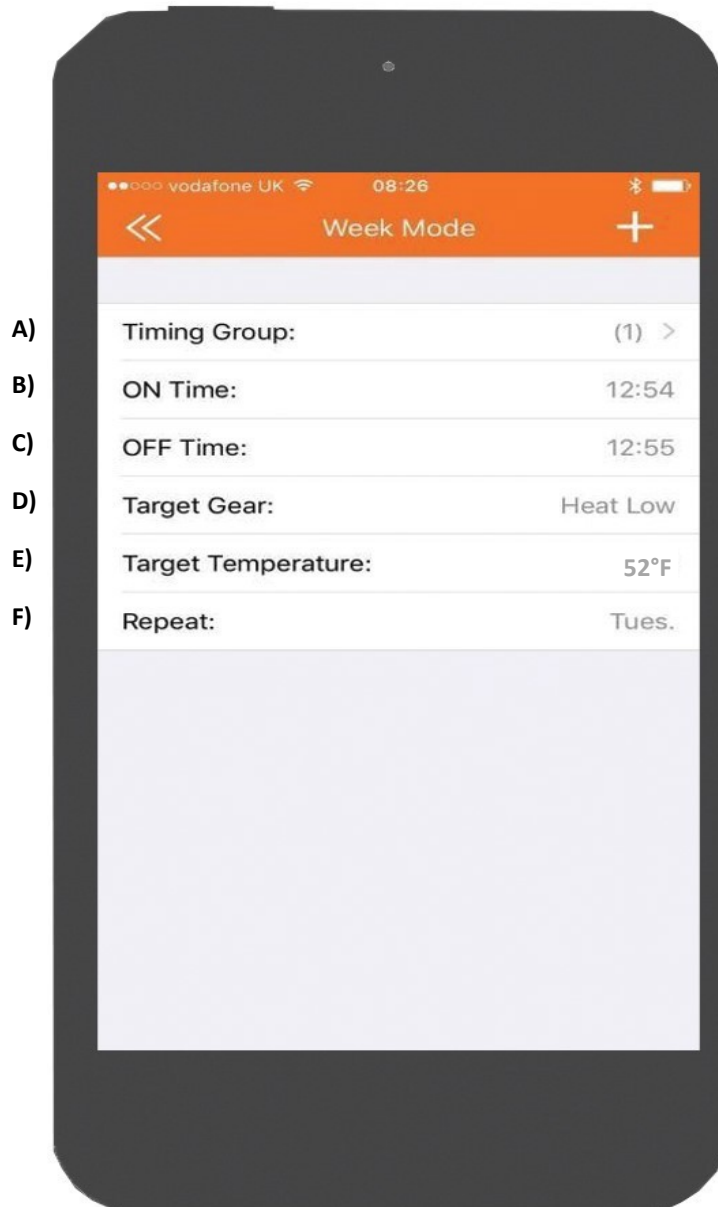

A) Timer group—click to add one or more timing groups or weeks

B) On time—Click to set a time for the heater to switch on (ON)

C) Off time—Click to set a time for the heater to switch off (OFF)

D) Target Gear—Click to set the heater to switch on Heat low or High

E) Target temperature—Click to set what temperature you would like the program to reach before the thermostat is activated.

F) Repeat—Click to set what day(s) you would like the program to repeat.

## Programming the 7 day timer continued:

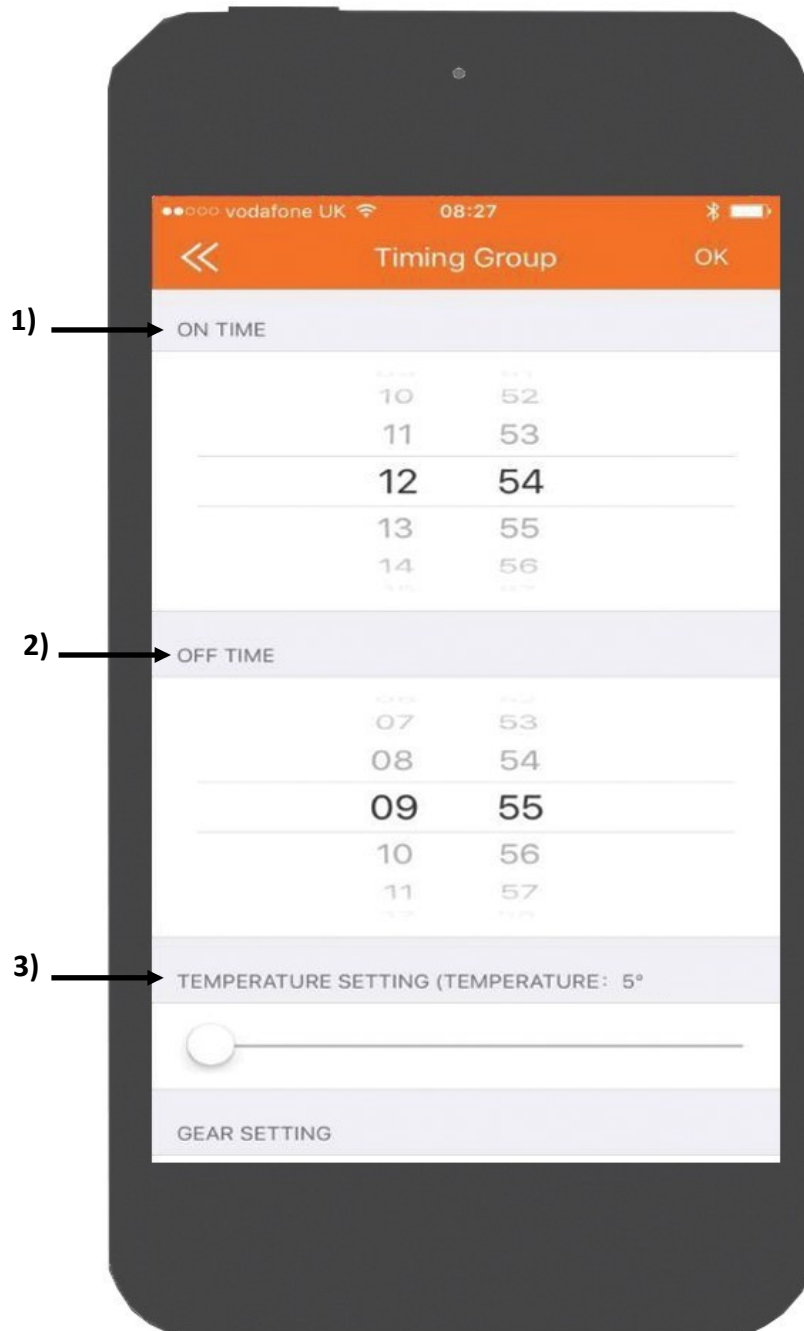

To set a timing program please follow the below steps:

1. Select the time on which you would like the heater to activate.
2. Select the time on which you would like the heater to de-activate.
3. Select the temperature you would like the heater to activate at.

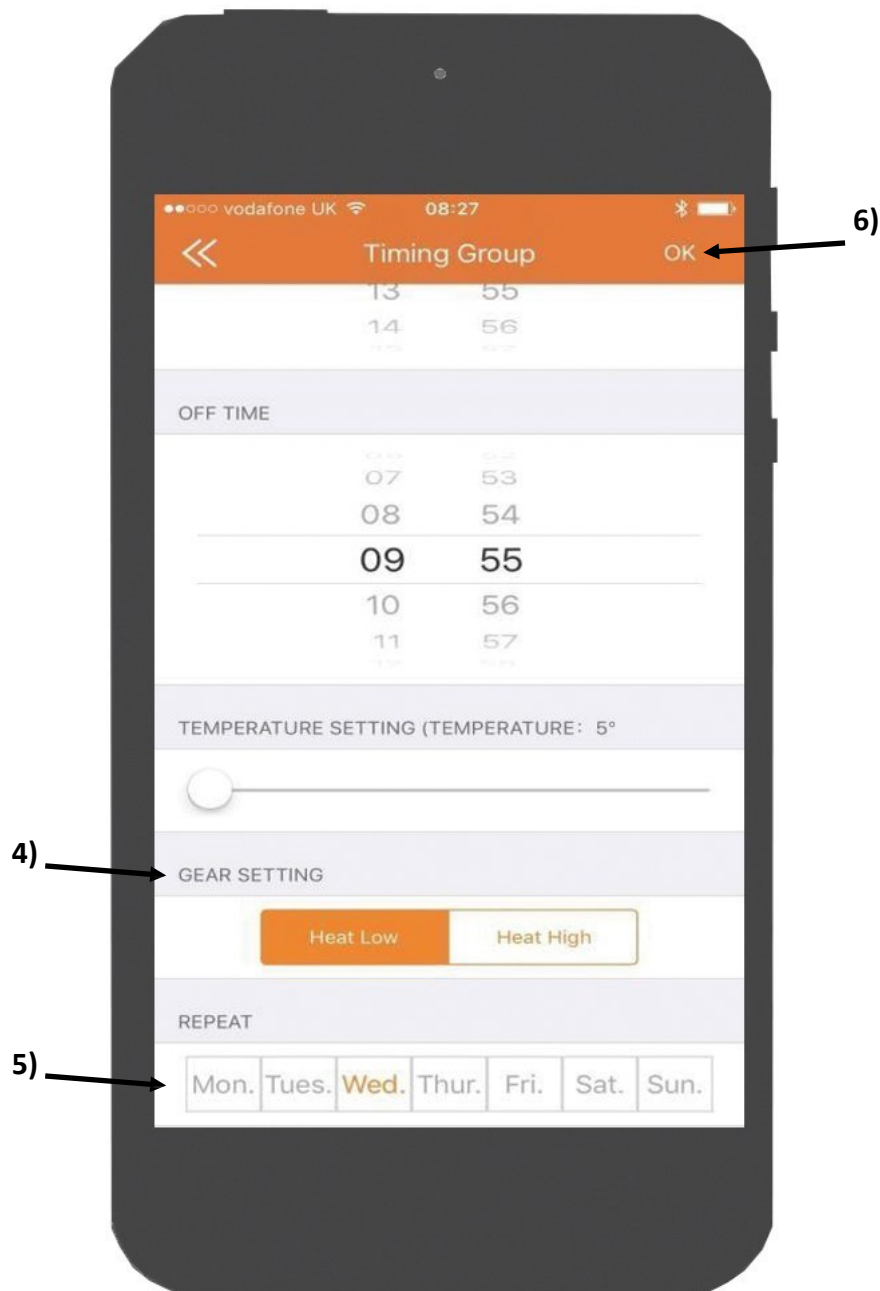

4. Select the gear setting or power on which power you would like the heater to activate on (heat low—1kw) or (heat high—2kw).

5. Select on which day or days you would like your timing program to activate or repeat.

6. To confirm your timing program click OK.

7. Ensure that the 'WEEK' button is highlighted on the home screen to activate your timing program.

**Once you have activated your timing program, this can be bypassed by highlighting the 'HOLIDAY' button on the home screen.**



# Changing units of temperature:

1.

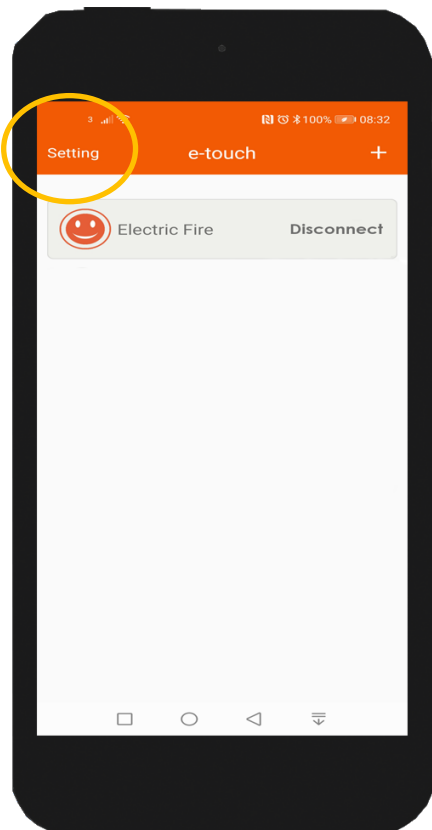

2.

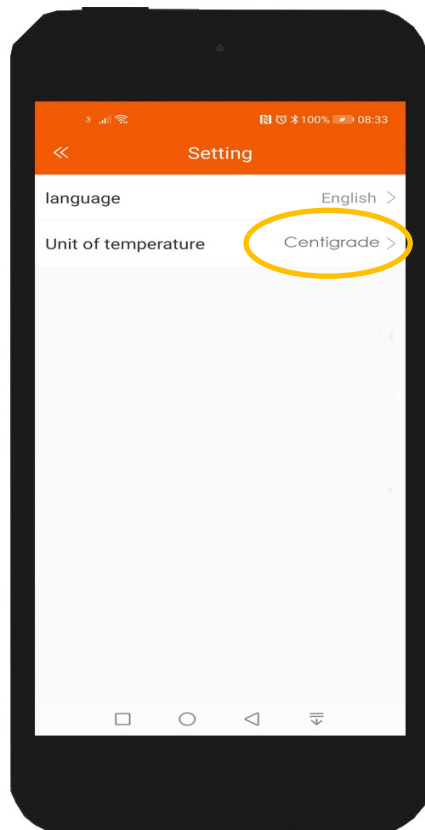

3.

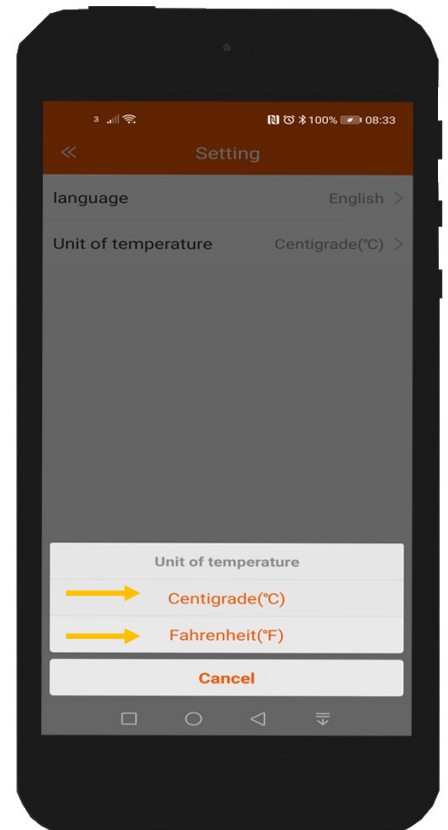

1. On the app home screen, in the top left corner you will see the setting icon. Press to open.
2. You will then see the 'Unit of temperature' option. Press to open the selection panel.
3. You will then be able to select your preferred unit of temperature.



## **European Home Warranty**

European Home Warranty Electric Modern Family of Products European Home warrants all Electric Modern electric fireplaces against defects in materials and workmanship for a period of TWO (2) YEARS from the date of original retail purchase. If a defect exists, European Home will, at its option, either (1) repair the product at no charge, using new or refurbished re-placement parts or (2) exchange the product with one which is new or which has been manufactured from new or serviceable used parts and is at least functionally equivalent to the original product. A replacement product/part assumes the remaining warranty of the original product or ninety (90) days from the date of replacement or repair, whichever provides longer coverage for you. When a product or part is exchanged, any replacement item becomes your property and the replaced item becomes the property of European Home. Nothing in the above shall be deemed to imply that this warranty shall apply to work which has been abused or neglected or shows evidence of changes or modifications by others with or without permit, damages caused by the acts of God, building settlement or moving, fire or vandalism. In addition, installation of this product that varies from the requirements stated in the instruction manual will void the warranty.

**European Home  
30 Log Bridge Road  
Bldg 300, Unit 303  
Middleton, MA 01949  
United States**