

**BODY
CHAMP**®

PT620
VKR1808

MULTIFUNCTION VKR
POWER TOWER

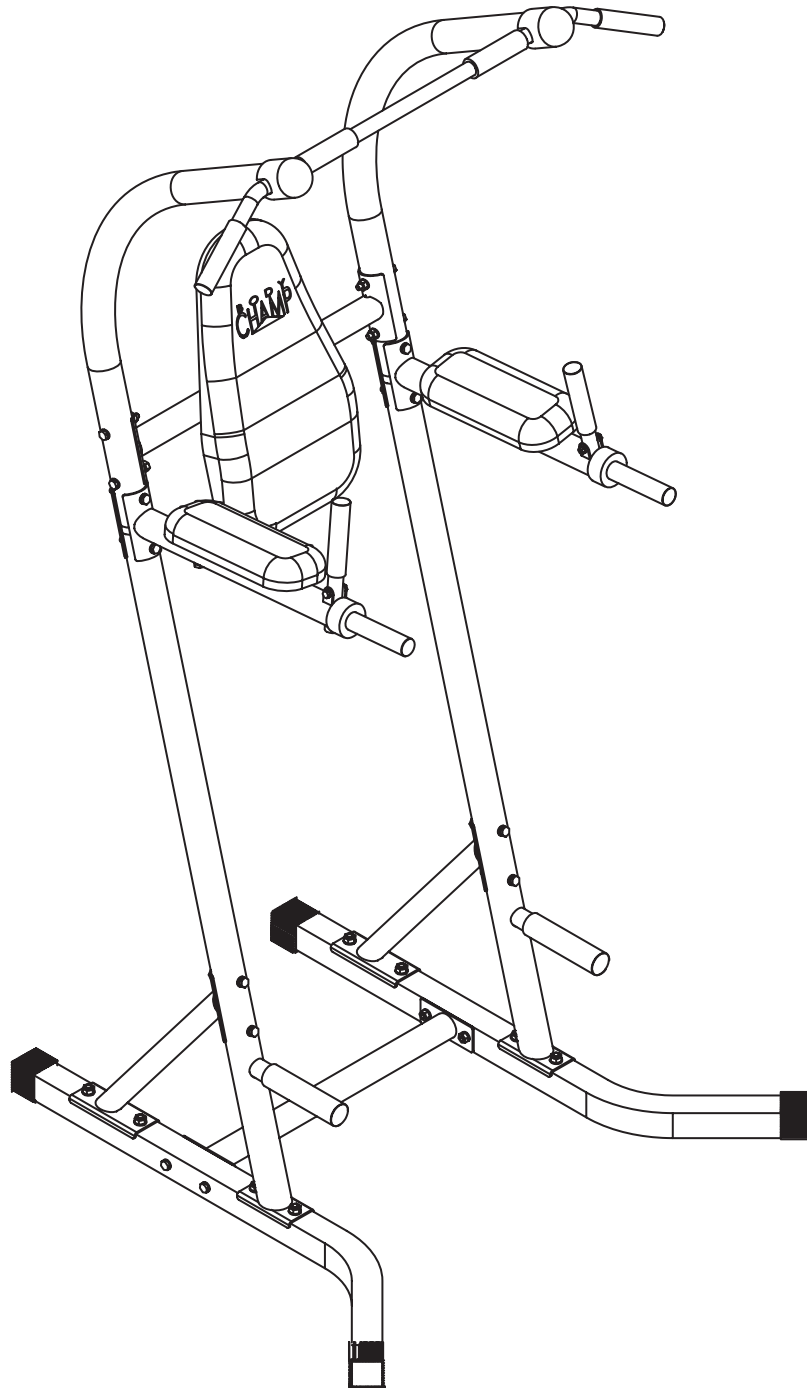

This product is intended for indoor, home use only and is not to be used in a commercial setting.

OWNER'S MANUAL

**PLEASE KEEP THESE INSTRUCTIONS FOR FUTURE USE & REFERENCE.
DO NOT DISCARD.**

WARNING: SERIOUS INJURIES AND EVEN DEATH CAN OCCUR IF THE PROPER SAFETY PRECAUTIONS ARE NOT FOLLOWED.

The diagram below highlights and reviews many of the important Safety and Warning labels also found on the unit. Please ensure any user of the unit familiarizes themselves with these Safety and Warning guidelines before use.

⚠ WARNING !

The use of this exercise equipment involves a **RISK OF PHYSICAL INJURY** as well as property damage, which can be minimized by observing the following guidelines:

1. Thoroughly inspect equipment before each workout. Check all nuts, bolts, screws and pop pins to be in place and fully tightened. Also, if included, check cables for signs of wear. Replace all worn parts before exercising. Never use the machine if any parts are damaged or missing. Failure to follow these rules may result in serious injury.
2. Keep body, hair and clothing free and clear of all moving parts.
3. Exercise carefully and with caution; you use this product at your own risk. Perform your exercises at a moderate pace; never perform jerky or uncoordinated movement that may cause injury. It is recommended that you should work out with a partner.
4. Do not allow children or minors to play on or around this equipment. Teenagers using strength equipment should be supervised by an adult.
5. Read and understand all instructions & warnings stated in the Owner's Manual as well as on the equipment before exercising.
6. **WARNING :** You should consult your physician before starting any exercise regimen. For your own safety, do not begin any exercise program without proper instructions.
7. The equipment is not to be used in a commercial setting. This product is intended for indoor, home-use only.
8. Replace label if damaged, illegible or removed.
9. This item meets ASTM F2216 standards for fitness equipment.
10. Maximum weight capacity : 250 lbs. User weight

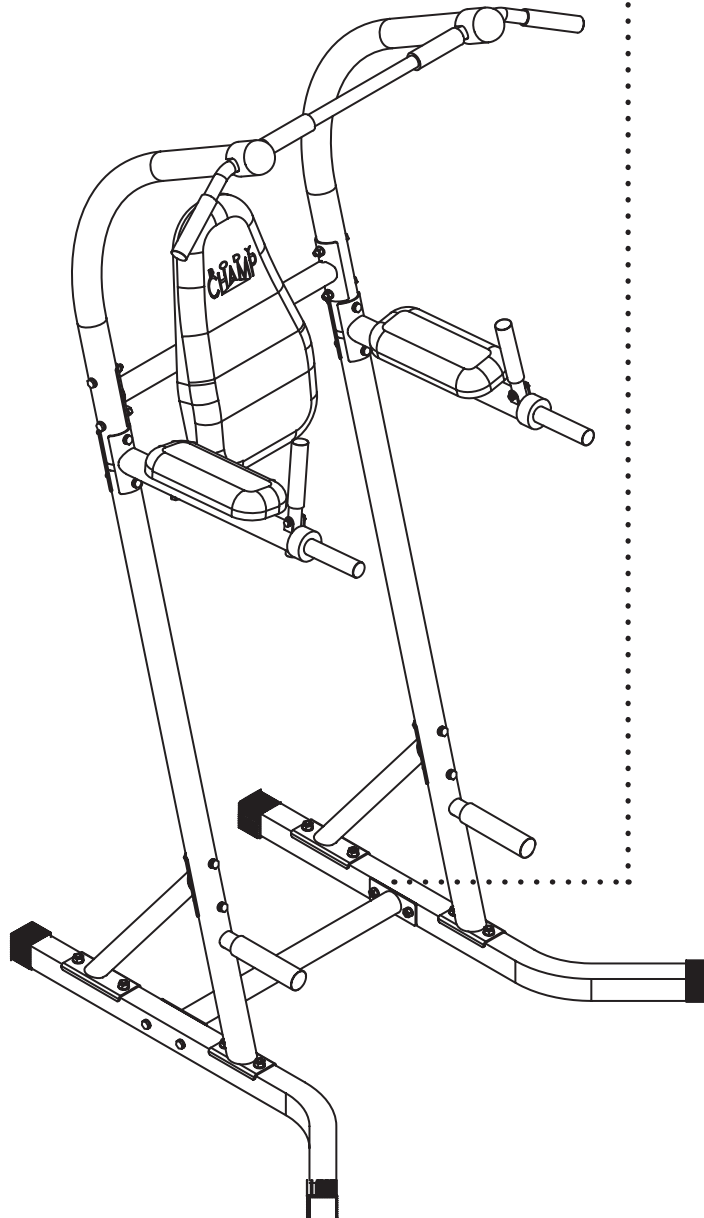

General Information

Safety

Before you undertake any exercise program, please be sure to consult with your doctor.

Frequent strenuous exercise should be approved by your doctor and proper use of your product is essential.

Excessive or incorrect training may result to health injuries.

Please read this manual carefully before commencing the assembly of your product or starting to exercise.

- Please keep all children away from this item when in use. Do not allow children to climb or play on this item when it is not in use.
- Supervise teenagers while they use this unit.
- For your own safety, always ensure that there is at least 3 feet of free space in all directions around your product while you are exercising.
- Regularly check to see that all nuts, bolts and fittings are securely tightened. Periodically check all moving parts for obvious signs of wear or damage.
- Any adjustment devices that could interfere with the user's movement on this unit should not be left projecting.
- Clean only with a damp cloth, do not use solvent cleaners.
If you are in any doubt, do not use your product; contact CUSTOMER SUPPORT.
- Before use, always ensure that your product is positioned on a solid, hard-flat surface.
- Do not place on carpet. If necessary, use a rubber mat underneath to reduce the possibility of slipping.
- Always wear appropriate clothing and footwear such as training shoes when exercising. Do not wear loose clothing that could become caught in moving parts during exercise.
- Do not use this unit if it is not functioning properly or if it is not fully assembled.
- Do not use this unit for commercial purposes. This unit is for home use only.
- Before use, you must read and understand all instructions & warnings stated in this Owner's Manual as well as posted on the equipment.
- It is the facility owner's responsibility to properly instruct users on the proper operation of the equipment and to warn them of the potential hazards.
- If at any time during exercise you feel faint, dizzy or experience pain, stop and consult your physician.

Weight Limit

Maximum Weight Limit is 250 lbs for user weight.

Storage and Use

Your product is intended for use in clean dry conditions. You should avoid storage in excessively cold or damp places as this may lead to corrosion and other related problems.

Warranty

Hupa International, Inc. warrants your product for a period of 1 year for the frame and 90 days on all parts if the item is used for the intended purpose, properly maintained and not used commercially.

Any alterations or incorrect assembly of the product will void this warranty.

Proof of purchase must be presented for any warranty validation (no exceptions). This warranty applies to the original purchaser only and is not transferable.

This warranty does not cover abuse or defects caused during use, storage or assembly. During the warranty period, Hupa International, Inc. reserves the right to:

1. provide replacement parts to the purchaser in an effort to repair the item.
2. repair the product returned to our warehouse (at the purchaser's cost).
3. replace the product if neither of the two previously mentioned actions effect repair. This warranty does not cover normal wear and tear on upholstery.

Questions

If you have any questions concerning the assembly of your item or if any parts are missing, please **CONTACT OUR CUSTOMER SUPPORT TEAM DIRECTLY FOR ACCURATE AND EXPEDITED ASSISTANCE; DO NOT RETURN** the item to the store or contact the retailer which may likely cause delays in support to you.

Our dedicated customer service staff can help you with any questions you may have regarding the assembly of this unit and can also mail you replacement parts.

Customer Support

Customer Support is open 9:00 a.m. to 5:00 p.m. (Pacific Time) Monday through Friday.

Please contact us by any of the following methods :

Hupa International, Inc.
21717 Ferrero Parkway
Walnut, CA 91789

Telephone: 1 (888) 266 - 6789
Fax: 1 (909) 598 - 6707
Email: info@hupa.net

Before Assembly

⚠ WARNING

1. Take a few minutes to familiarize yourself with the parts and hardware included with your product.
2. Assembly may require two people.
3. Check the frame for any damage and check any wiring (if present) for rips or tears. If you detect damage, rips, or tears, please contact our Customer Support Team before beginning any assembly.
4. Make sure all the hardware needed is included.
5. It is very important to follow the assembly instructions correctly and to make sure all parts are attached correctly and firmly tightened when the assembly process is complete.
6. Parts that are not tightened correctly will seem loose and can cause irritating noises and will cause damage to the equipment.

PLEASE NOTE : Some of the parts and hardwares listed on the parts list may already pre-assembled or installed on the unit.

Nylon Lock Safety Nuts

1. It is only necessary to tighten the bolts and nuts to “finger tight” during the assembly process. This will make it easier to complete certain steps by allowing more tolerance for all the parts to fit properly.
2. Do not tighten all the nuts onto the bolts securely until after you have completed assembly of your product.
3. Use wrenches, pliers, or ratchet and sockets to tighten the bolts and nuts.
4. The Nylon Nut should thread onto the Hex Bolt until the end of the Hex Bolt has passed through the Nylon insert inside the Nut. Please follow this guideline everytime you see this *Nylon Nut icon* throughout the assembly steps.

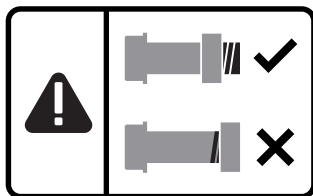

Tools Required For Assembly

Tool	Description/Purpose
Ruler (with both Metric and English measurements) QTY: 1	Use to measure the length or size of hardware including bolts to ensure you are using the correct part.
Adjustable or flat wrenches QTY: 2	Use to securely install parts including nuts and bolts.

Hardware and Tool List

Bolts

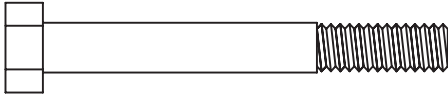

#13. Bolt (M8x65 mm) [4 pieces]

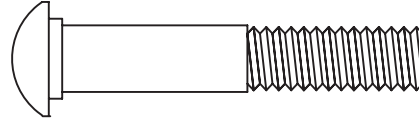

#16. Carriage Bolt (M10x65 mm) [8 pieces]

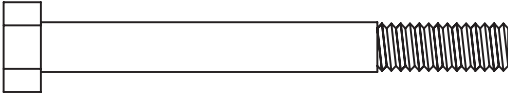

#19. Bolt (M8x70 mm) [12 pieces]

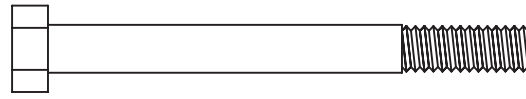

#25. Bolt (M8x75 mm) [4 pieces]

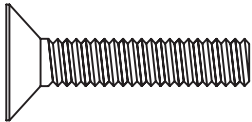

#28. Screw (M8x35 mm) [2 pieces]

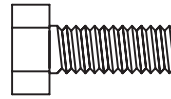

#30. Bolt (M8x20 mm) [2 pieces]

Washers

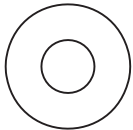

#14. Washer (M8) [10 pieces]

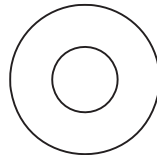

#17. Washer (M10) [8 pieces]



#20. Curved Washer (M8) [26 pieces]

Nuts



#15. Lock Nut (M8) [14 pieces]



#18. Lock Nut (M10) [8 pieces]

Assembly STEP 1

Align and attach the Base Frame (Right) (#02) to the Base Cross Frame (#03) as illustrated in the diagram. Insert two Bolts (#13) through two Washers (#14) followed by the Base Frame (Right) (#02) and Base Cross Frame (#03). Secure them together using two Washers (#14) and two Lock Nuts (#15). Repeat this process on the other side.

NOTE:

To avoid misalignment due to over-tightening, please do not use a wrench at this time. Hand-tightening for now will help ensure easy assembly.

Wrench-tightening should be performed after all parts are assembled to ensure all nuts, bolts, and parts are tightly secured before use.

Hardware Required

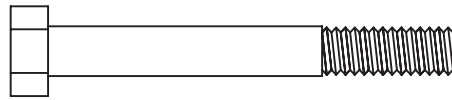

#13. Bolt (M8x65 mm) [4 pieces]

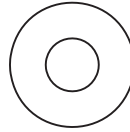

#14. Washer (M8) [8 pieces]



#15. Lock Nut (M8) [4 pieces]

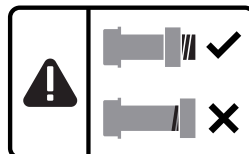
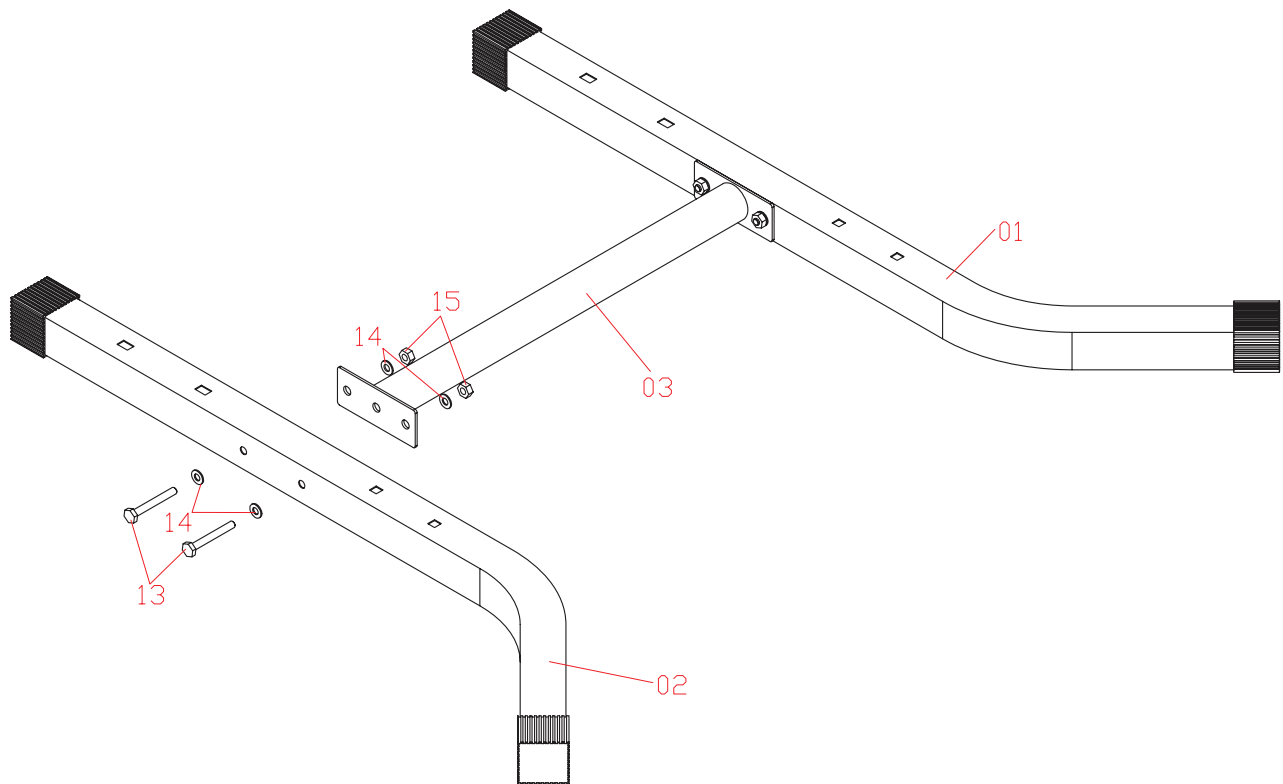

Assembly STEP 2

With the help of an assistant, align and attach the Upright (#05) to the Base Frame (Right) (#02). Insert two Carriage Bolts (#16) through the Base Frame (Right) (#02) and Upright (#05). Secure them together using two Washers (#17) and two Lock Nuts (#18). Repeat this process on the other side.

Align and attach the Upright Angle Support Frame (#04) to the Upright (#05) and Base Frame (Right) (#02). Insert two Carriage Bolts (#16) through the bottom of the Base Frame (Right) (#02) followed by the Upright Angle Support Frame (#04).

At this point hand tighten the two Washers (#17) and two Lock Nuts (#18) on the lower portion as it may be difficult to align the holes for the upper portion. Insert two Bolts (#19) through two Curved Washers (#20) followed by the Upright (#05), and Upright Angle Support Frame (#04). Secure them together using one Curved Washer (#20) and one Lock Nut (#15). Repeat this process on the other side.

Now secure the Lock Nuts (#18) that were hand tightened in the lower portion. Repeat this process on the other side.

Hardware Required

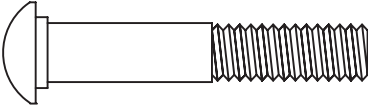

#16. Carriage Bolt (M10x65 mm) [8 pieces]

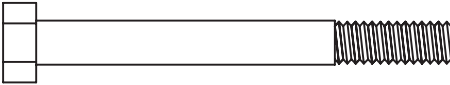

#19. Bolt (M8x70 mm) [4 pieces]

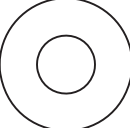

#17. Washer (M10) [8 pieces]



#20. Curved Washer (M8) [6 pieces]



#15. Lock Nut (M8) [14 pieces]

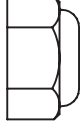

#18. Lock Nut (M10) [8 pieces]

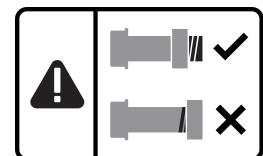
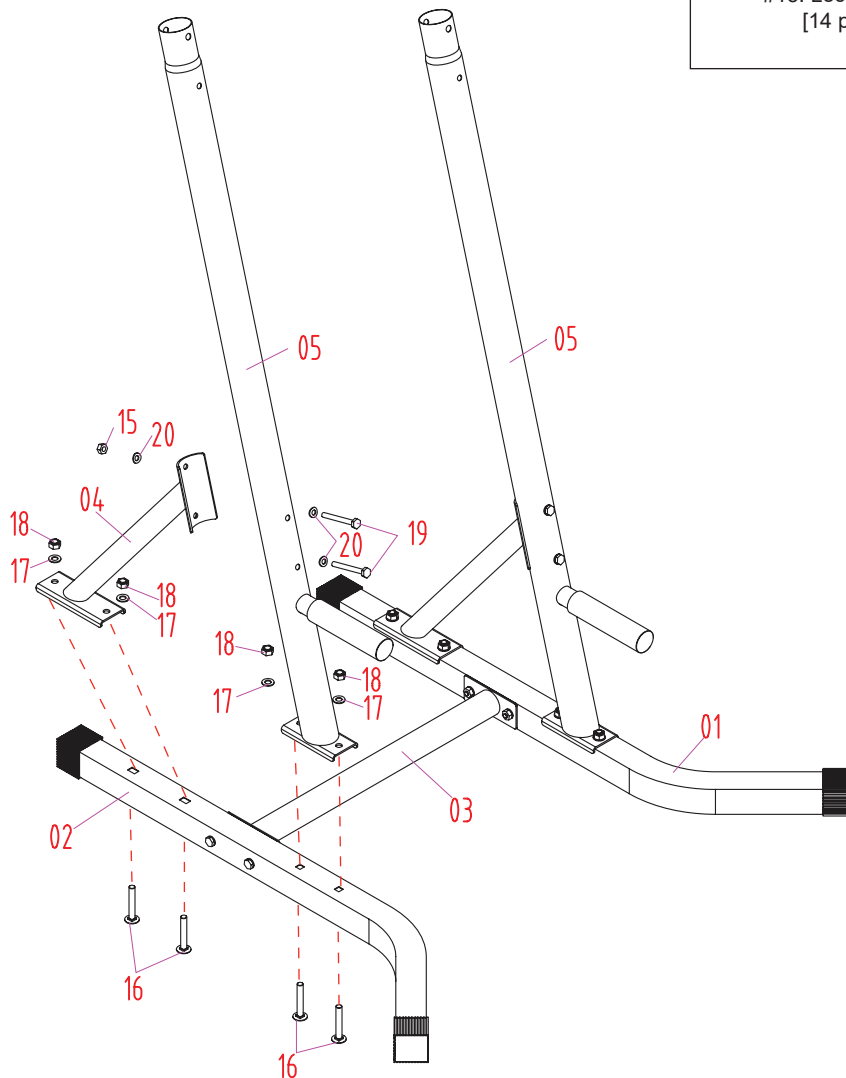

Assembly STEP 3

Align and attach the L Shaped Upper Frame (#06) to the Back Pad Support Frame (#07) as illustrated in the diagram. Insert two Bolts (#19) through two Curved Washers (#20) followed by the L Shaped Upper Frame (#06) and Back Pad Support Frame (#07). Secure them together using two Curved Washers (#20) and two Lock Nuts (#15). Repeat this process on the other side.

Insert the Pull Up Handlebar (#10) into both L Shaped Upper Frame (#06) and secure it using two Screws (#28) directly into the L Shaped Upper Frame (#06) as illustrated. Slide the Upper Frame End Cap (#31) over the Pull Up Handlebar (#10) and both the L Shaped Upper Frames (#06).

Hardware Required

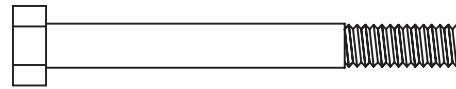

#19. Bolt (M8x70 mm) [4 pieces]

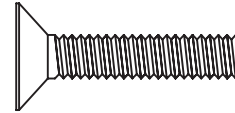

#28. Screw (M8x35 mm) [2 pieces]



#20. Curved Washer (M8)
[8 pieces]



#15. Lock Nut (M8)
[4 pieces]

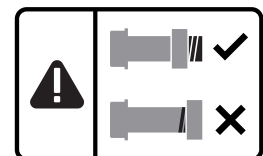
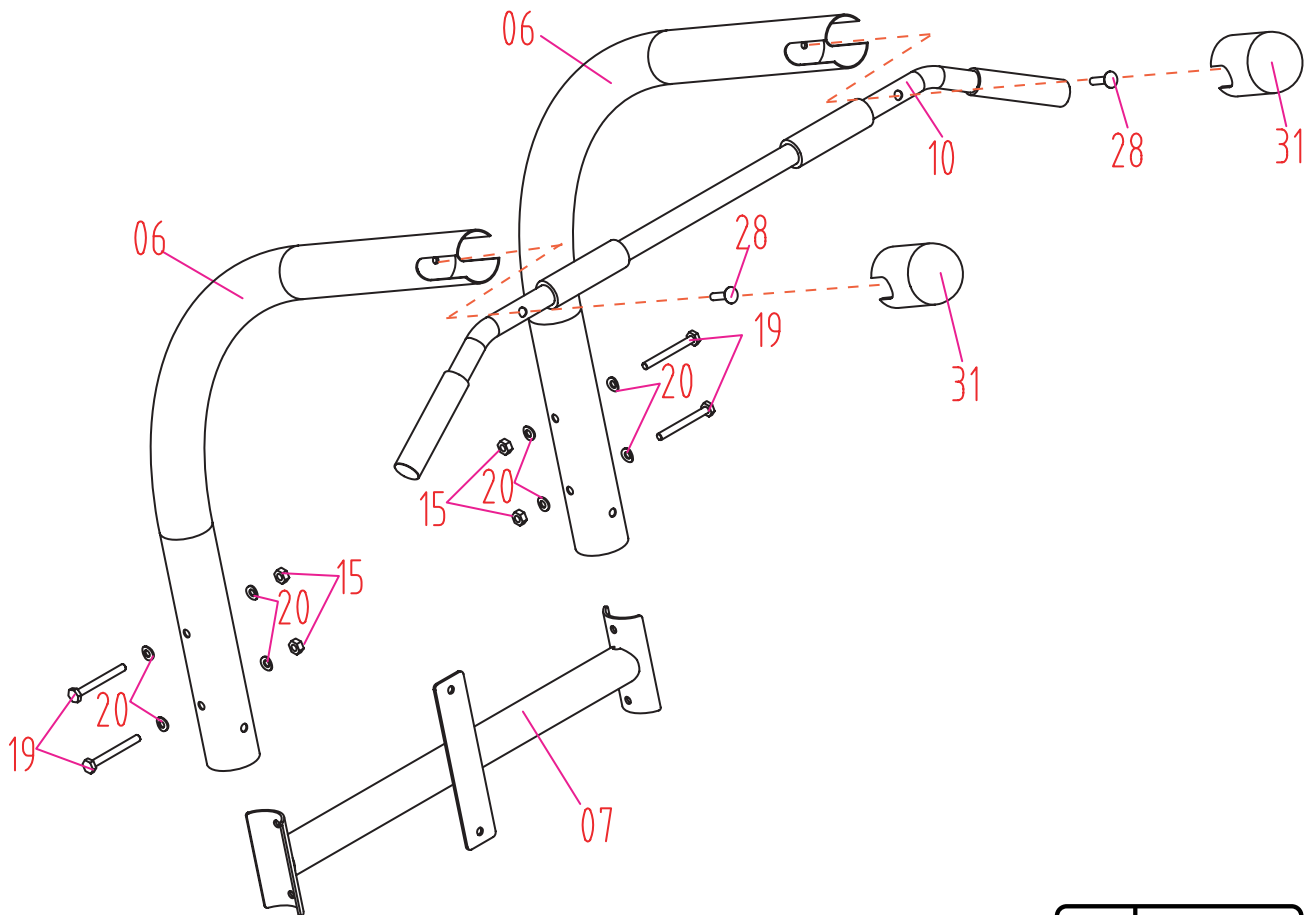

Assembly STEP 4

With the help of an assistant, slide the L Shaped Upper Frames (#06) into the Uprights (#05) as oriented in illustration indicated below. Insert two Bolts (#25) through two Curved Washers (#20) followed by the VKR Arm Rest Support

Frame-Right (#34), L Shaped Upper Frame (#06), Upright (#05) and Curved Shaped Metal Plate (#27). Secure them together using two Curved Washers (#20) and two Lock Nuts (#15). Repeat this process on the other side. Next, to properly assemble the VKR Handlebar (#08), please lift the right VKR Handlebar (#08) so that it is vertically perpendicular to the two holes on the VKR Arm Rest Support Frame-Right (#34).

Insert the VKR Handlebar (#08) down through both holes. Please jiggle the VKR Handlebar (#08) a little to ensure it is fully inserted. Repeat on the opposite side.

Hardware Required

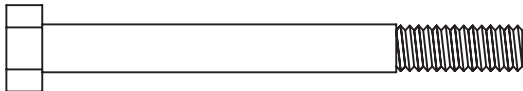

#25. Bolt (M8x75 mm) [4 pieces]

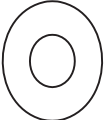

#20. Curved Washer (M8) [8 pieces]



#15. Lock Nut (M8) [4 pieces]

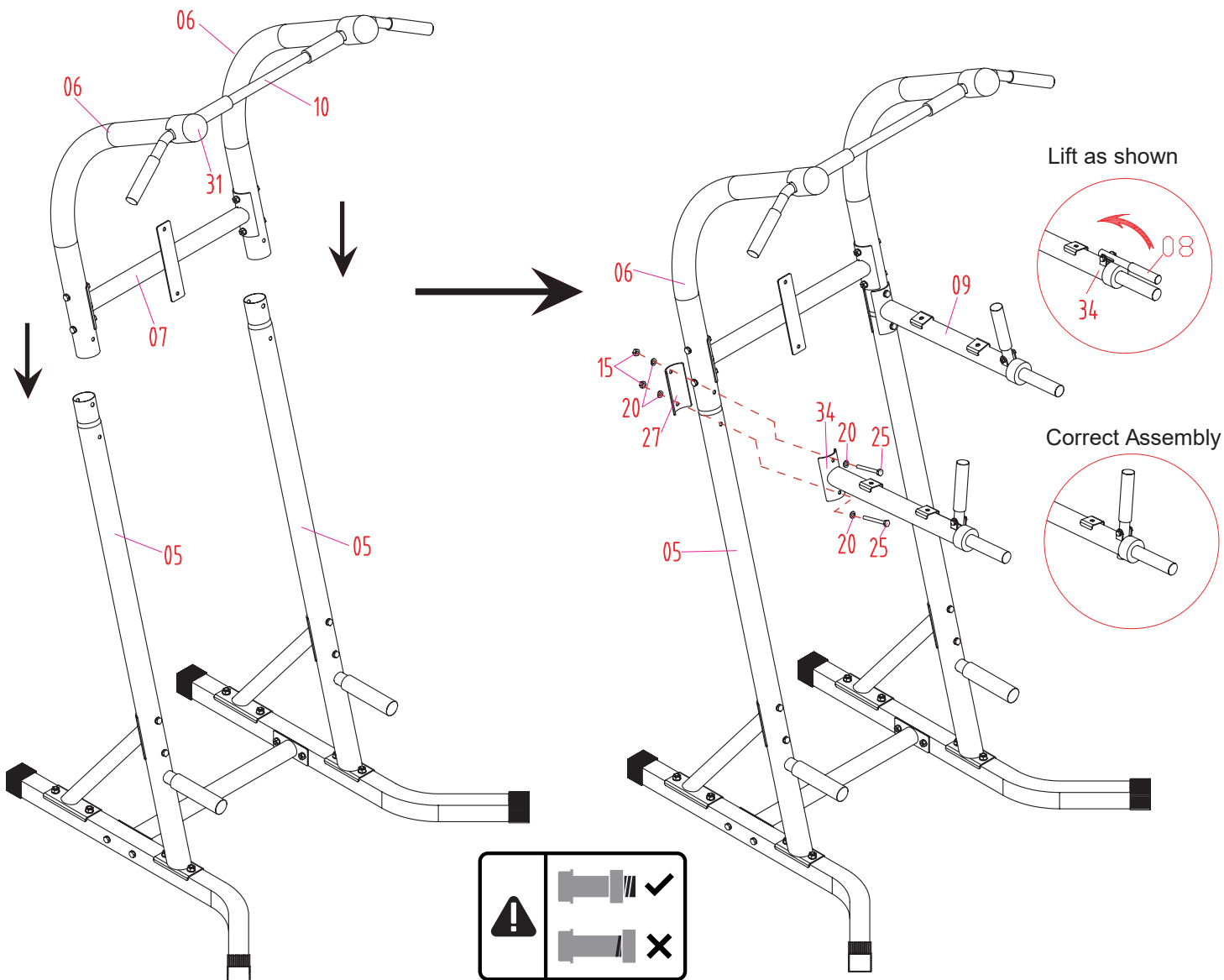

Assembly STEP 5

Secure the Back Pad (#11) to the Back Pad Support Frame (#07) using two Bolts (#30) and two Washers (#14).

DO NOT OVER TIGHTEN THE BOLTS (#30) AS THIS MAY STRIP THE THREAD OR CRACK THE WOOD IN THE BACK PAD (#11).

Secure the Arm Pad (#12) to the Arm Rest Support Frame -Right (#34) using two Bolts (#19) and two Curved Washers (#20) Repeat this process on the other side.

DO NOT OVER-TIGHTEN THE BOLTS (#19) AS THIS MAY STRIP THE THREAD OR CRACK THE WOOD IN THE ARM PAD (#12).

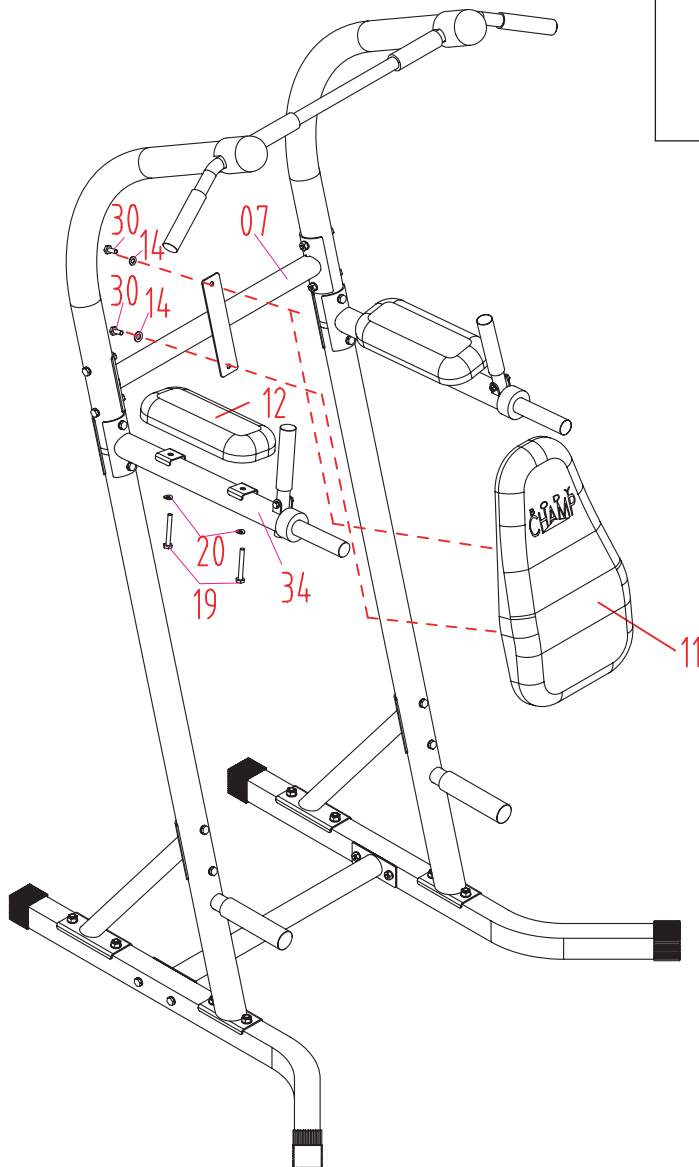

Hardware Required

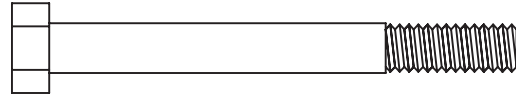

#19. Bolt (M8x70 mm) [4 pieces]

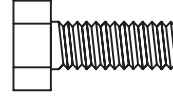

#30. Bolt (M8x20 mm) [2 pieces]

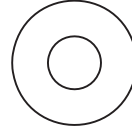

#14. Washer (M8)
[2 pieces]

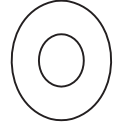

#20. Curved Washer (M8)
[4 pieces]



THE ASSEMBLY PROCESS IS NOW COMPLETE.

However, for your own safety, please make sure to read this entire Owner's Manual which includes safety instructions and warnings, as well as any safety/warning labels affixed to the product before use. For your safety, please visually and functionally inspect and test the unit after assembly is complete.

Part Listing

The following parts list describes all of the parts illustrated on the exploded diagram on the following page.

PLEASE NOTE: Not all of the parts and hardware you see here will be used while you are assembling the unit because some of these items are already pre-installed. Please use this page only as a reference guide for parts and hardware.

#	Description
01	Base Frame (Left)
02	Base Frame (Right)
03	Base Cross Frame
04	Upright Angle Support Frame
05	Upright
06	L Shaped Upper Frame
07	Back Pad Support Frame
08	VKR Handlebar
09	VKR Arm Rest Support Frame-Left
10	Pull Up Handlebar
11	Back Pad
12	Arm Pad
13	Bolt (M8x65 mm)
14	Washer (M8)
15	Lock Nut (M8)
16	Carriage Bolt (M10x65 mm)
17	Washer (M10)
18	Lock Nut (M10)
19	Bolt (M8x70 mm)
20	Curved Washer (M8)
21	Base End Cap
22	PVC Hand Grip (25 mm I.D.)
23	Foam Grip
24	PVC Hand Grip (32 mm I.D.)
25	Bolt (M8x75 mm)
26	Plastic Bushing
27	Curved Shaped Metal Plate
28	Screw (M8x35 mm)
29	Lock Nut (M6)
30	Bolt (M8x20 mm)
31	Upper Frame End Cap (55 mm)
32	Bolt (M6x40 mm)
33	Washer (M6)
34	VKR Arm Rest Support Frame-Right

Exploded View

The following diagram is provided to help you familiarize yourself with the parts and hardware that will be used during the assembly process.

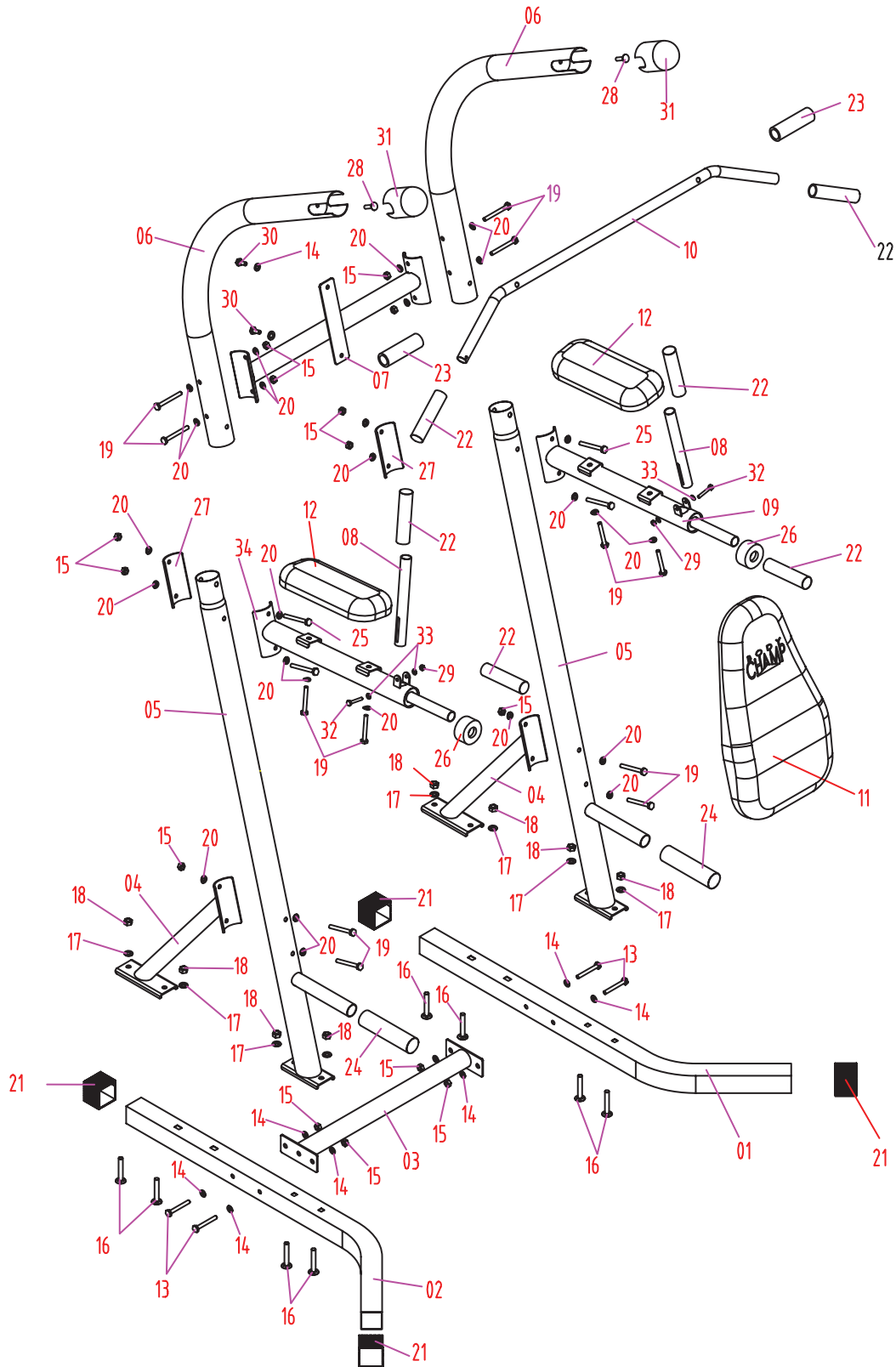

Safety and Maintenance

Safety & Warning

- Make sure all nuts, bolts, and screws are tightened prior to use.
- Be sure that all adjustment locking devices and safety devices are properly engaged prior to use!
- Never over-tighten the above-mentioned devices and parts to avoid damage to the unit.
- Check for loose parts and components and make proper adjustments prior to use.
- Check to see if there are any tears or bends in the welding or metal prior to use. If tears or bends are found, DO NOT use the unit and contact our CUSTOMER SUPPORT.
- Extreme care must be taken to not allow your feet, fingers, hair, clothing, and/or any loose items to be snagged into any portion of the unit when the unit is in use. Failure to follow these instructions could result in serious injury.

Maintenance & Care

- Please review all safety instructions and warnings in this entire Owner's Manual, as well as any safety/warning labels affixed to the product before use.
- To avoid rust or corrosion to the metal parts caused by moisture and sweat, we advise wiping and drying the unit with a dry absorbent towel after each workout session.
- Do not use solvent cleaners. If you are in any doubt, do not use your cleansing product; contact CUSTOMER SUPPORT.
- The specific Parts on your unit which may see possible signs of wear after prolonged use are listed as follows (please check these parts before each use): Back Pad (#11), Arm Pad (#12).
- For any replacement warning labels, please contact our CUSTOMER SUPPORT at :

1 (888) 266-6789 or **1 (909) 598-9876**, or mail in a written request to:

Hupa International, Inc.
21717 Ferrero Parkway
Walnut, CA 91789

More detailed information about how to reach our CUSTOMER SUPPORT may be found on the General Information page of this manual.

Warm-Up Instructions

Before use, you must read and understand all instructions & warnings stated in this Owner's Manual as well as posted on the equipment. Before beginning any exercise program including the following flexibility exercises, please consult with your physician.

The following flexibility exercises are provided to you as a means to prevent injury while you are exercising. A proper warm-up routine decreases the chance of injuring your muscles while you are exercising. Please take the time to do these flexibility exercises before and after each time you exercise.



Groin Stretch

1. Sit with your knees flexed and soles of feet together.
2. Hold your ankles and bend at your hips (keep your back straight) as you press your knees toward the floor with your elbows.

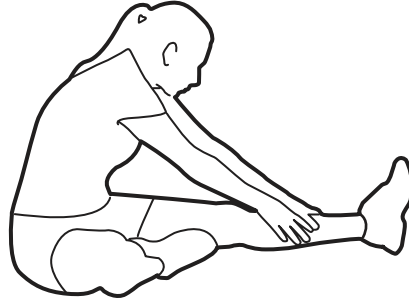

Hamstring Stretch

1. Sit with your left leg extended and bend your right leg at the knee as you place the sole of your right foot against the inner thigh of your extended leg.
2. Flex the foot of your extended leg (toes pointed toward ceiling) and gently bend forward from your hips; keep your back straight.
3. Reach your hands on your extended leg as far as possible and then switch legs and repeat.



Trunk Twister

1. Sit with your leg extended and bend your right knee as you cross your right leg over your left leg. Your right foot of your extended leg foot should be flat on the floor alongside your left knee.
2. Place your left arm on the outside of your right leg and pull against that leg while twisting your trunk as far as possible to the right. Place your right hand on the floor behind your buttocks. Reverse leg positions and repeat.

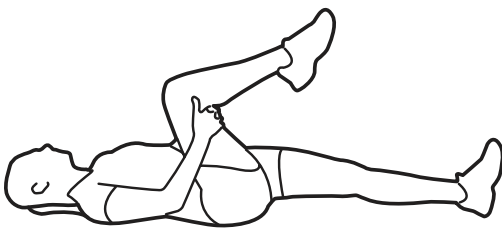

Groin Stretch

1. Lie on your back and raise your right leg as you clasp both hands under the back of the knee. Keep your left leg straight.
2. Gently pull your right leg toward your trunk without raising your upper body. Switch leg positions and repeat.

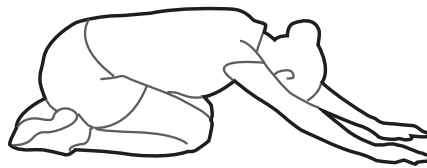

Trunk Flexion, Prone

1. Assume the depicted position on your hands and knees. Stretch your hands out in front of you and then slowly start to pull them back in toward your body as you tuck your chin and arch your back upward.
2. Return to the starting position slowly.

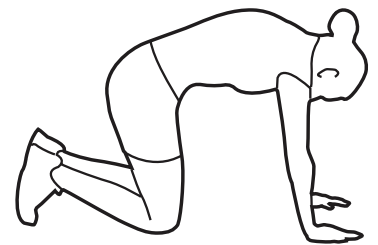

Warm-Up Instructions



Shoulder Stretch

1. Bring your right hand over your right shoulder to the upper back and bring your left hand under your left shoulder to the upper back.
2. Try to reach your fingertips. If you are not able to reach your fingertips, use a towel as an extension of your hands and gently pull one hand toward the other.
Reverse arm positions and

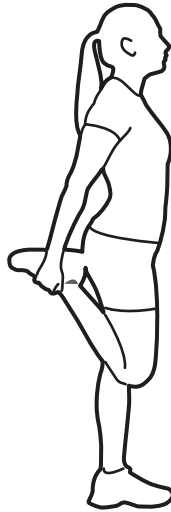

Quadriceps Stretch

1. Stand on your left leg and hold onto a support with your left hand.
2. Flex your right leg behind you, grasp your ankle or foot with your right hand and pull your foot toward your buttocks. Keep your back straight and right knee pointed down.
Repeat on the other leg.

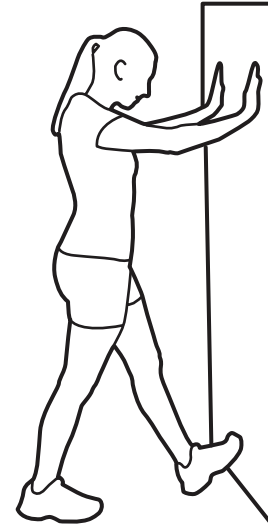

Calf Twister

1. Place both hands against a wall to aid your balance. Press the ball of your left foot against the wall and keep the heel of the same foot rested on the floor (make sure your left knee is bent).
2. Slowly start to straighten your left knee and you will feel the muscles in your left calf stretch.
Switch leg positions and repeat.

THANK YOU FOR YOUR PURCHASE
MODEL NO.: PT620 / VKR1808

Please fill in the information below and keep this manual along with your sales receipt as proof of purchase.

Serial Number :

Date of Purchase :

Retailer :

Hupa International, Inc.
21717 Ferrero Parkway
Walnut, CA 91789

Phone: 1 (888) 266-6789
Fax : 1 (909) 598-6707
Email : info@hupa.net