

OPERATOR MANUAL

Molift Mover 180



CE

Etac AS
Etac Supply Gjøvik
Hadelandveien 2
N - 2816 Gjøvik

molift[®]
by Etac

Innhold

About Molift Mover 180.....3
Declaration of conformity 3
Before using the lift 3

Pre-use checklist.....3

General safety information.....4
General 4

Safety instructions4

Assembly and dismantling4
Unpacking 4
Assembly..... 4
Dismantling 5
Storage and transportation..... 5

How to use the Molift Mover 1806

Lifting and moving7
Using the leg adjustment function 7
Using slings..... 8
Emergency stop and emergency lowering 8

Batteries and charging system9
Charging and handling the battery 9
Battery capacity..... 9
Electronics..... 9

Technical data 10
Labelling..... 11

Accessories 11
Lifting slings 11
Molift stretcher..... 11

Optional equipment..... 12
Alternative suspension with quick release12
Wheel with directional lock..... 12
Weight scale..... 12
Integrated charger..... 12

Troubleshooting 13

Maintenance 14
Cleaning 14
Monthly inspection 14
Servicing 14

Periodic inspection - Checklist 15

Explanation of symbols



This symbol appears in the operator manual alongside any information that applies to safety in the workplace or where there is a risk of person injury. Always follow these instructions carefully and exercise extreme caution.



This symbol indicates important and useful information. By observing this information, the operator will be able to work more efficient. This information may help simplify routines and explain complicated facts.

About Molift Mover 180

Molift Mover 180 is a mobile passive patient lifter. The battery powered lift is made from light materials, moves on wheels, has electrically adjustable legs and a safe working load of 180 kg. The Molift Mover 180 is suitable both in the home care and institutional environment.



Declaration of conformity

The Molift Mover 180 and related accessories described in this operator manual are CE marked in accordance with EU Council Directive 93/42/EEC concerning medical devices, class 1, and has been tested and approved by a third party according to standards IEC 60601-1, IEC 60601-1-2 and NS-EN ISO 10535:2006.

Before using the lift

Please refer to page 5 for information about how to assemble the lift.

You must complete the requisite training before using the lift on patients.

When using the lift, it is also important to only use accessories and slings that are adjusted to fit:

- the patient
- type of disability
- size
- weight
- type of movement

Pre-use checklist

1. Check the lift for any visible damage or defects.
2. Make sure that the lift's column and suspension are fastened properly and that the lift does not have any loose parts.
3. Make sure that the emergency stop switch is not activated and that the lift is working.
4. Make sure that the batteries are charged (i.e. the battery indicator on the hand control and battery holder is not illuminated).
5. Make sure that the service light is green. If it is yellow or red, the lift needs service.
6. If there are any faults or defects, the lift needs to be taken out of operation and marked "out of order". Contact the service personell or dealer.





General safety information

General

Before the Molift Mover 180 can be started up, operator must make sure that the lift is in good working order, in terms of both safety and operation.

The lift must be taken out of operation immediately if faults affecting safety and reliability are identified.

 *Molift Mover 180 has an SWL (Safe Working Load) of 180 kg. This means that it is built and tested to lift patients weighing up to 180 kg. When using accessories (e.g. slings and stretchers) with a lower SWL, the lowest SWL will apply.*

 *The lift may tip over if used incorrectly! Make sure you are familiar with the instructions before you attempt to lift anyone.*

The lift must not be used on sloping floors or ramps.

Use the push handle when manoeuvring the lift; do not pull the patient or the lifting arm.

 Electrical medical equipment is subject to special usage regulations in relation to electromagnetic compatibility (EMC) and needs to be installed and used in accordance with the instructions in this manual. Portable and mobile RF communication devices may have an effect on electrical medical equipment.

Safety instructions

- The lift has an overload protection function to prevent it from lifting more than 180 kg.
- The lift is also designed such that it cannot crush patients if it is lowered too far.
- Pressing the emergency stop button shuts off the power supply straight away and stops the lift.
- The lift features both an electrical and a manual emergency lowering function.
- The lift has a light to indicate when it needs service.

Assembly and dismantling

Unpacking

- The lift is delivered in a cardboard box. Make sure that the packaging is intact upon delivery. If it is not intact, check the contents of the box; if there is evidence of damage inside, contact your Molift representative straight away.
- The box contains a complete Mover lift unit, including hand control, battery and battery charger.

Assembly

- Roll the chassis out of the cardboard box.
 - Charge the battery.
- N.B. The battery must not be in the holder on the column during installation.
- Slide the column into the column holder on the chassis as shown in the pictures below.
 - Lock the lift column in place by fastening the two Allen screws in front and rear of the chassis as shown in the pictures below. This will ensure that the column cannot be pulled upwards.



Plug the hand control into the very bottom of the battery holder. The hand control has a hook so that it can be hung on the bracket at the top of the column.





- Insert the battery into the holder on the column with the two battery terminals facing downwards. Run the empty lift up and down a few times to make sure that it is working properly. (The batteries should always be charged prior to use.)
- Install the suspension as shown in pictures below. Align suspension in fork. Insert locking pin. Make sure locking pin is properly fastened.



Dismantling

- Remove the suspension.



- Run the lifting arm into its lowest position.
- Remove the hand control and battery from the lift to prevent it from falling out in transit.
- Remove both Allen screws on the front and rear, and remove the column.



Take care to ensure that your feet and arms do not get caught when the column and lifting arm are being lowered.

Storage and transportation

The lift is intended for use at room temperature, i.e. +10 to +40 °C. After transportation and storage, leave the lift to stand at room temperature so it can reach its normal operating temperature.

If the lift is being stored for a long time, we recommend that you remove the battery and activate the emergency stop.

The lift can be stored and transported under the following conditions:

Pressure: 50-106 kPa
Relative humidity: 20-90 %
Temperature: 0-45 °C

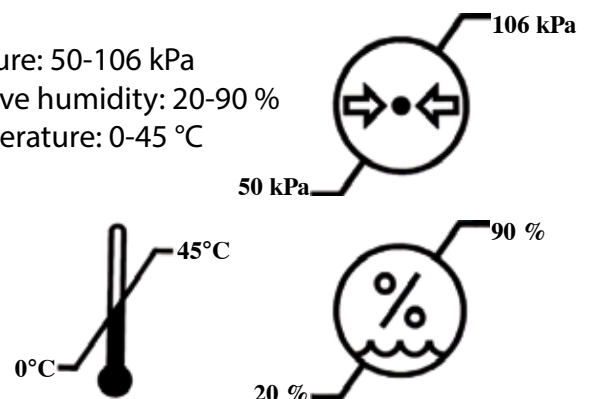

How to use the Molift Mover 180

Place the battery in the battery holder. The hand control for the Molift Mover 180 has four buttons to move the lift up and down and the legs in and out. The hand control has a LED that illuminates when the battery needs charging.

i *If the lift does not function when the relevant button is pressed, please refer to the troubleshooting guide in the Maintenance section to find out what is causing the problem.*

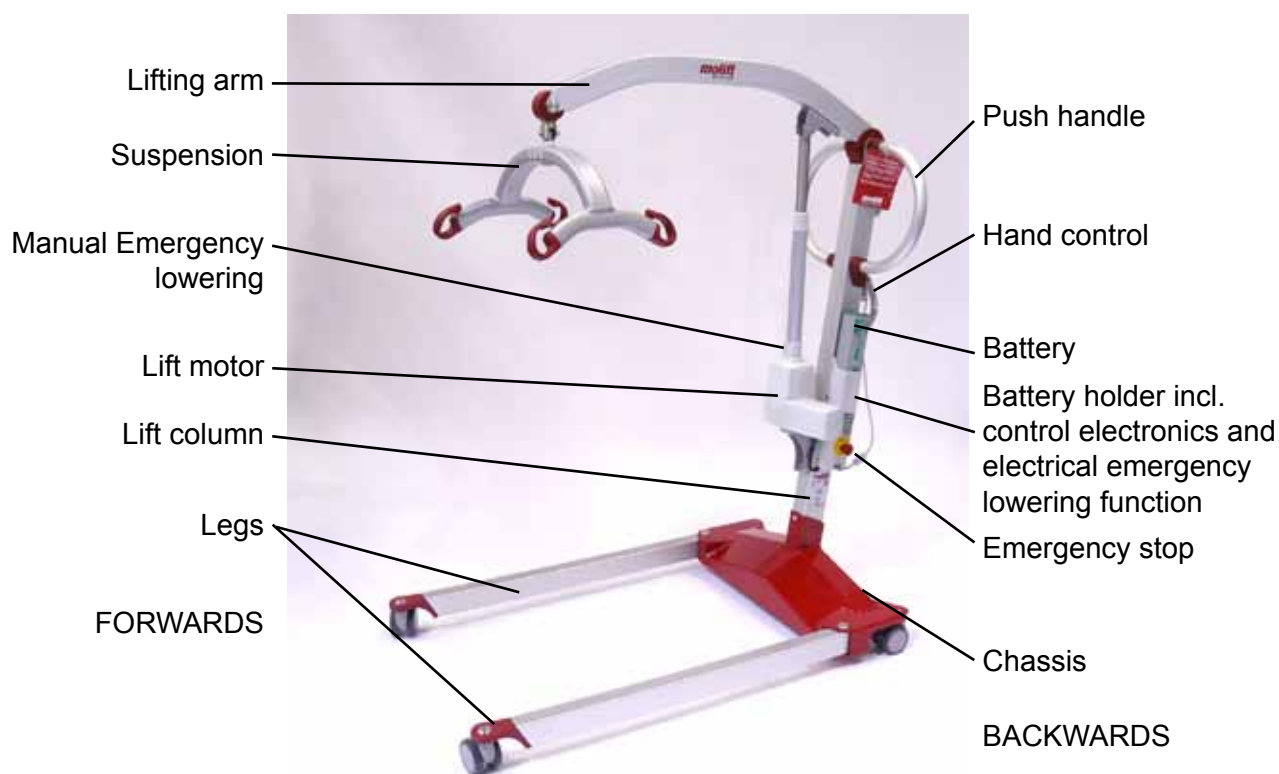
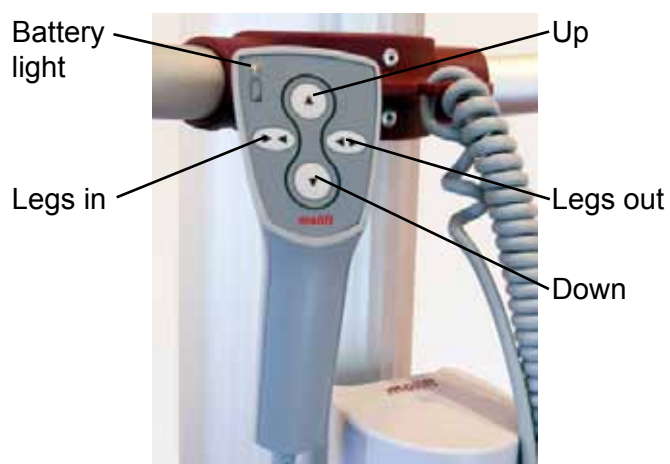

Lifting and moving

The suspension must always be placed crossways the person who is being lifted.

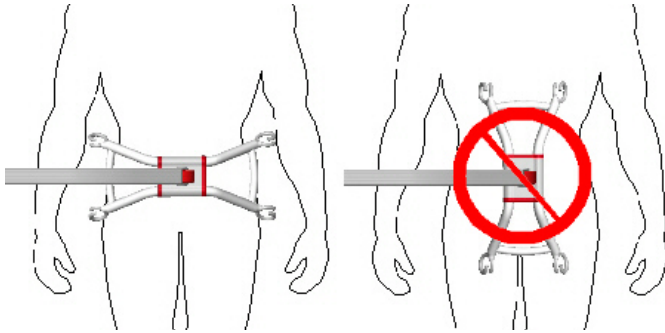

Make sure that the sling is fastened securely on all four hooks of the suspension so that the person in the sling does not slip or fall out.

When moving the patient, they must sit low-down, if possible with their feet placed on the base, or so that their centre of gravity is as low as possible. This will reduce the risk of instability and/or tipping over. The lift should also be moved with the legs as wide spread as possible to achieve maximum stability.

When moving the patient, stand to the side of the person you are lifting. Make sure that arms and legs do not obstruct the lift, seat, bed, etc. Keep eye contact with the patient to help them feel safe.

When moving the patient, take care to avoid collisions with objects and furniture in the room. Avoid thick carpets, high door sills, uneven surfaces and any other obstacles which may mean the wheels get jammed. If the lift is pushed over obstacles, it may become unstable and tip over.



The lift is designed to move patients over short distances only; it is not a replacement for wheelchairs or similar.

Using the leg adjustment function

Use a wide leg setting when necessary, e.g. to get round (wheel)chairs, toilets, etc.

The leg adjustment mechanism has a safety function to prevent the legs from hurting the patient when they are being lifted from the floor; the motor shuts down in the event of any unusually fast change to the leg setting. If this happens, press the opposite button to re-start the leg adjustment motor.

Using slings

Molift Easy sling is an all-round sling that fits most users and lifting situations in the home care and institutional environment. A variety of slings are available for each specific situation. Please consult the operation manual supplied with each sling for more detailed information on how to use and maintain them.

We recommend using Molift slings with Molift lifts. Slings made by other suppliers may vary in their specifications and centres of gravity, and could lead to instability and person injury.

Molift slings must only be used to lift people. NEVER use the slings to transport other objects.

 *Torn, cut, frayed or broken slings can fail, resulting in serious injury to the user. Use slings in good condition only. Destroy and discard old, unusable slings.*

Emergency stop and emergency lowering

 *Contact a service partner if the cause of the shutdown/emergency lowering is unknown, or if a fault is detected. The lift must be taken out of operation and marked with "out of order" until the issue has been resolved.*

Emergency stop

The emergency stop button can be found on the battery holder on the right-hand side of the column. The emergency stop shuts off the power. Turn clockwise to reset.

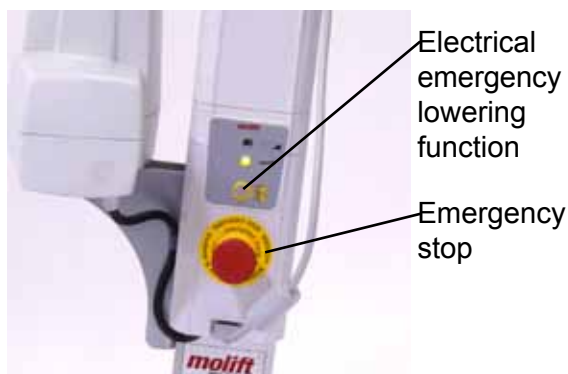

Electrical emergency lowering function

It is possible to perform an emergency lowering of the lifting arm in case of a general malfunction of the control electronics. The button can be found on the battery holder. If you need to perform an emergency lowering, move the lifter to a suitable location to lower the patient.

- Press the emergency lowering button on the battery holder; the lifting arm will then steadily move downwards. The electrical emergency lowering function does not work when the emergency stop is activated.
- If the lift still does not work, replace the battery and test the emergency lowering function again.
- If it fails to work, the patient will need to be lowered manually, either using the manual emergency lowering function or by calling for assistance.

Manual emergency lowering function

The lift has a manual emergency lowering function on its motor, which can be used when the electrical emergency lowering function is not working.

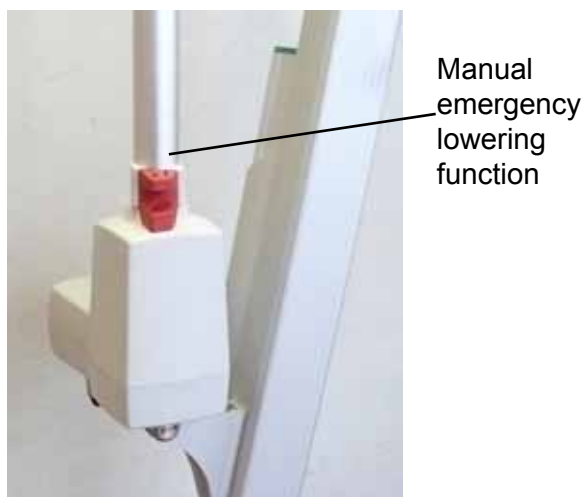

Pull the red handle up slightly. Exercise caution as the lift will move more quickly the higher the handle is pulled. Releasing the handle too quickly will increase the risk of person injury and damage to the lift.





Batteries and charging system

Charging and handling the battery

The battery charger can be used as a table-top unit or can be fixed to the wall. Connect to a wall socket when the battery needs charging.



Insert the battery into the charger. The light on the charger will come on.

LED	Mode
●	No bat
●	 ⌚
●	 ⌚
●/●	 ⌚
●	 👍
●/●	Error!

Battery capacity

The LED on the hand control and on the battery holder will illuminate when the battery power falls below a certain level, indicating that charging is needed. A sound signal will also be heard. If the battery goes flat in the middle of a lifting manoeuvre, there will always be sufficient power to lower the patient down again.

i New batteries will not work at full capacity until they have been fully charged and run empty several times.

Electronics

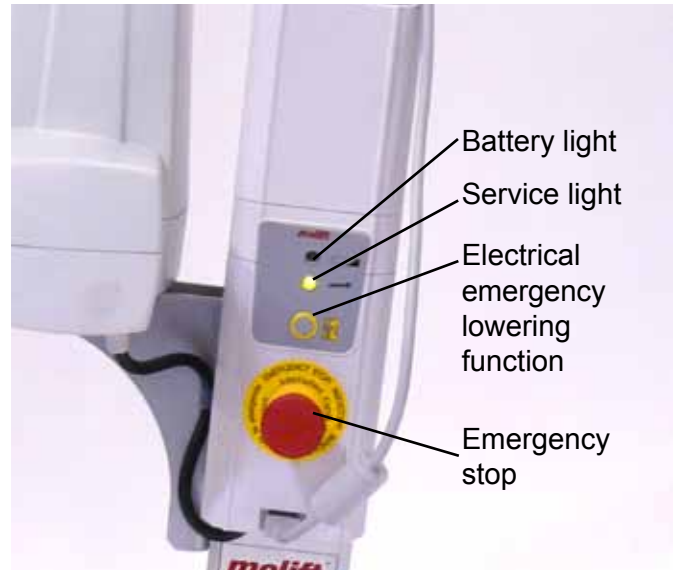

The lift counts the number of lifting manoeuvres performed. This information can be read using the Molift Service Tool, which will indicate when the lift needs a service, e.g. a new lift motor. Please also refer to the Maintenance chapter.

The electronics have an energy-saving function that shuts the system down after approx. ten minutes of inactivity. All the lights will go off. The electronics will be activated by pressing one of the operating buttons.

If the lift is in constant use for a long period of time, there is a risk of the electronics overheating and the lift stopping. Allow the lift to cool down sufficiently before using it again.

i Discarded lifters and batteries should be handled as electronic waste and collected separately according to local laws and regulations.

i Molift Mover 180 must not be in constant use for more than two minutes (in total) over the course of any one 18-minute period.

Technical data

Empty weight, total:

excl. battery and suspension: 32 kg / 70,5 lbs
 Chassis: 16 kg / 35 lbs
 Lift column: 16 kg / 35 lbs
 Battery: 0,85 kg / 1,9lbs
 Suspension: 0,9 kg / 2 lbs

Material:

Aluminium, steel and plastic composite

Motors:

Lift motor: 12 VDC
 Leg adjustment motor: 12 VDC

Battery:

14.4 V NiMH 2.2 Ah,
 20 A fuse (ATO Fuse)

Battery charger:

Mascot 2215,
 10-22 cells NiCd/NiMH

Casing:

IP24

Number of lifts with fully charged battery:

50 (75 kg, 50 cm / 165 lbs, 19,7 inches up/down)

Safe Working Load (SWL):

180 kg / 400lbs

Lifting range:

1360 mm / 53,5 inches

2 point suspension min/max lifting range:

370-1730mm / 14,5-68 inches

4 point suspension min/max lifting range:

270-1630mm / 10,6-64,2 inches

Lifting speed:

46 mm/sec / 1,06 inches/sec (With 75kg / 165 lbs)

Sound level, max A-weighted sound power level:

$L_{WA} = 49.4$ dB

Key force:

Buttons on handset: 3.4 N

Leg height:

Max. 115 mm / 4,52 inches

Turning circle:

1350 mm / 53,15 inches

Dimensions:

1250 x 695 x 1270 mm /

49,2 x 27,36 x 50 inches (LxWxH)

All dimensions in the illustration are shown in millimetres.



The lift has a 10-year service life, or 30,000 lifts under maximum load (SWL), if all recommended servicing is carried out.

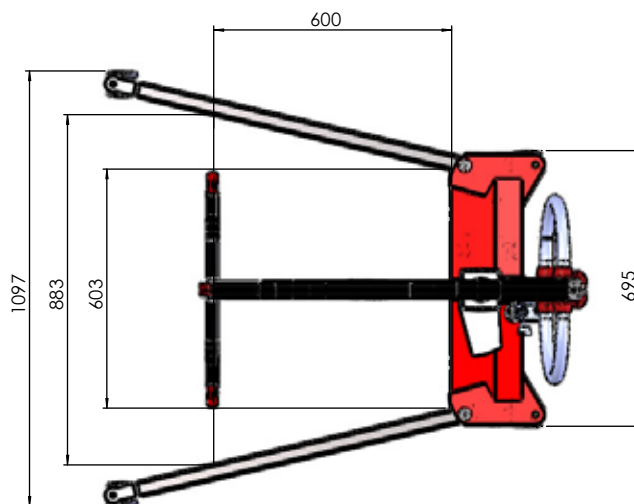
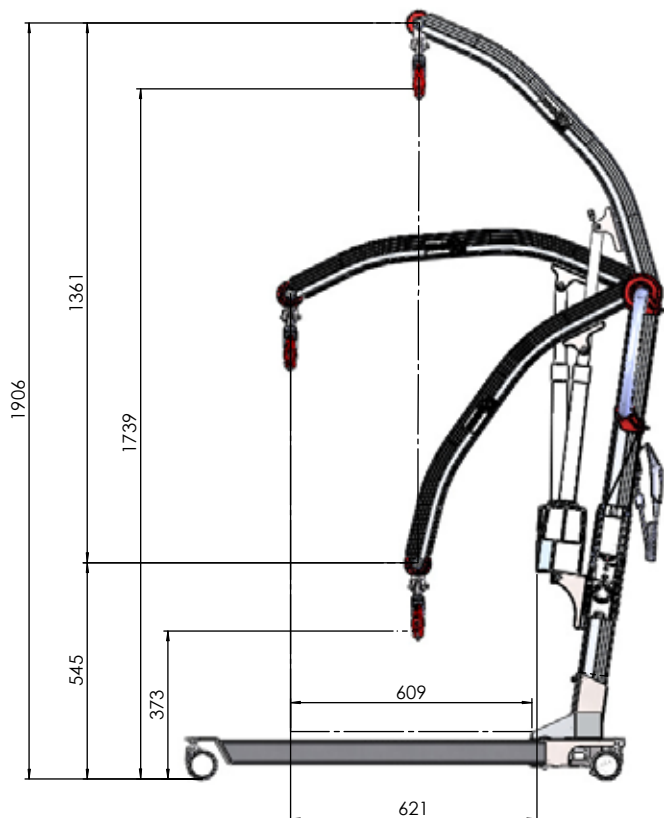

Labelling

The identification label can be found on the column.

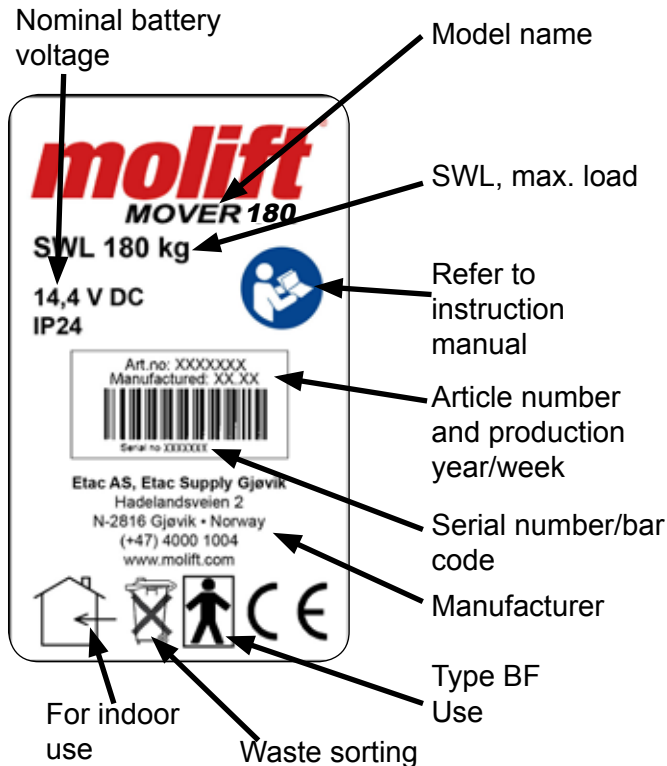

The periodic control label can be found on the column.

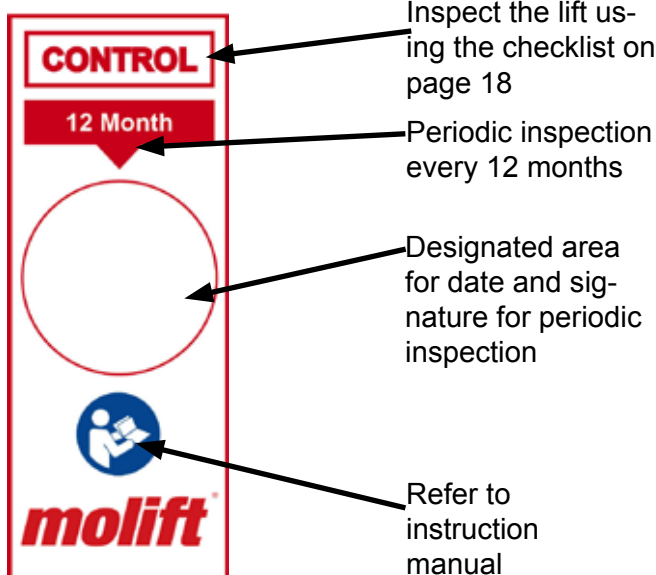

Accessories

Lifting slings

Molift supplies a wide selection of slings, and sizes for specific lifting situations. The slings are available in sizes XXS - XXL. Disposable slings are also available.

Molift stretcher

The Molift Stretcher is especially designed for lateral transfer of clients with suspected spinal injuries and fractures. It is approved and compatible with X-ray, CT-scan and MRI scanner. It attaches easily to the Molift 4-point suspension.

- Item no: 2150103 Molift Stretcher Standard excl. lifting loops and safety belts
- Item no: 2150108 Molift Stretcher with MRI-compatibility excl. lifting loops and safety belts
- Item no: 215037 Set of lifting loops (4pcs)
- Item no: 2150356 Set of straps with auto strap collectors (4pcs)
- Item no: 2150355 Set of safety belts (3 pcs)



Optional equipment

Alternative suspension with quick release

Aluminium suspension

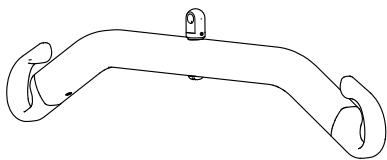

- 2-point, aluminium, large, 540 mm, Art. no.: 1830001

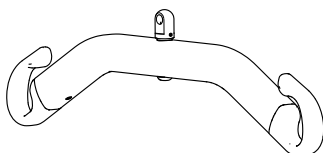

- 2-point, aluminium, medium, 440 mm, Art. no.: 1830002

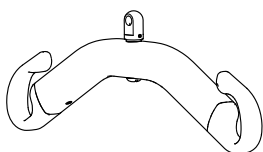

- 2-point, aluminium, small, 340 mm, Art. no.: 1830003

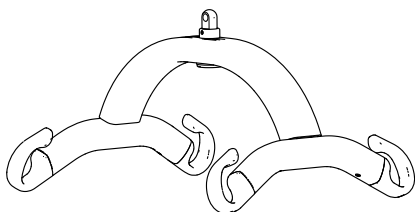

- 4-point, aluminium, 440 mm, Art. no.: 1830011

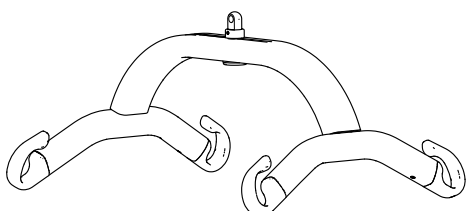

- 4-point, aluminium, 540 mm, Art. no.: 1830010

Wheel with directional lock

- Art. no. 1320140

The wheel must be installed by certified staff, who should follow the rear wheel change instructions in the technical manual.



Wheels with a directional lock have no brakes fitted; we therefore recommend changing only one of the rear wheels. Push down the red lever to lock the direction. To release, pull the lever up.

Weight scale

This scale is approved Class III. The scale can also calculate BMI (Body Mass Index) with a simple touch.

Art. no.: 1840000



-  Read the manual that comes with the weight scale prior to use.

The weight scale has a quick release and other suspension options, and can be replaced quickly by following the instructions on page 5.

Integrated charger

- Art. no. 1340005

This charger is attached to the lift as a permanent fixture. Park the lift and connect to a regular wall socket. The battery is charged in the battery holder.

Troubleshooting

If the lift is not working properly following assembly (page 4) and the pre-use checklist (page 3), the following troubleshooting table may help you to pinpoint the fault:

Symptom	Possible cause/solution
The lift column is unstable.	Check the lift column's holder and both allen screws as described in the assembly instructions on page 4.
The lift does not roll straight on level flooring.	<i>Clean the wheels</i>
	<i>Contact your local service representative.</i>
The lift only goes up or down/the legs only go in or out.	<i>Try a different hand control if you have one; you may need to replace the faulty hand control.</i>
	<i>Dismantle column to check contact point between chassis and column</i>
	<i>Contact your local service representative.</i>
The lift runs by itself/the leg adjustment works by itself .	<i>Clean the hand control contact with spirit to remove any grease.</i>
	<i>Replace the hand control/contact your local service representative.</i>
	<i>Contact your local service representative.</i>
The lifting arm does not move.	Make sure that the emergency stop is not activated (<i>turn clockwise to reset the emergency stop</i>)
	Conduct an inspection/ <i>change to a different battery or charge the battery</i>
	The lift's electronics have overheated; <i>allow the lift to cool down.</i>
	Make sure <i>that the load weighs no more than 180 kg.</i>
	Make sure that the hand control contact has not come loose.
	<i>Try a different hand control if you have one; you may need to replace the faulty hand control.</i>
	<i>Contact your local service representative; you may need to use the manual emergency lowering function to lower the patient.</i>
The battery does not charge.	There may be a fault with the battery; try a different battery or replace the battery.
	There may be a fault with the battery charger; try a different charger/ contact your local service representative.

If the troubleshooting does not help to resolve your current problem, please contact the relevant service personnel; your local representative or Etac AS may also be able to refer you to someone to help you with the problem.

Maintenance

Maintaining the lift involves pre-use checklist, cleaning, inspections and servicing. Inspect the lift using the pre-use checklist before using the lift to locate any faults or problems. You should also carry out routine inspections of the lift, namely a monthly inspection and a periodic/yearly inspection.

Cleaning

i Use pH-neutral cleaning agents. If disinfection is required, use isopropyl alcohol. Do not use abrasive or corrosive substances for cleaning.

- Cleaning shall be done on a regular basis. Clean the outside of the lift using a slightly damp cloth and a suitable cleaning agent.
- Remove any hair and fluff from the wheels and make sure the wheels move freely.
- You may need to carefully clean the hand control contact and cord with spirit to remove any grease.

Monthly inspection

The lift must be set up for use during the inspection.

- Inspect the lift using the pre-use checklist of things to do before using the lift (page 3).
- Clean the lift.
- Make sure that the hand control contacts and charger are securely in place and that the cables on the hand control and charger are intact.
- Run the lift up and down to make sure that it is working correctly and not making unusual noises.
- In the event of any faults or problems, take the lift out of operation, mark it with "out of order". Contact service personnel.

Periodic inspection

Molift recommends a periodic inspection of the lift once a year. Current guidelines in this area may need to be taken into consideration. This periodic inspection is carried out using the checklist on page 15.

The inspection should be conducted by authorised personnel. The owner is responsible for making

sure that the checklist is completed and signed each time the lift is inspected.

Servicing

A service light indicates when the lift needs servicing. The light illuminates green to indicate that the lift can be used as normal.

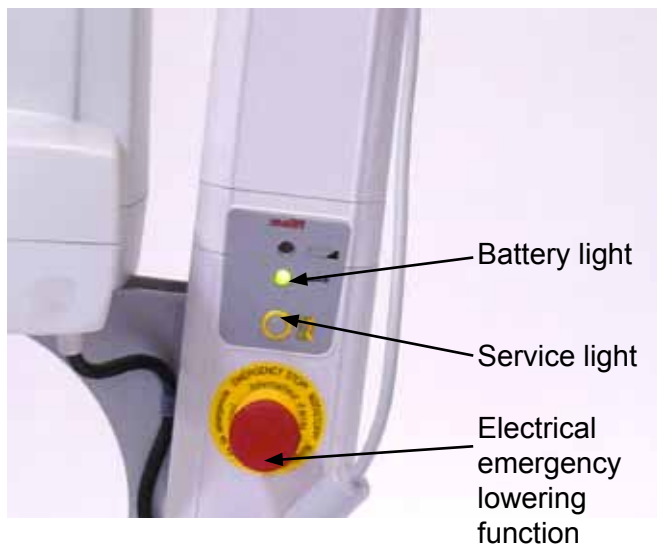

The electronics record the loads lifted and how much the lift has been used. After a certain period of operation a signal is given to indicate that service is required. The service light has the following signals:

Service light	Status
Not illuminated	Power-save mode
Green	Ready for use
Yellow	Book service, lift still functional
Red	Service required
Red + sound signal	Service urgently required

Service involves replacing the lift motor and inspection/replacement of worn parts. This must be carried out by authorised personnel as described in the technical manual instructions.

Authorised service personnel can use the Molift Service Tool to take readings of the lift's data and to log servicing work. The owner of the lift is responsible for logging servicing work and repairs.

Periodic inspection - Checklist

Location and date:

Lift model and serial number:

Client:

Name and certification number of inspector:

Tick if OK. if any of the items are not OK, take the lift out of operation and send it for repair.

- The entire lift has been checked for damage, cracks and deformation, and is considered to be in good working order.
- The lift has been assembled correctly and no parts are missing.
- The accessories have been checked. (There is a separate list for slings. The battery charger is an accessory.)
List of inspected accessories:.....
- The emergency stop function and hand control have been checked and are working.
- The lift rolls across the floor (preferably checked with a load) and its movement is smooth and steady.
- The leg adjustment mechanism has been extended fully and then retracted fully (preferably checked with a load); its movement is smooth and makes no noise (stops in the correct position).
- The lift has been moved to the top and to the bottom (preferably checked with a load); its movement is smooth and makes no noise.
- Service is not required if the service light is green and the lift is under 5 years old.

If the lift needs servicing or repairs, it should be taken out of operation.

- The lift passed the safety inspection. It has been stamped with the Molift safety inspection mark, which is signed and dated.
- Has a completed and signed checklist been forwarded to the client, and a copy sent to your Molift representative?

Notes:

Signature: