



**PROTEKT[®] DASH
STANDING TRANSFER
MODEL: 32500**



OWNER'S MANUAL

**270 Washington Street
Mount Vernon, NY 10553
855-237-7622
www.proactivemedical.com**

Thank you for choosing the Protekt[®] Dash Standing Transfer!

To better serve you, please record the following information:

Supplier Name : _____

Telephone : _____

Serial # : _____

Date of Purchase : _____

INSPECT YOUR MERCHANDISE

Upon receipt of your patient lift, verify that all merchandise is complete and free from any shipping damage. Refuse delivery if the packaging appears to be badly damaged. If the merchandise is received damaged or is missing components, contact the shipping company immediately and file a claim.

For further assistance, contact your local dealer or Proactive Medical at the following:

Proactive Medical Products
270 Washington Street
Mount Vernon, NY 10553
Tel: 855-237-7622
www.proactivemedical.com

 **WARNING: Do not operate the Protekt® Dash Standing Transfer 32500 without first reading and understanding this manual. If you do not understand the warnings, cautions, and instructions provided herein, contact your professional medical advisors, authorized distributor, or technical representative before proceeding with the use of this product; otherwise personal injury or damage to your Standing Transfer could result.**

REPLACEMENT PARTS

LP-32500-FC	Replacement Front Caster f/ Protekt 32500 Lift
LP-32500-HPK	Replacement Hardware Pack f/ Protekt 32500 Lift
LP-32500-KP	Replacement Knee Pad f/ Protekt 32500 Lift
LP-32500-RC	Replacement Rear Caster f/ Protekt 32500 Lift
LP-32500-SC	Replacement Seat Cushion f/ Protekt 32500 Lift

1. INTRODUCTION

Important safety, operating, and maintenance instructions that warrant your attention are included in this manual. Read the entire manual carefully before operating your new Protekt® Dash Standing Transfer 32500, keep it handy for future reference, and refer to it as often as necessary to help maintain good performance standards.

The Protekt® Dash Standing Transfer is a manual standing aid that requires patients to assist themselves in preparation for transport. Patients qualified to use the Standing Transfer must have adequate arm strength to pull themselves upward and enough leg strength to support their own weight. Patients who meet these criteria and have difficulty walking will find the Standing Transfer a useful transport device. Functionally, the Standing Transfer is positioned between a traditional walker and a battery powered sit-to-stand lift. The Standing Transfer is a convenient toileting alternative to a wheelchair. Once the resident has positioned themselves on board, the split seat can be positioned to allow the resident to sit comfortably while a caregiver performs the transport. For residents lacking the strength to assist themselves, we recommend a battery powered sit-to-stand lift.

The Protekt® Dash is capable of the following transfers when used according to the instructions:

- Bed to chair/wheelchair
- Bed/chair/wheelchair to commode
- Room to room

The safety precautions in this manual are general warnings intended to be used only as basic guidelines. You may find it necessary to develop your own methods for safely solving frequently encountered challenges. Again, consult your professional medical advisors for their recommendations about safety methods, and never hesitate to ask for their assistance.

INTENDED USE

The Standing Transfer's intended use is as a transport assistance unit.

Contraindication

The Protekt® Dash Standing Transfer is intended for use by residents who have the strength and stability to lift and support themselves. We recommend a battery powered sit-to-stand lift for residents with limited strength and stability.



WARNING: Personal Injury - This device is designed for transport assistance of individuals between approximately 5'1" and 6'6" (155 cm and 198 cm) in height. Verify this information on the individual being transferred before use.

2. SAFETY PRECAUTIONS

- ⚠ WARNING:** Always follow these safety precautions when using your **Protekt® Dash Standing Transfer**. Failure to do so could result in personal injury to you or others or damage to the **Standing Transfer**.

Safety requires the constant attention of the **Standing Transfer** user and attendant. It is extremely important to learn and always use safe methods of performing basic daily activities. Always consult your professional medical advisors to determine those methods most suitable for your individual abilities.

SIGNIFICANCE OF SAFETY STATEMENTS

Please note the following special statements used throughout this manual, and their significance:

- ⚠ WARNING:** Indicates a potential hazardous situation or unsafe practice that, if not avoided, could result in death or serious personal injury.
- ⚠ CAUTION:** Indicates a potential hazardous situation or unsafe practice that, if not avoided, could result in minor or moderate personal injury.
- ⚠ NOTICE:** Indicates a potential hazardous situation or unsafe practice, if not avoided, could result in product or property damage.

WARNINGS!

- ⚠ WARNING:** Only qualified caregivers trained in the **Standing Transfer** should use it to transport patients.
- ⚠ WARNING:** Do not use the **Standing Transfer** to transport patients who are unable to pull themselves upright and support their own weight.
- ⚠ WARNING:** The **Protekt® Dash Standing Transfer's** maximum weight capacity is 500 lbs. (230 kg), **EVENLY DISTRIBUTED**. Never use the **Standing Transfer** to transport a patient whose weight exceeds 500 lbs. (230 kg).
- ⚠ WARNING:** Before using the **Standing Transfer** for patient transport, check the **Standing Transfer** to ensure all components are properly and securely assembled and in working order.
- ⚠ WARNING:** Do not leave a patient unattended during any part of the transport.
- ⚠ WARNING:** If components are damaged or missing, contact your **Proactive Medical** authorized distributor immediately. **DO NOT** use substitute parts. Use only **Proactive Medical** replacement parts. The use of non-**Proactive** replacement parts could cause personal injury, property damage, and void the warranty.

3. HANDLING PROCEDURES

SHIPPING AND TRANSPORTATION INSTRUCTIONS

If the Standing Transfer is to be reshipped by common carrier, it should be packed in the same carton in which it was received.

Unpacking

 **WARNING: The lift is heavy! To avoid personal injury, DO NOT attempt to remove the lift from the box without assistance.**

1. Check for any obvious damage to the carton or its contents. If damage is evident, notify the carrier or your Proactive Medical Products authorized distributor.
2. Remove all loose packing from the carton.
3. Carefully remove all the components from the carton.

Info: Unless the Standing Transfer is to be used immediately, retain boxes, containers and packing material for use in storing until use of Standing Transfer is required.

Inspection

1. Examine the exterior of the Standing Transfer for nicks, dents, scratches or other damage.
2. Inspect all components.

Storage







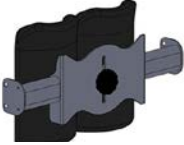

1. Store the repackaged Standing Transfer in a dry area.
2. DO NOT place other objects on top of the repackaged Standing Transfer.

4. FEATURES

COMPONENTS

Item	Description	Quantity
	Base preassembled with footplate and casters	1
	Side support arm unit	2
	Kneepad assembly	1
	Seat pad and handle bar support unit with cross bar tube	2

FASTENERS AND TOOLS

No.	Photo	Description	Quantity
A1		Carriage bolt	8
A2		Button socket head cap screw	4
A3		Flat washer	9
A4		Lock washer	9
A5		Acorn nut	8
A6		Knobs	1
T1		Wrench	1
T2		Hex key	1

5. ASSEMBLY INSTRUCTIONS

Tools required: provided wrench, provided hex key

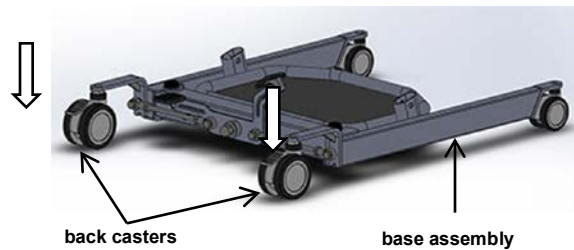

1. Place the base assembly on the floor and lock the back casters for ease of assembly, as shown above.

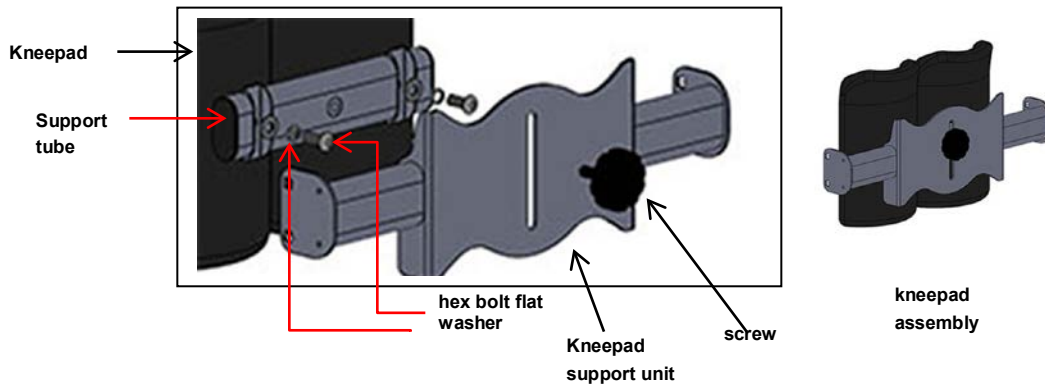

2. Install the two hex bolts through washers to support tube, and then fit it on kneepad support unit by screw as shown above. Tighten securely with the provided wrench. The finished assembly is shown at right above.

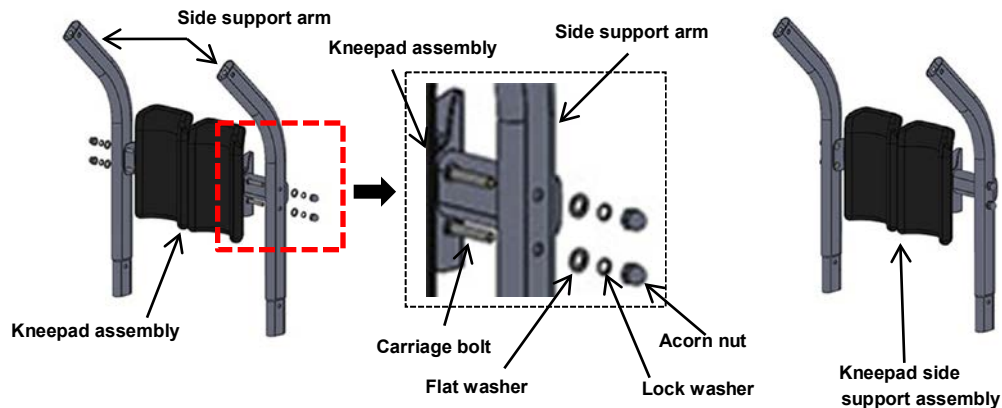

3. Attach the kneepad assembly to the two side support arms. Face the square holes on the side support arms inward; fit the square shoulder of each carriage bolt in the square hole, installing each carriage bolt through the kneepad assembly bracket and side support arm from the inside as shown above. Install the flat washer, lock washer, and acorn nut on the end of each carriage bolt as shown above. Do not tighten the nuts; some play in this assembly will be needed to assemble the entire unit. The finished assembly is shown at right above.

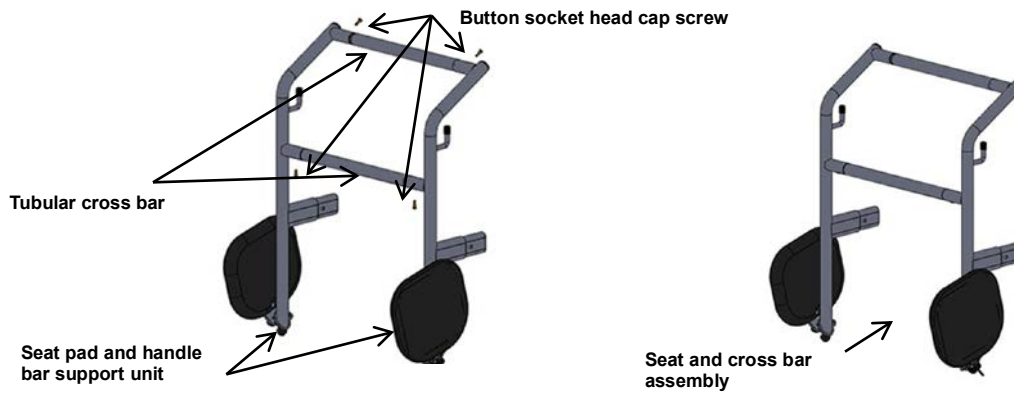

4. Insert the two tubular cross bars into the holes on the seat pad and handle bar support units as shown above. Align the small holes on the cross bar undersides with the holes in the support units. Install the four button socket head cap screws through the support units into the cross bars. Use the hex key to tighten. The finished assembly is shown at right above.

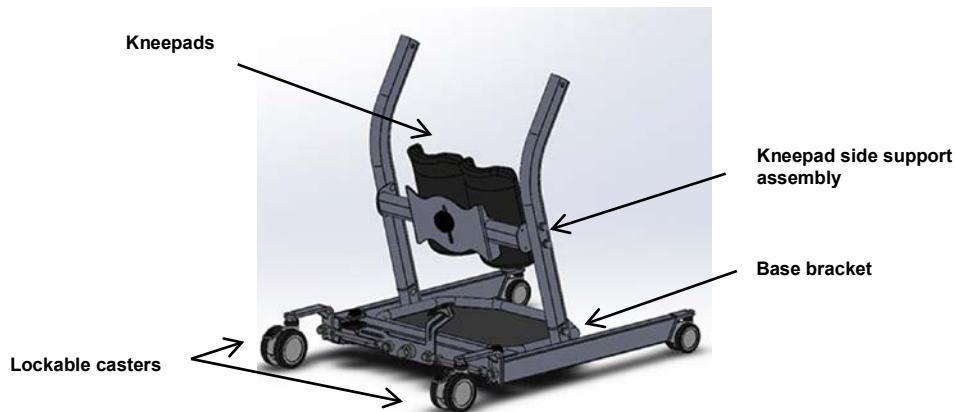

5. Insert the kneepad side support assembly into the base brackets as shown above. The kneepads and arm curvature should be facing away from the lockable casters.



6. Insert the seat and cross bar assembly into the tubes at the top of the kneepad side support assembly as shown above.

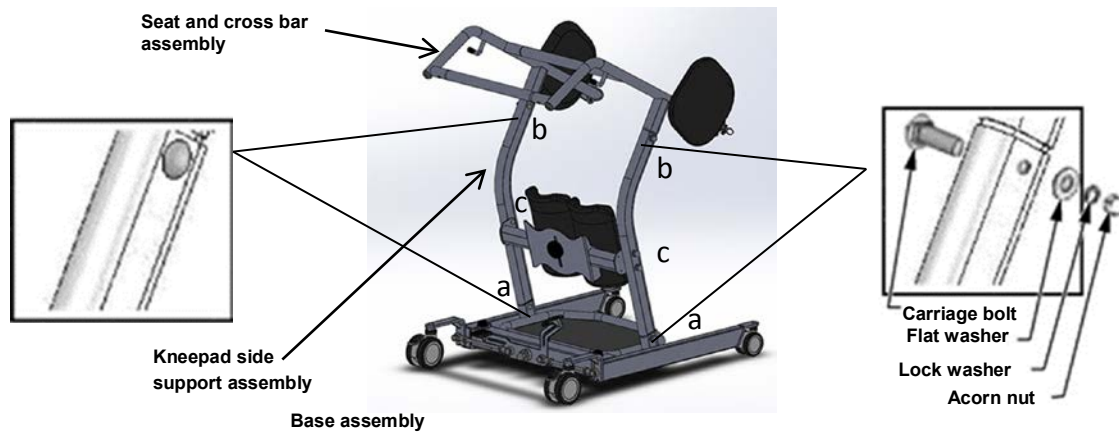

7. Fasten the seat and cross bar assembly, kneepad side support assembly, and base assembly together with carriage bolts:
 - a. Attach the kneepad side support assembly to the base assembly. Fit the square shoulder of each carriage bolt in the square hole at inside of base bracket, installing each carriage bolt through the base and kneepad side support assembly as shown above. Install the flat washer, lock washer, and acorn nut on the end of each carriage bolt as shown above. Tighten the two nuts securely using the provided wrench.
 - b. Attach the seat and cross bar assembly to the kneepad side support assembly. Fit the square shoulder of each carriage bolt in the square hole at inside of kneepad side support assembly, installing each carriage bolt through the kneepad side support assembly and seat and cross bar assembly as shown above. Install the flat washer, lock washer, and acorn nut on the end of each carriage bolt as shown above. Tighten the two nuts securely using the provided wrench.
 - c. Securely tighten the four nuts that attach the kneepad assembly to the two side support arms, installed in step 3, using the provided wrench.

⚠ WARNING: Before operating the Standing Transfer, ensure that all components are properly and securely assembled and that all fasteners are secure.

⚠ WARNING: Before operating the Standing Transfer, read the operation instructions.

6. OPERATION

The split seat units can be rotated upward to allow for patient loading. Then, once the patient is in an upward standing position, lower to form a complete two-sided seat.

 **WARNING:** Ensure that both seat units are fully lowered and form a complete seat before having the patient sit down on the Standing Transfer.

 **WARNING:** Do not leave a patient unattended during any part of the transport.

1. Raise the two split seat units so that they are parallel to the side of the Standing Transfer, as shown at right.



2. Step on foot pedal to open to base, so the Standing Transfer can be moved into patient closely.



3. Have the patient positioned at the edge of the surface to be transferred from. Move the Standing Transfer in front of the patient. Position the patient so that feet are firmly on the platform and knees and shins are in contact with the two cupped kneepads, as shown at right.



4. Lock the casters by stepping on the caster clip and pushing down, as shown at right.



5. Have the patient grasp the cross bar closest to them and using their own strength, pull up into a standing position securely on the base platform, as shown at right



6. Lower both of the split seat units down into position to form a complete seat, as shown at right.

 **WARNING:** Ensure that both seat units are lowered and form a complete seat before having the patient sit down on the Standing Transfer.



7. Have the patient lower themselves down onto the seat while keeping knees and shins in the kneepads, while continuing to hold the cross bar with both hands, as shown at right.



8. Unlock the casters. Place both hands on the cross bar furthest from the patient, step on another side of foot pedal to close the base as shown at right, and move the Standing Transfer to the new surface. Ensure that the patient is secure and in proper position as described in Step 7 before and during transfer, as shown at right.



9. Position the Standing Transfer against the new surface, step on foot pedal to open the base ensuring that the patient will be in a position to sit down firmly and safely on the transfer surface.

Have the patient pull themselves back up to a full standing position. Raise the two split seat units so that they are parallel to the side of the Standing Transfer, as shown at right, to allow the patient to lower themselves.

Stand beside the patient as they lower themselves down onto the new surface.

Ensure that the patient is safely positioned. Unlock the casters, step on another side of foot pedal to close the base and move the Standing Transfer to storage.



7. MAINTENANCE

To ensure safety and proper use, perform the following steps monthly:

- Check all fasteners to ensure that they are securely fastened and no wear and tear is evident. Replace and tighten any worn fasteners before using the Standing Transfer.
- Check the two seat assemblies to make sure that the bolts are tight. Replace any worn or damaged seat components before using the Standing Transfer.
- Check the casters to make sure they are securely positioned in the Standing Transfer. Replace any worn or damaged casters before using the Standing Transfer.

If any maintenance procedure is not clear, ask your Proactive Medical Products authorized distributor for assistance.

NOTICE: Improper maintenance can cause operating problems and may affect your warranty.

⚠ WARNING: Unauthorized modification or the use of unauthorized replacement parts could change the structure of the Standing Transfer, void the warranty, and create a hazardous condition resulting in serious personal injury.

CLEANING THE STANDING TRANSFER

- Wipe off the frame at least once a week with a soft cloth. Dry the Standing Transfer immediately if exposed to moisture.
- Clean the frame every three months. Frame does not need to be waxed.
- Clean upholstery and plastic components at least once a month with a mild soap and water solution.

NOTICE: Do not use solvents, abrasive waxes, caustic chemicals or spray silicone to clean the Standing Transfer.

NOTICE: Do not use abrasive cleansers to clean the Standing Transfer; they could scratch the finish.

NOTICE: Do not use steam or high pressure cleaners to clean the Standing Transfer.

8. LIMITED WARRANTY

The Propekt® Dash you purchased is guaranteed to be free from defects in material and workmanship under normal use and service. The warranty period for this product is 3 Years on Frame from the date of purchase by the original purchaser. This warranty shall be voided upon transfer of ownership of this product. Proactive Medical agrees to repair or replace this product, at our discretion and at no charge, within the warranty period provided and that Proactive Medical consents the unit is defective. The repaired or replacement unit shall be warranted for a period equal to the balance of the defective unit's warranty period.

NOTE:

To ensure the best service to our customers, Proactive Medical requires the following information to be included with the returned unit:

1. Model Name/Number and Serial Number on the packaging.
2. Proof of purchase, i.e. a copy of the original invoice.
3. A Return Authorization number (RA#) obtained by calling Authorized dealer/distributor prior to the return of the product. The RA# must be clearly indicated on the outside of the packaging.
4. A detailed description of the problem and its symptoms on a note.

This warranty shall not apply to any product which has been repaired or altered in any way so as, in our judgment, to affect its functionality and durability, nor to any product subject to abuse, misuse, negligence or accident, improper maintenance, improper installation, nor to any product used with other parts, components and/or accessories with quality and/or specifications not compatible with this product. This warranty does not cover products that have been impaired by occurrences considered Acts of God over which authorized dealer has no control. This warranty shall also be voided if any required periodic maintenance, if applicable, has not been properly performed on this product.

This warranty and the aforementioned remedies presented are exclusive and in lieu of all other express or implied warranties. No other representations or claims shall be binding or obligate authorized dealer in any way. Any warranty applicable to this product is limited to the aforementioned period indicated. In no event shall authorized dealer be liable for any special, incidental, or consequential damages; loss of revenue; or cost of replacement goods; resulting from the use or malfunction of this product to the associated equipment on which and with which it is used. This warranty gives specific legal rights and you may be entitled to other rights that vary from state to state.