



**PROTEKT® 600 LIFT**  
**POWER PATIENT LIFT**  
**MODEL: 33600**



**OWNER'S MANUAL**

**270 Washington Street**  
**Mount Vernon, NY 10553**  
**855-237-7622**  
**[www.proactivemedical.com](http://www.proactivemedical.com)**

## **Thank you for choosing the Protekt® 600 Lift!**

To better serve you, please record the following information:

Supplier Name: \_\_\_\_\_

Telephone: \_\_\_\_\_

Serial #: \_\_\_\_\_

Date of Purchase : \_\_\_\_\_

### **INSPECT YOUR MERCHANDISE**

Upon receipt of your patient lift, verify that all merchandise is complete and free from any shipping damage. Refuse delivery if the packaging appears to be badly damaged. If the merchandise is received damaged or is missing components, contact the shipping company immediately and file a claim.

For further assistance, contact your local dealer or Proactive Medical Products at the following:

Proactive Medical Products  
270 Washington Street  
Mount Vernon, NY 10553  
Tel: 855-237-7622  
[www.proactivemedical.com](http://www.proactivemedical.com)

# Features Chart:



- 1. Boom
- 2. Spreader Bar
- 3. Mast
- 4. Actuator
- 5. Base
- 6. Pendant
- 7. Control Box
- 8. Caster with Brake
- 9. Front Caster
- 10. Emergency Lowering Device

# Diagram of Control Box:

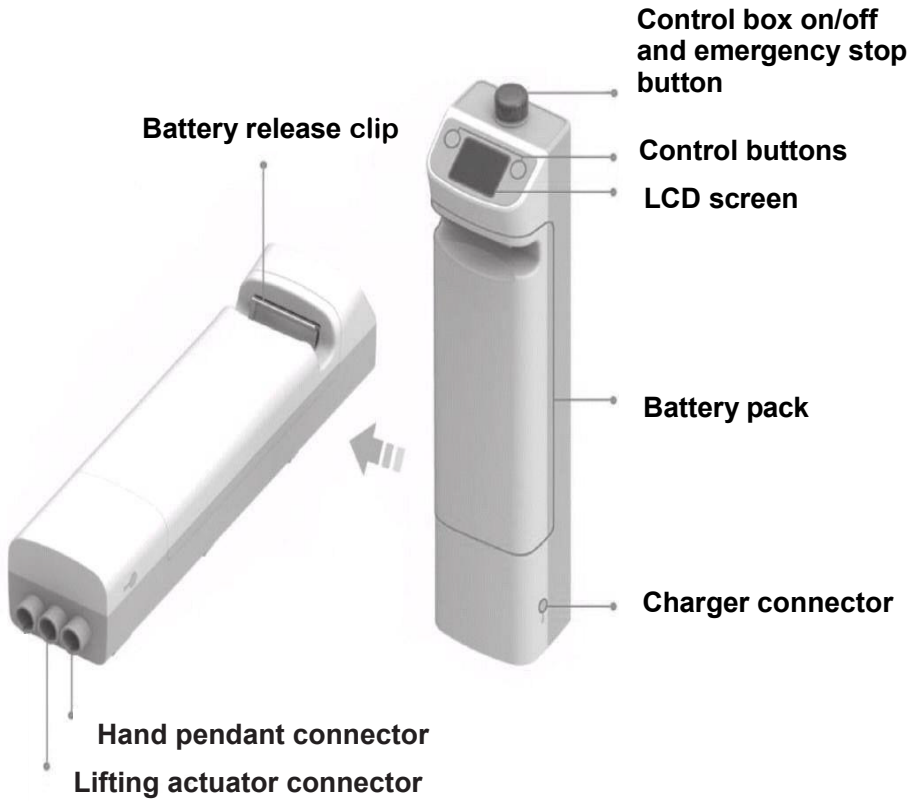

## **SAFETY INSTRUCTIONS**

The Protekt® 600 Power Patient Lift 33600 reflects innovative state of the art design to increase user mobility.

The Protekt® 600 Lift will provide years of service if it is properly maintained as any piece of electrical/mechanical equipment requires.

Please pay careful attention to the following important information regarding the care, maintenance, and operation of the Protekt® 600 Lift. Carefully read these instructions before assembling the lifter, or attempting to lift any user with the device.

**PLEASE NOTE THE FOLLOWING:**

- Special care must be taken with users/patients who cannot themselves provide assistance while being lifted. (i.e. patients who are comatose, spastic, agitated, or otherwise severely handicapped.)
- The Protekt® 600 Lift should be used solely for transferring a user/patient from one utility (beds, bathtubs, toilets, etc.) to another. The patient lift should not be used for transporting or moving any patient from one location to another location.
- During lifting or lowering, whenever possible, always keep the base of the lift in the widest position.
- The base of the lift should be closed before moving the lift.
- Do not roll casters over any object while the user/patient is in the sling.
- While being lifted in a sling, always keep the user/patient centered over the base and facing the caregiver operating the lifter.
- Maximum weight that can be safely lifted is 600 lbs.

The Protekt® 600 Lift allows a person to be lifted and transferred safely with minimum physical effort provided by the caregiver. Before attempting, practice operating the lift. Also prior to actual lifting, explain the lifting procedure to the user/patient.

### **WARNING!**

Do not attempt to transfer a patient without prior approval of the patient's nurse. Also, do not transfer without having studied the instructions and practiced operating the product several times. Together with the patient's doctor, nurse, or medical attendant, select a Proactive Medical Products sling that is both practical and comfortable. The sling selected should be one that serves the needs of the patient, while providing the patient with optimal safety. Never interfere with the lift, unless instructed by the attendant. Have a doctor, nurse, or medical attendant present during the first few times the lift is used to transfer a new user.

### **WARNING!**

Proactive Medical slings are specially designed to be used in conjunction with Proactive lifts. Do not use slings manufactured by other companies with any of Proactive Medical's equipment. **USING OTHER MANUFACTURER'S SLINGS ON THIS EQUIPMENT IS UNSAFE AND MAY RESULT IN SERIOUS INJURY TO USERS AND CAREGIVERS. PROACTIVE MEDICAL is not responsible for any consequence resulting from the use of non-Proactive slings on this equipment.**

### **WARNING!**

Do not put anything (e.g. cushion, pad, etc.) between the user and the sling. This may cause the user/patient to slide out of the sling and cause injury.

### **WARNING!**

Avoid personal injury by making sure no children or pets are near the Protekt® 600 Lift while it is in motion.

### **WARNING!**

Avoid personal injury by making sure all extremities (such as fingers, arms, legs, or feet) are clear of the lift mechanism while it is in operation.

## **WARNING!**

**Avoid personal injury and possible damage to the Propekt® 600 Lift by making sure the maximum weight limit of 600 lbs. is not exceeded.**

## **WARNING!**

**Replace any worn parts with only genuine Proactive Medical parts. The patient lift parts are not interchangeable with parts from other patient lift brands. Using other patient lift parts on these products is unsafe and may result in serious injury to user and caregiver. Proactive Medical is not responsible for any consequence resulting from the use of non-Proactive parts and components.**

## **WARNING!**

**Avoid personal injury by making sure the electrical connector is disconnected before conducting any electrical inspection. Contact your dealer if any electrical problem is detected.**

## **WARNING!**

**Service and repair of this equipment should be performed only by an authorized dealer. Proactive Medical is not responsible for any consequence resulting from any unauthorized service or repair.**

## **CAUTION**

**Avoid damage to the Propekt® 600 Lift by keeping foreign objects from coming into contact with the lift mechanism.**

## **NOTE**

**Arrange all necessary items (lift, slings, commode chair or wheel-chair) for a smooth procedure. The user/patient being transferred should be positioned in the center of the bed before being lifted, as well as when he/she is returned to the bed. Keep lifter base widened and brakes locked during lifting.**

# ASSEMBLY INSTRUCTIONS

## WARNING!

The lift is heavy! Therefore, avoid injury and **DO NOT** attempt to remove the lift from the box without any assistance.

### 1. Stand Mast from base.

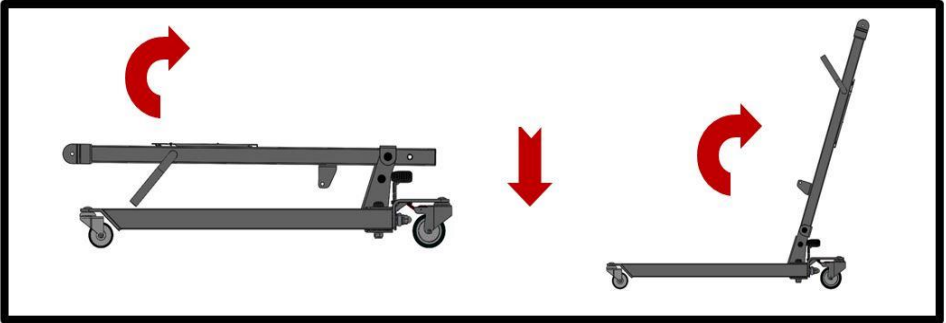

### 2. Tighten mast to base with bolts and nuts provided.

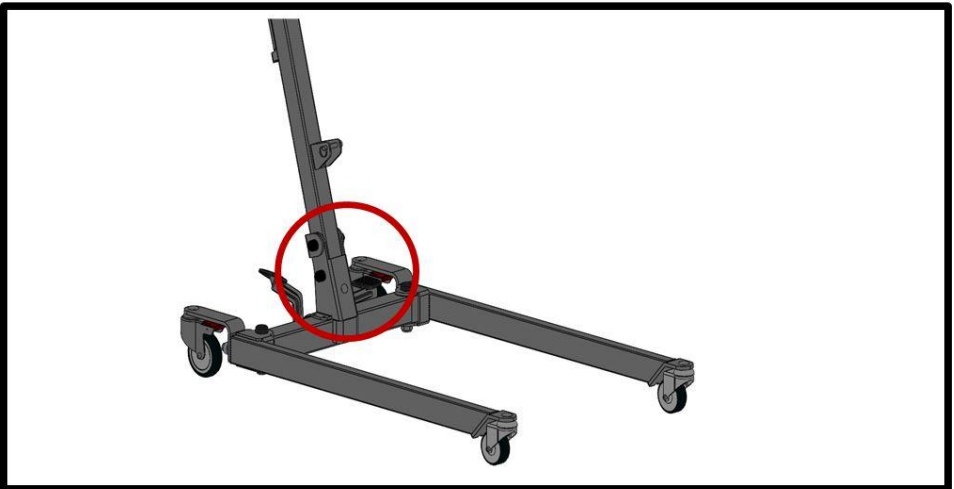



**3. Attach boom to top of mast.**

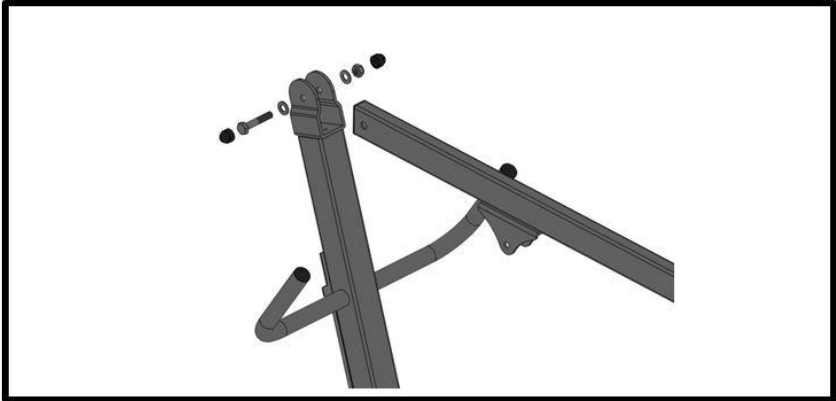

**4. Attach spreader bar to front of boom.**

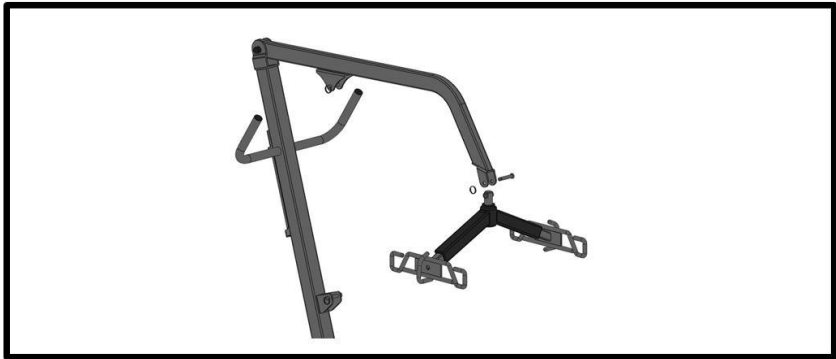

**5. Attach Actuator to mast and boom.**

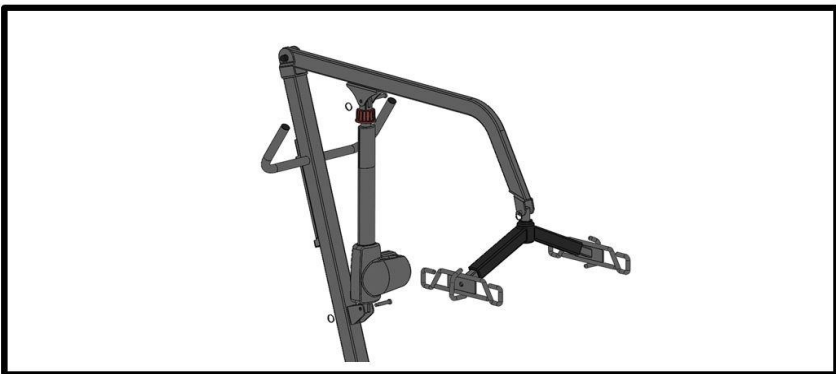

6. Attach the control box bracket to the mast with the two screws, then attach the control box to the mast with the two screws, then slide the battery in until it snaps into place, as shown above.



## MAINTENANCE & INSPECTION CHECK LIST

The operator of the lift is to inspect the Protekt® 600 Lift before each use. Check all bolts for tightness. Make sure the base can be easily widened, and that all lift parts are in place. Make sure all casters turn freely, and that the caster brakes can be engaged. Make certain all necessary items (i.e. slings, wheel chairs, etc.) are accessible and ready for use.

Check the battery capacity. See instructions below. At least once a month, the lift should be thoroughly inspected by a person qualified to recognize any signs of wear, and looseness of bolts or parts. Replace any worn parts immediately.

To lubricate, place a drop of oil on the following points when the Protekt® 600 Lift is serviced and every month thereafter- Top of Mast, Spreader Hinge, and Caster Axles.

## USER GUIDE

### CHARGING THE BATTERY -

The lift can be charged by plugging the charger directly into the control box while it is attached to the lift

*Or*

The battery pack can be charged while seated in the (optional) wall/desk charging caddy.

### OPERATING INSTRUCTIONS — USING THE CONTROL BOX

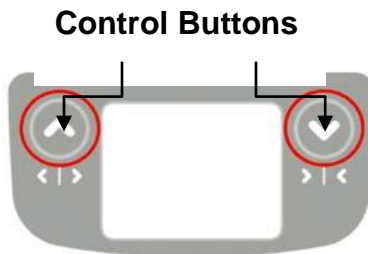

1. If you press either control button (shown at right) for less than 0.5 seconds, you can access the screens shown below.

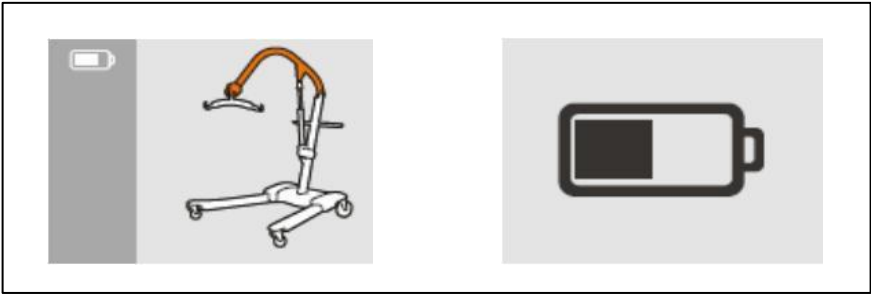





2.





<p><b>L - Left button</b></p> <p>Pressing the left button for more than 0.5 seconds will begin actuator extension.</p>		<p><b>R - Right button</b></p> <p>Pressing the right button for more than 0.5 seconds will begin actuator retraction.</p>
--	--	---



<p><b>Raise / Lower Lift</b></p>	<p>Long press to raise lift </p> <p>Long press to lower lift </p>	
----------------------------------	---	--

3. Press the  button to raise or the  button to lower the lift.

# OPERATING INSTRUCTIONS — USING THE HAND PENDANT

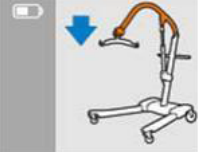









<p><b>Raise / Lower Lift</b></p>  	<p>Long press to raise lift</p>   <p>Long press to lower lift</p> 	 
--	--	---

1. Press the  button to raise or the  button to lower the lift.

# MAINTENANCE SCHEDULE

Item	In the Beginning	Monthly	Every 3 Months
<p><b>Boom &amp; Spreader Bar:</b>            Check connections between 1) Boom and Spreader Bar and 2) Boom and Mast for improper connection, looseness, or wear.            Check the Boom for bending and deflection.</p>	<p>●</p> <p>●</p>	<p>●</p> <p>●</p>	
<p><b>Mast:</b>            Check the Mast for bending or deflection.            Check the steering bar for damage or loose screws.</p>	<p>●</p> <p>●</p>	<p>●</p> <p>●</p>	
<p><b>Base &amp; Foot Peddle:</b>            Check bolts and nuts for looseness.            Check casters and axle bolts for tightness.            Check rubber parts on the casters for deflection.            Apply grease to caster ball bearings if needed.</p>	<p>●</p> <p>●</p> <p>●</p>	<p>●</p> <p>●</p>	<p>●</p> <p>●</p>
<p><b>Cleaning:</b>            As needed.</p>			<p>●</p>
<p><b>Actuator &amp; Control Box:</b>            Make sure the control box is firmly affixed to the mast.            Make sure the pins firmly affix actuator to the Boom and the Mast.</p>	<p>●</p> <p>●</p>	<p>●</p> <p>●</p>	

<p>Make sure the connecting cable of the actuator and the control box is not loose.</p>			
<p>Make sure the Battery has capacity prior to use.</p>			
<p><b>Slings &amp; Sling Hardware:</b></p> <p>Check sling for wear.</p> <p>Check sling hardware every time before use.</p>	 	 	

## OPERATING INSTRUCTIONS

**NOTE: Turn the lift "ON" by turning the red "RESET" button clockwise. Turn the lift "OFF" by pressing down the "RESET" button.**

### Transfer From Bed

- User/patient should be in the center of the bed.
- Position user onto his/her side by rolling user towards you.
- Roll the sling in half, approximately. The handle on the back section should face outward when the sling is fitted.
- Position the sling under the user/patient so the commode aperture aligns with the base of the spine and top of the sling close to the neck.
- Roll user onto the opposite side and position him/her on the flat section of the sling. This will allow you to unroll the remainder of the sling from the other side of the user.
- Once the sling has been positioned centrally, feed the leg sections under the thighs and draw them up between the thighs.
- Raise the head of the bed if this function is available.
- Move the lift slowly towards the user and position the spreader bar over the user's/patient's chest.

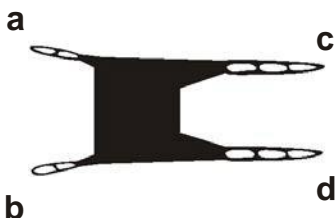



- Lift the user above the bed by using the hand control.
- Pull lift away from bed. Position user over the wheelchair or chair then lower the patient onto the surface.

**Note: Reverse the above procedures when returning the user/patient to bed.**

## **Transfer From Wheelchair**

- Grasp the sling at each corner of the "U" shape of the commode aperture.
- The sling should be fitted with the handle on the back section facing outward.
- Help the user lean forward slightly, then slide the sling down between the chair and the user's back.
- Position the commode aperture where the buttocks meets the seat.
- Position the sling equally around both sides of the body.
- Draw the leg sections to the front along the length of the user's thigh.
- Check the sling's central positioning by comparing the lengths of the leg sections when they are drawn forward.
- Reposition the sling if the leg sections are not equal in length.
- Feed the leg sections under the thighs.
- From between the legs, gently pull the leg section up the inner thigh.

- Feed as much material as possible under and between the thighs. Ensure the leg sections are positioned midway under the thighs to provide good support and greater comfort.
- Move the lift slowly towards the user and position the spreader bar over the user's chest.
- Attach Loop a of sling to Hook A on Spreader Bar; attach Loop b to Hook B; attach Loop c to Hook C; attach Loop d to Hook D.
- Lift patient above the wheelchair by using the hand control.
- Pull lift away from wheelchair. Position patient over bed and lower patient onto it.

**Note: Reverse the above procedures when returning the user/patient to a wheelchair.**

### **WARNING!**

**Use ONLY Proactive Medical slings/products with this equipment.**

#### **REPLACEMENT PARTS**

LP-33600-HPK	Replacement Hardware Pack f/ Protekt 33600 Lift
LP-33600-TA12-ACT	Replacement Actuator f/ Protekt Lift 33600 (600lb Cap.)
LP-FC	Replacement Front Caster f/ Protekt Lift/Stand
LP-RC	Replacement Rear Locking Caster f/ Protekt Lift/Stand
LP-TBC2-CRDL	Battery Charger Cradle ONLY (no plug) f/ Protekt Lift/Stand
LP-TBC2-CRDL-PK	Battery Charger Cradle Pack (includes plug) f/ Protekt Lift/Stand
LP-TC12-BPAK	Replacement Battery Pack f/ Protekt Lift/Stand
LP-TC12-CBOX	Replacement Control Box f/ Protekt Lift/Stand
LP-TMH3-PEN	Replacement Hand Pendant f/ Protekt Lift/Stand
LP-TP7C-ADP	Replacement Plug f/ Protekt Lift/Stand

## Full Body Mesh Slings

ITEM #	DESCRIPTION
30110 <i>Medium</i>	Mesh full body: medium 600 lb. weight capacity
30111 <i>Large</i>	Mesh full body: large 600 lb. weight capacity
30124 <i>X-Large</i>	Mesh full body: X-large 600 lb. weight capacity
30118 <i>XX-Large</i>	Mesh full body: XX-large 600 lb. weight capacity

## Full Body Mesh Slings w/Commode

ITEM #	DESCRIPTION
30114 <i>Medium</i>	Mesh full body: medium w/commode opening 600 lb. weight capacity
30115 <i>Large</i>	Mesh full body: large w/commode opening 600 lb. weight capacity
30116 <i>X-Large</i>	Mesh full body: X-large w/commode opening 600 lb. weight capacity
30119 <i>XX-Large</i>	Mesh full body: XX-large w/commode opening 600 lb. weight capacity

## Full Body Solid Slings

ITEM #	DESCRIPTION
30112 <i>Medium</i>	Solid fabric full body: medium 600 lb. weight capacity
30113 <i>Large</i>	Solid fabric full body: large 600 lb. weight capacity
30117 <i>X-Large</i>	Solid fabric full body: X-large 600 lb. weight capacity
30123 <i>XX-Large</i>	Solid fabric full body: XX-large 600 lb. weight capacity

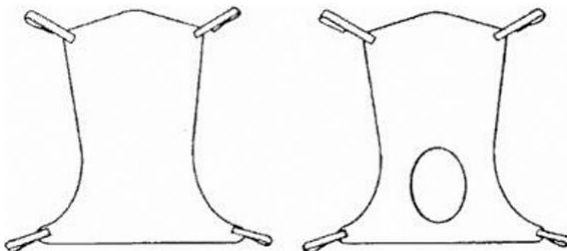

Divided leg design is best suited for high level spinal cord injuries or patients where sling removal is more difficult. Support ranges from the upper back to beneath the thighs. Can be positioned with patient seated. Greatly simplifies the use of bathroom facilities.

## Divided Leg Slings

ITEM #	DESCRIPTION
30100P <i>Small</i>	Solid divided leg: small 450 lb. weight capacity
30100 <i>Medium</i>	Solid divided leg: medium 450 lb. weight capacity
30101 <i>Large</i>	Solid divided leg: large 450 lb. weight capacity
30102 <i>X-Large</i>	Solid divided leg: X-large 450 lb. weight capacity
30103 <i>XX-Large</i>	Solid divided leg: XX-large 600 lb. weight capacity

## Padded Divided Leg Slings w/o Head Support

ITEM #	DESCRIPTION
30100P-NHS <i>Small</i>	Solid padded divided leg w/o head support: small 600 lb. weight capacity
30100-NHS <i>Medium</i>	Solid padded divided leg w/o head support: medium 600 lb. weight capacity
30101-NHS <i>Large</i>	Solid padded divided leg w/o head support: large 600 lb. weight capacity
30102-NHS <i>X-Large</i>	Solid padded divided leg w/o head support: X-large 600 lb. weight capacity

## Padded Divided Leg Slings w/Head Support

ITEM #	DESCRIPTION
30100P-HS <i>Small</i>	Solid padded divided leg w/head support: small 600 lb. weight capacity
30100-HS <i>Medium</i>	Solid padded divided leg w/head support: medium 600 lb. weight capacity
30101-HS <i>Large</i>	Solid padded divided leg w/head support: large 600 lb. weight capacity
30102-HS <i>X-Large</i>	Solid padded divided leg w/head support: X-large 600 lb. weight capacity



## TROUBLE SHOOTING

<b><i>Symptom:</i></b>	<b><i>Corrective Action:</i></b>
Cannot lift patient up and battery indicator shows no GREEN light.	<ol style="list-style-type: none"> <li>1. Charge the batteries until all green lights are on.</li> </ol>
Lift does not work and the battery indicator shows a full charge.	<ol style="list-style-type: none"> <li>1. Check connection between the actuator and the control box.</li> <li>2. Check connection between the pendant &amp; control box.</li> <li>3. Contact your dealer if problem persists.</li> </ol>
Lift does not work and the battery indicator shows no light.	<ol style="list-style-type: none"> <li>1. Make sure the emergency stop button is released.</li> <li>2. Check connection of the batteries in the control box.</li> <li>3. Contact your dealer if problem persists.</li> </ol>
Stops-and-Runs while lifting or lowering user.	<ol style="list-style-type: none"> <li>1. Check socket for pendant plug-in.</li> <li>2. Check pendant cable.</li> <li>3. Charge the batteries. Replace bad batteries.</li> <li>4. Contact your dealer if problem persists.</li> </ol>
Battery Indicator shows no light when charger is connected to power supply.	<ol style="list-style-type: none"> <li>1. Check if emergency stop button is released.</li> <li>2. Check charger plug for damage.</li> <li>3. Check charger cable for damage.</li> <li>4. Replace bad batteries.</li> <li>5. Contact your dealer if problem persists.</li> </ol>

**WARNING:** If you experience a problem with your lift and are unable to service it yourself, contact Proactive Medical or your Proactive authorized distributor.

## LIMITED WARRANTY

The Protekt® 600 Lift you purchased is guaranteed to be free from defects in material and workmanship under normal use and service. The warranty period for this product is 2 Years Electronics/3 Years Frame from the date of purchase by the original purchaser. This warranty shall be voided upon transfer of ownership of this product. Proactive Medical agrees to repair or replace this product, at our discretion and at no charge, within the warranty period provided and that Proactive Medical consents the unit is defective. The repaired or replacement unit shall be warranted for a period equal to the balance of the defective unit's warranty period.

### NOTE:

To ensure the best service to our customers, Proactive Medical requires the following information to be included with the returned unit:

1. Model Name/Number and Serial Number on the packaging.
2. Proof of purchase, i.e. a copy of the original invoice.
3. A Return Authorization number (RA#) obtained by calling Authorized dealer/distributor prior to the return of the product. The RA# must be clearly indicated on the outside of the packaging.
4. A detailed description of the problem and its symptoms on a note.

This warranty shall not apply to any product which has been repaired or altered in any way so as, in our judgment, to affect its functionality and durability, nor to any product subject to abuse, misuse, negligence or accident, improper maintenance, improper installation, nor to any product used with other parts, components and/or accessories with quality and/or specifications not compatible with this product. This warranty does not cover products that have been impaired by occurrences considered Acts of God over which authorized dealer has no control. This warranty shall also be voided if any required periodic maintenance, if applicable, has not been properly performed on this product.

This warranty and the aforementioned remedies presented are exclusive and in lieu of all other express or implied warranties. No other representations or claims shall be binding or obligate authorized dealer in any way. Any warranty applicable to this product is limited to the aforementioned period indicated. In no event shall authorized dealer be liable for any special, incidental, or consequential damages; loss of revenue; or cost of replacement goods; resulting from the use or malfunction of this product to the associated equipment on which and with which it is used. This warranty gives specific legal rights and you may be entitled to other rights that vary from state to state.