

# USE AND CARE GUIDE

## LED LINEAR DIMMABLE STRIP LIGHTS

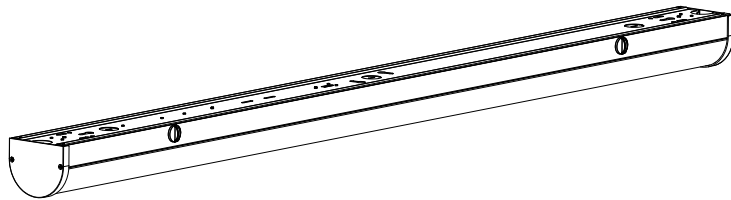

## Safety Information

**WARNING:**Carefully read and understand the information give in this manual before beginning the assembly and installation. Failure to do so could lead to electric shock, fire,or other injuries which could be hazardous or even fatal.

**WARNING:**Ensure the electricity to the wires you are working on is shut off. Either remove the fuse or turn off the circuit breaker.

**WARNING:**1.Suitable for operation in not exceeding 45°C  
2. Minimum 75°C supply conductors  
3. Caution-risk of shock. Disconnect power before servicing  
4. This product must be installed in with the applicable installation code by a accordance person familiar with operation of the product and the hazards cinstruction and

**WARNING:**Changes or modifications not expressly approved by the party responsible for compliance could void the user's authority to operate the equipment.

**WARNING:**This device complies with part 15 of the FCC Rules. Operation is subject to the following two conditions: (1)this device may not cause harmful interference,and (2)this device must accept any interference received,including interference that may cause undesired operation. Changes or modifications not expressly approved by the party responsible for compliance could void the user's authority to operate the equipment.

**NOTE:** This equipment has been tested and found to comply with the limits for a Class B digital device, pursuant to Part 15 of the FCC Rules. These limits are designed to provide reasonable protection against harmful interference in a residential installation. This equipment generates, uses and can radiate radio frequency energy and, if not installed and used in accordance with the instructions, may cause harmful interference to radio communications. However, there is no guarantee that interference will not occur in a particular installation. If this equipment does cause harmful interference to radio or television reception, which can be determined by turning the equipment off and on, the user is encouraged to try to correct the interference by one or more of the following measures:

- -- Reorient or relocate the receiving antenna.
- -- Increase the separation between the equipment and receiver.
- -- Connect the equipment into an outlet on a circuit different from that to which the receiver is connected.
- -- Consult the dealer or an experienced technician for help.

## Warranty

This warranty shall not apply to any product that is found to have been improperly installed, set-up ,or used in any way not in accordance with the instructions supplied with the product. This warranty shall not apply to a failure of the product as a result of an accident, misuse, abuse, negligence, alteration, faulty installation, or any other failure not relating to faulty material or workmanship. This warranty shall not apply to the finish on any portion of the product, such as surface and/or weathering, as this is considered normal wear and tear.

The manufacturer does not warrant and specifically disclaims any warranty, whether express or implied, of fitness for a particular purpose, other than the warranty contained herein. The manufacturer specifically disclaims any liability and shall not be liable for any consequential or incidental loss or damage, including but not limited to any labor/ expense costs involved in the replacement or repair of said product.

## Installation method complying with American standard

Before beginning assembly, installation or operation of product, make sure all parts are present. Compare parts with package contents list on previous page. If any part is missing or damaged, do not attempt to assemble, install or operate the product. Contact customer service for replacement parts. Select suitable location that can support the weight of the fixture. Determine method of mounting before drilling.

### 1.Take out the back plate.

Take out the back plate by rotating the plastic buckles of the lamp body on the side.

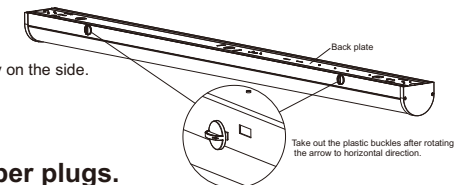

### 2.Fix the wiring connection of the rubber plugs.

Drill 2 holes on the installation surface and hammer the plastic expansion bolt into the hole and ensure that the plastic expansion bolt does not fall off. Prize up the reserved holes on the back plate and thread the power cord through the lamp. Use wiring cap to connect with the power supply. The black is connected with the live line; the wire is connected with the null line. The yellow green line is connected with the grounding line.

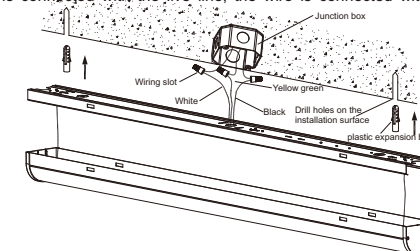

### 3. Fix the back plate

Put the connected wire into the junction box. Then use self-tapping screws to lock it on the installation surface tightly.

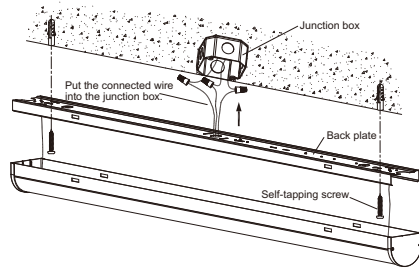

### 4. Fix the lamp body

Use four plastic buckles to fix the lamp body on the back plate. Put the buckles into the square holes to rotate 90 degrees (note: after installation is completed, the arrow must be at the vertical direction to lock the lamp body).

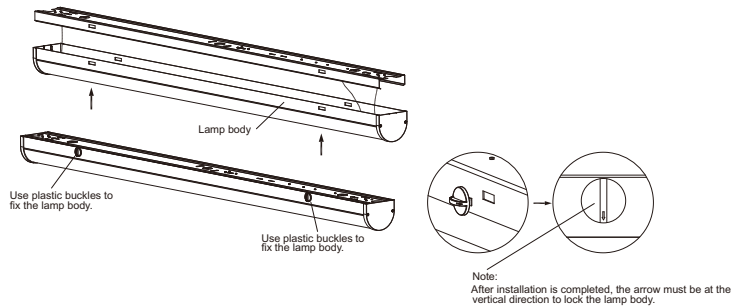

## Installation method implying with European standard

Before beginning assembly, installation or operation of product, make sure all parts are present. Compare parts with package contents list on previous page. If any part is missing or damaged, do not attempt to assemble, install or operate the product. Contact customer service for replacement parts. Select suitable location that can support the weight of the fixture. Determine method of mounting before drilling.

### 1. Take out the back plate.

Take out the back plate by rotating the plastic buckles of the lamp body on the side.

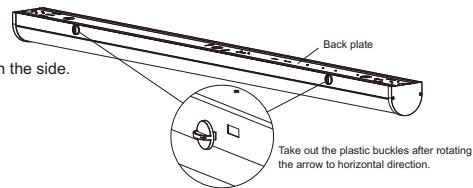

### 2. Fix the back plate

Drill 2 holes on the installation surface and hammer the plastic expansion bolt into the hole and ensure that the plastic expansion bolt does not fall off. Prize up the reserved holes on the back plate first. Then connect the electricity into the lamp. Then use self-tapping screws to fix the back plate on the installation surface.

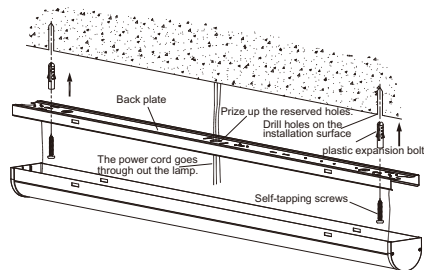

### 3. Wiring

Connect the line of power supply into the terminal block as shown in the figure. The live line is connected with L and null line is connected with N and the grounding line is connected in the middle.

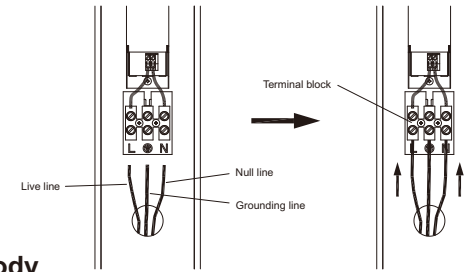

### 4. Fix the lamp body

Use four plastic buckles to fix the lamp body on the back plate. Put the buckles into the holes to rotate 90 degrees (note: after installation is completed, the arrow must be at the vertical direction to lock the lamp body).

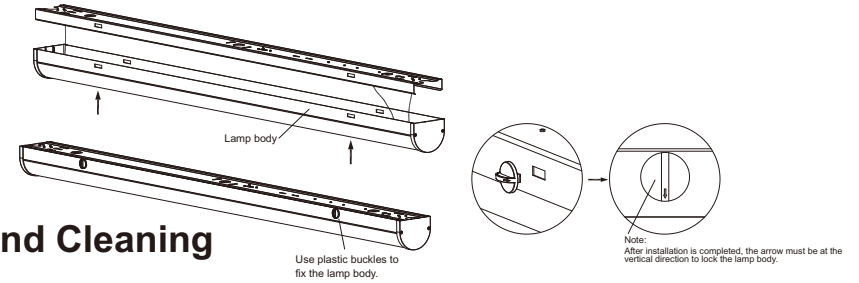

## Care and Cleaning



**CAUTION:** Before attempting to clean the fixture, disconnect the power to the fixture by turning the breaker off or removing the fuse from the fuse box. Clean the fixture with a soft, dry cloth. Do not use any cleaners with chemicals, solvents, or harsh abrasives.

## Troubleshooting

Problem	Possible Cause	Corrective Action
The fixture will not light.	The power is off.	Ensure the power supply is on.
	The circuit breaker is off.	Ensure the circuit breaker is in the on position.
The fuse blows or the circuit breaker trips when the light is turned on.	The wires are crossed or the power wire is grounding out.	Check the wire connections. Contact a qualified electrician or call the Customer Service Team at +86 755 2809 3844

## Notice

- Before using, please read the instructions carefully, to ensure the operating condition meet product using requirements and relevant technical specification;
- Prohibit operating with power. Must power off before contact with lamp to avoid electric shock;
- After open the packaging, before use, please check whether the lamp is damaged during transportation or not. If the lamp is damaged, please stop application and inform supplier; the product can only be used in undamaged condition;
- To ensure product safe and applicable, please conform to instructions to perform installation and operation; supplier is not liable for any losses caused by illegal operation.