

Niche™ Duo

83F Coffee Grinder

User Manual

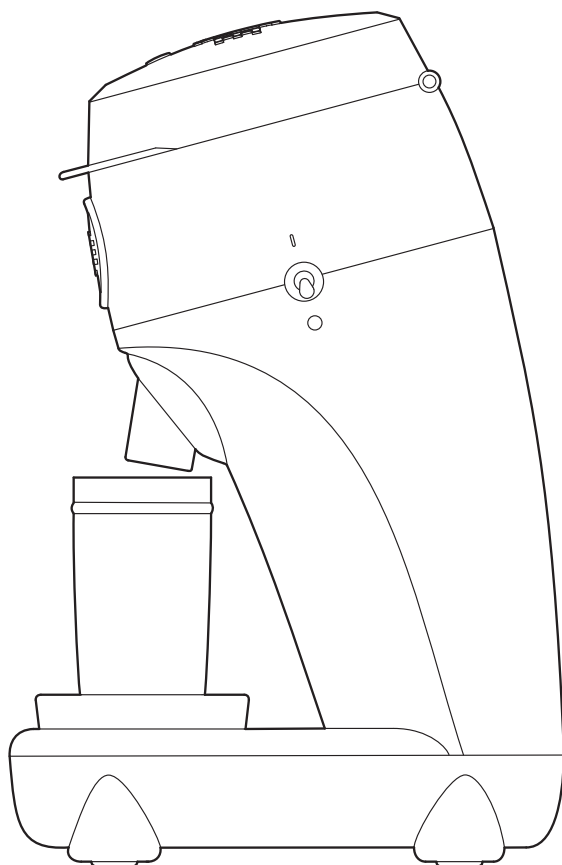

Scan to get started with your Niche Duo

Contents

Introduction	4-5
Important Safeguards	6-8
Electrical Safety	9
First Use of the Grinder	10
Using the Grinder	11-12
Changing the Burrs	13-15
Care and Cleaning	16-17
Zeroing the Niche Duo	18-23
Troubleshooting	24
Additional Information	25
Guarantee	26
Warranty	27

Introduction

Thank you for purchasing the Niche Duo. The Niche Duo is a domestic coffee grinder, intended for use with two specialised sets of 83mm flat burrs - one set engineered for exceptional espresso and the other set for flawless filter brewing.

Please take a moment to familiarise yourself with the diagrams on these pages - the terminology is used later in these instructions.

Espresso Burr Set (Black)

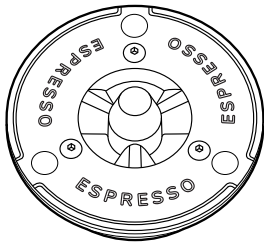

Upper
burr carrier

Filter Burr Set (Blue)

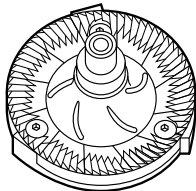
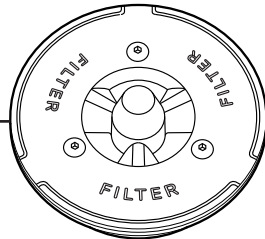

Lower
burr carrier

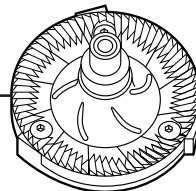

IMPORTANT: YOUR NICHE DUO HAS BEEN ZEROED DURING MANUFACTURE AND IS READY TO USE IMMEDIATELY. 'ZEROING' DESCRIBES THE PROCESS OF ALIGNING THE BURRS SO THE '0' MARK ON THE GRIND DIAL REFERS TO THE POSITION WHERE THE BURRS JUST BEGIN TO TOUCH. ZEROING YOUR NICHE DUO IS NOT NECESSARY, EVEN WHEN CHANGING BETWEEN THE BURR SETS OR CLEANING. PLEASE SEE THE 'ZEROING THE NICHE DUO' SECTION FOR MORE INFORMATION.

Introduction

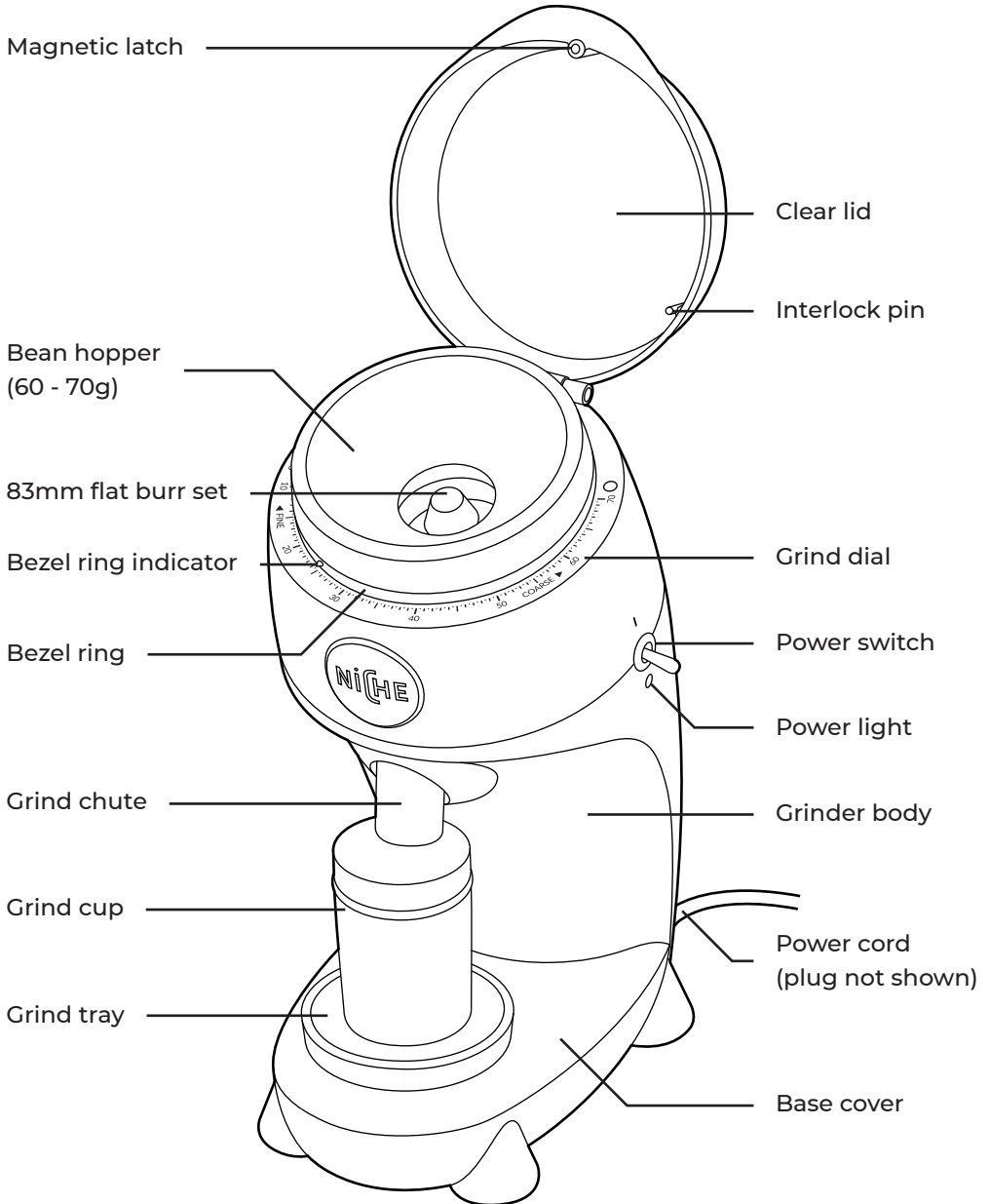

Important Safeguards

When using electrical appliances, basic safety precautions should always be followed, including the following. **READ ALL INSTRUCTIONS BEFORE USING THE NICHE DUO 83MM FLAT BURR COFFEE GRINDER, HEREINAFTER REFERRED TO AS THE 'NICHE DUO' OR 'GRINDER'.**



WARNING: MISUSE OF THIS APPLIANCE MAY CAUSE INJURY.

1. Before using the Niche Duo for the first time, please ensure that your electricity supply is the same as shown on the rating label on the underside of the grinder. If you have any concerns, please contact your local electricity company.
2. If the power cord or plug is damaged, the appliance malfunctions, or it has been damaged in any manner; it must be replaced or repaired by the manufacturer, its service agent or a similarly qualified person(s) in order to avoid a hazard.
3. Any plug cut from the power cord should be disposed of immediately. Inserting a cut-off plug into an electrical socket is dangerous.
4. The Niche Duo features an overheat cut-out that cuts the power if it overheats. If this occurs, unplug the grinder. The safety cut-out will automatically reset itself after 1 hour and power will be restored when the grinder is plugged in again.
5. Do not place the Niche Duo on or near a gas or electric burner, or where it could touch a heated surface.
6. Any significant spillage onto the surface under, around, or onto the Niche Duo itself, should be cleaned and dried before using the grinder.

Important Safeguards

- 7.** To protect against electric shock and damage, do not immerse any part of the Niche Duo in water or allow moisture to come in contact with the internal components. Do not operate the grinder on a sink draining board.
- 8.** The burrs are extremely sharp; take extra care when handling, especially when removing from the body. Avoid touching the sharp edges and wear cotton gloves when handling the burrs.
- 9.** To avoid suffocation and choking hazards for young children, remove and safely dispose of the protective cover fitted on the power plug pins and any plastic bags.
- 10.** Avoid contact with moving parts. Do not attempt to defeat any safety interlock mechanisms.
- 11.** Always make sure the Niche Duo is properly assembled before use. The grinder will not operate unless properly assembled and the lid is closed.
- 12.** The Niche Duo is not intended for use by persons (including children) with reduced physical, sensory or mental capabilities, or lack of experience and knowledge, unless they are closely supervised and instructed concerning use of the grinder by a person responsible for their safety. Close supervision is necessary when any appliance is used by or near children. Children should be supervised to ensure that they do not play with the appliance.
- 13.** Before assembly, disassembly or cleaning, turn the Niche Duo OFF and unplug from the outlet. To unplug, grasp the plug and pull from the outlet. Once installed, ensure the grinder is OFF when not in use.
- 14.** Do not attempt to operate the Niche Duo by any method other than for which it is intended and described in this booklet.

Important Safeguards

- 15.** The Niche Duo is not intended to be operated by an external timer or separate remote control system.
- 16.** The use of attachments not recommended or sold by Niche Coffee may cause fire, electric shock or injury.
- 17.** Check the bean hopper for the presence of foreign objects before using.
- 18.** The Niche Duo is for household use only. Do not use the grinder for anything other than its intended use. Misuse may cause injury. If the grinder is used improperly or not used in accordance with these instructions, the guarantee will become invalid and Niche Coffee refuses to accept any liability for damage caused.
- 19.** Do not place the Niche Duo near a surface edge. Ensure the surface is level, clean and dry. Do not let the power cord hang over the surface edge, touch hot surfaces, or become knotted.
- 20.** The Niche Duo is only designed to grind whole roasted coffee beans. Do not attempt to grind any other foodstuffs; including herbs, spices and pre-ground coffee.
- 21.** Always disconnect the Niche Duo from a power supply if it is left unattended and before assembly, disassembly or cleaning. To unplug it, hold the plug and pull it out of the socket. Never pull it out by the power cord.
- 22.** Do not put the Niche Duo, or any of its parts in a dishwasher.
- 23.** Keep the Niche Duo clean. Refer to the 'Care and Cleaning' section.
- 24.** Do not use the Niche Duo outdoors.
- 25.** Never tamper with the safety mechanisms. They are included for your personal safety.

Electrical Safety

Input rating: 220-240V~ 50Hz 130W

Note

The Niche Duo has a grounded/earthed plug. To reduce the risk of electrical shock, this plug will only fit in an outlet one way. If the plug does not fit in the outlet, contact a qualified electrician. Do not modify the plug in any way. A power cord storage area is provided inside the grinder to help prevent cord tangling and to limit the risk of the cord becoming a trip hazard.

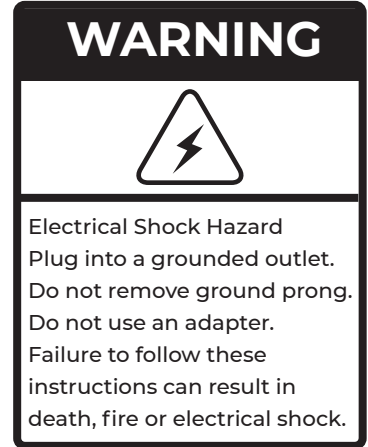

Disposal

The symbol shown to the right indicates that this appliance should not be disposed of in normal household waste. It should be taken to a local authority waste collection centre designated for this purpose. For more information, please contact your local authority.

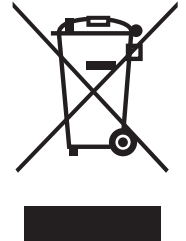

**SAVE THESE INSTRUCTIONS.
FOR HOUSEHOLD USE ONLY**

First Use of the Grinder



WARNING: DO NOT USE THE GRINDER SET AT '0' FOR SUSTAINED PERIODS AS THIS MAY DAMAGE THE BURRS.

1. Before use remove all packaging.
2. There may be coffee residue in your Niche Duo - this is from testing to make sure your grinder performs optimally.
3. **Your Niche Duo has been zeroed during manufacture and is ready to use immediately. 'Zeroing' describes the process of aligning the burrs so the '0' mark on the grind dial refers to the position where the burrs just begin to touch. Zeroing your Niche Duo is not necessary, even when changing between the burr sets or cleaning. Please see the 'Zeroing the Niche Duo' section for more information.**
4. Plug the Niche Duo into a power outlet. The power light will glow red to show power is present.
5. Your grinder comes with the black espresso burr set installed and has been adjusted to setting 10. Please see the 'Changing the Burrs' section for advice on changing the burr set.
6. If you require an extra coarse setting, you are able to continue rotating the bean hopper anticlockwise until you reach your desired setting. The grind dial markings are only a guide. We recommend you find the settings that work best for you.
7. Grind quality is good immediately, but see the 'Additional Information' section for more information about seasoning of the burrs.
8. You're now ready to begin using your Niche Duo. Please follow the instructions in the 'Using the Grinder' section.

Using the Grinder

1. Open the Niche Duo lid and check that the bean hopper is empty. Turn the entire bean hopper to adjust grind consistency, matching the bezel ring indicator to your desired setting on the grind dial. Turn clockwise for finer grinds and anticlockwise for coarser grinds. Ensure you do this with no beans in the bean hopper.

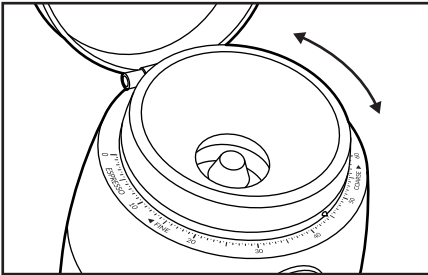

When adjusting for finer grinds, run the grinder for 1 second every time the bean hopper is rotated 10 marks on the grind dial. This ensures any trapped coffee between the burrs does not strain the mechanism and also makes adjusting easier.

2. Pour your beans into the supplied grind cup and weigh to check you have the correct amount. Ensure no foreign objects are present as these could damage the burrs. This is also a good time to remove any defective beans such as quakers (unusually light beans) and blacks (very dark beans).

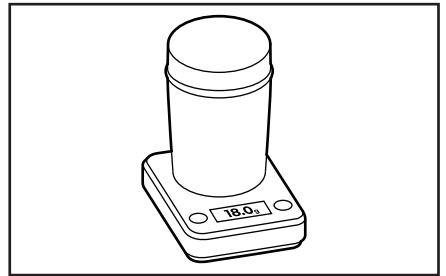

3. Open the lid and pour your beans into the bean hopper.

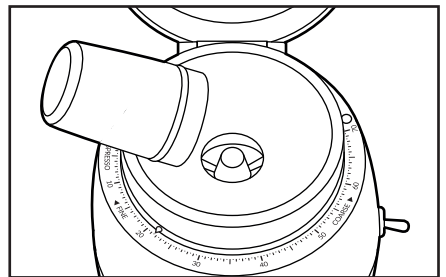

Using the Grinder

4. Replace the grind cup on the grind tray underneath.

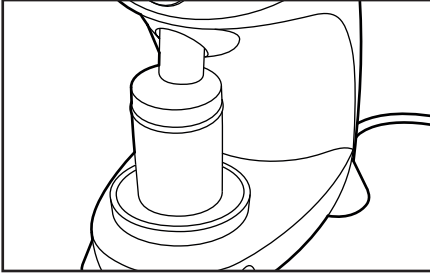

7. For espresso, fit your 58mm portafilter over the grind cup.

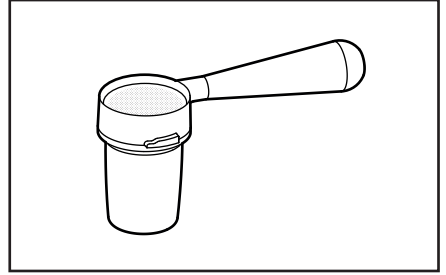

5. Close the lid (the Niche Duo will not operate if the lid is open) and flick the power switch up, to turn on.

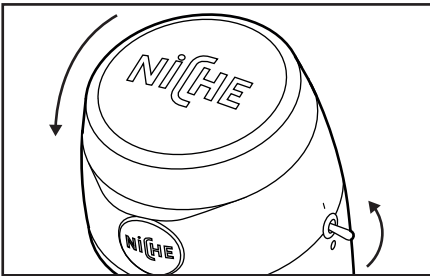

8. Invert the grind cup and portafilter together, shake and tap the grind cup, and then remove the grind cup.

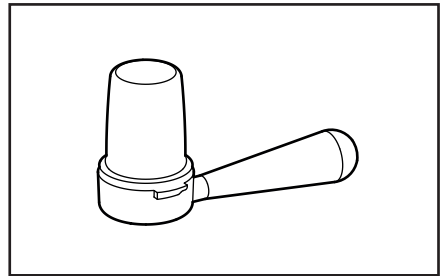

6. You will hear a change in motor noise when the Niche Duo has finished grinding. Leave the grinder running for 5 - 10 seconds, to make sure all the beans have been ground, before turning off.

9. For other brewing methods, pour the ground coffee directly from the grind cup into your chosen brewing equipment.

Changing the Burrs



WARNING: ALWAYS MAKE SURE THE GRINDER IS TURNED OFF AND UNPLUGGED WHEN NOT IN USE, BEFORE ASSEMBLING OR DISASSEMBLING PARTS AND BEFORE CLEANING. DO NOT TOUCH THE EXPOSED PART OF THE BURR ON EITHER CARRIER.

The Niche Duo has been designed for use with two specialist 83mm flat burr sets - a set dedicated to making exceptional espresso and another set optimised for making flawless filter coffee. Follow these instructions to switch between these two flat burr sets. Please do not touch the exposed burrs. We recommend wearing cotton gloves when handling the burrs.

Please note that the filter burr set has been specifically designed for filter coffee and cannot grind fine enough for espresso.

1. Rotate the bean hopper anticlockwise to unscrew. Place the bean hopper to one side.
2. Remove the upper burr carrier from the grind chamber and place to one side.

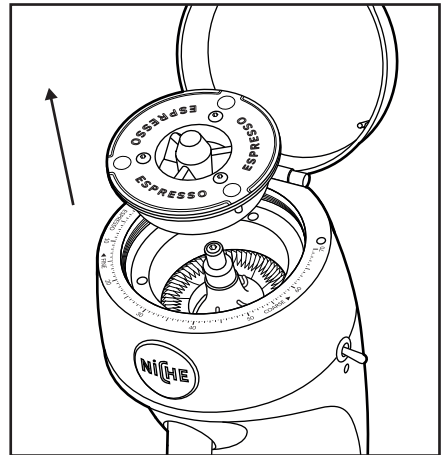
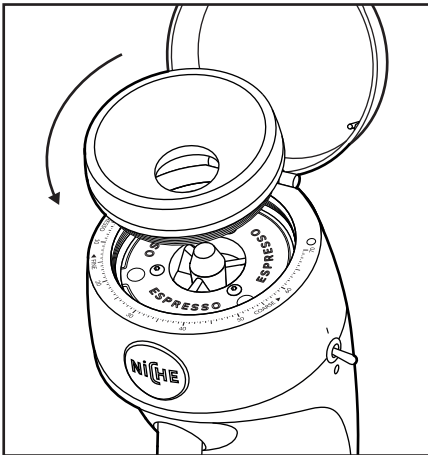

Changing the Burrs

3. Unscrew and remove the centre screw using the hex driver. Place the screw to one side.
5. Place the grind cup under the grind chute and clean the grind chamber.

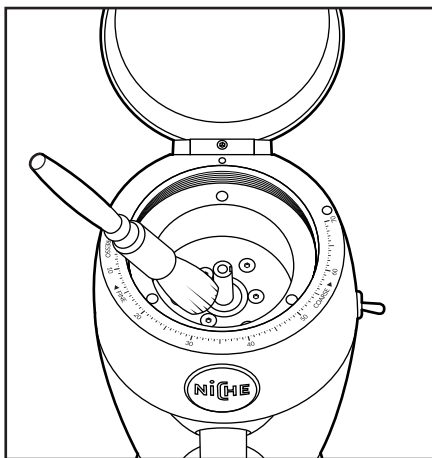
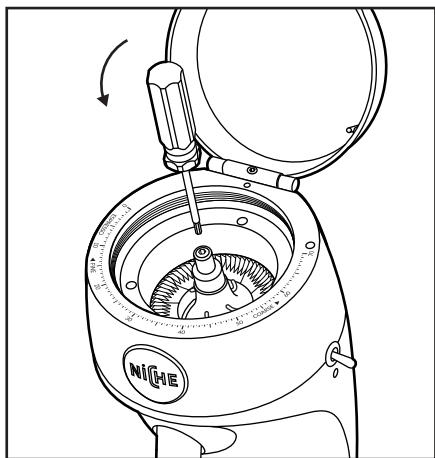

4. Remove the lower burr carrier from the grind chamber and place to one side.
6. Fit the lower burr carrier from the other set and rotate until it drops to the chamber base.

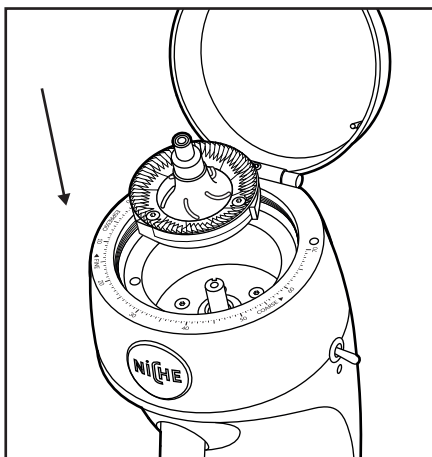
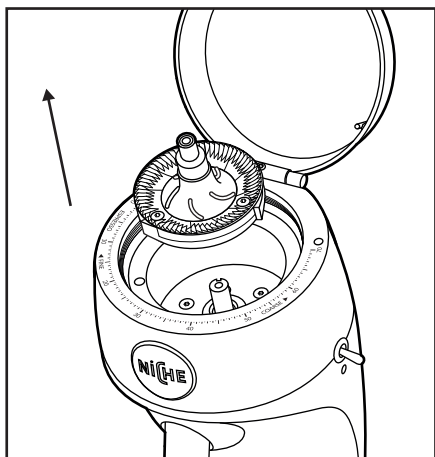

Changing the Burrs

7. Reseat the centre screw and tighten the screw using the hex driver.

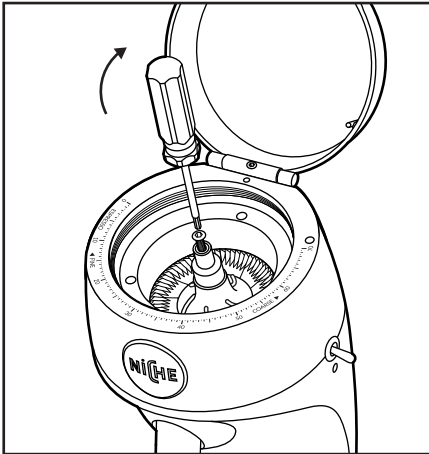

9. Reseat the bean hopper and screw clockwise until lightly hand tight.

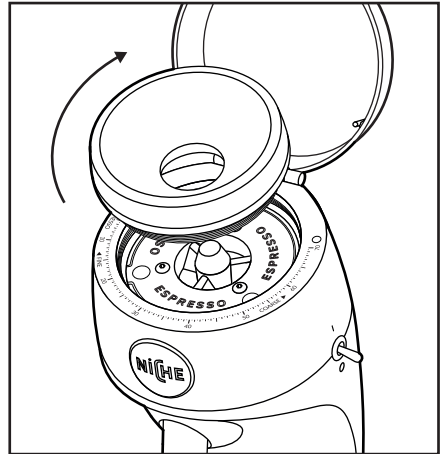

8. Align the three prongs on the other upper burr carrier to the holes inside the chamber.

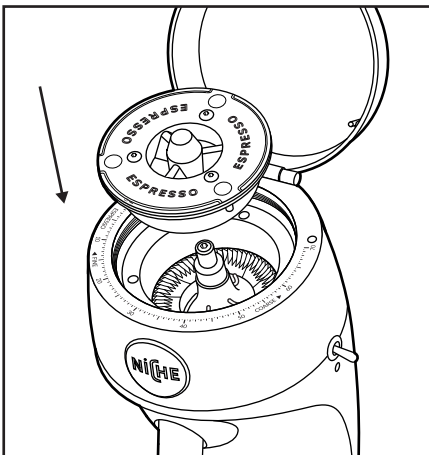

10. Turn the bean hopper to your desired grind setting. Your Niche Duo is now ready to use.

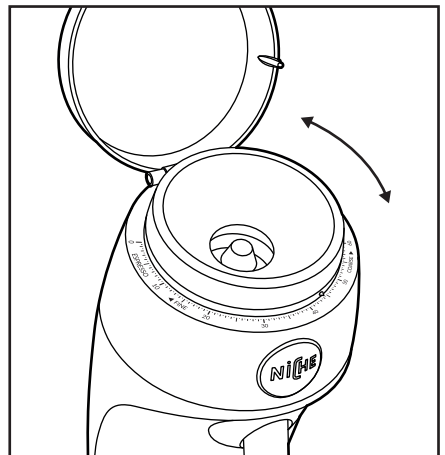

Care and Cleaning



WARNING: ALWAYS MAKE SURE THE GRINDER IS TURNED OFF AND UNPLUGGED WHEN CLEANING. DO NOT TOUCH THE EXPOSED PART OF THE BURR ON EITHER CARRIER.

1. Specialist cleaning products:

We do not recommend that rice or any other specialist cleaning products are run through the Niche Duo, as this may damage the burrs. The grinder is not designed to be cleaned this way. Do not use abrasive cleaners or scouring pads.

2. Cleaning the grinder body, bean hopper and wood:

Do not immerse any part of the Niche Duo in water. Wipe the grinder body, power cord and lid with a clean damp cloth and dry immediately with a soft microfibre cloth.

3. Cleaning the grind chute and grind cup:

Use the brush provided to clean the grind chute. This can be done by pushing the brush up the chute and twisting. The grind cup can be cleaned in hot soapy water. Do not place your grind cup in a dishwasher.

4. Cleaning the grind chamber:

Unscrew and remove the bean hopper. Remove the upper burr carrier. Remove the 3 springs if vacuuming. Use the brush to sweep any residual grind into the grind chute and collect in the grind cup. Reassemble the Niche Duo when finished.

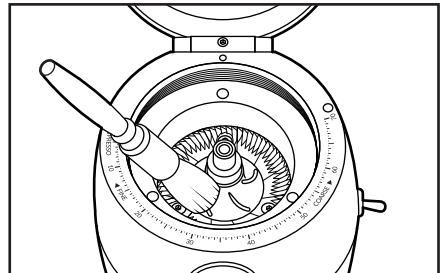

Care and Cleaning

5. Cleaning the burrs:

If the Niche Duo is used frequently, the burrs need to be cleaned regularly. Foreign objects sometimes find their way into whole bean coffee. These objects may cause the grinder to jam. Ensure the burrs are cleaned if this is the case.

Unscrew and remove the bean hopper followed by the burr carriers as detailed in the 'Changing the Burrs' section. Please do not touch the exposed burrs. We recommend wearing cotton gloves when handling the burrs. Remove the 3 springs below the upper burr carrier if vacuuming.

Clean both burr carriers with the brush supplied and then return the burr carriers to the grinder or the plastic case provided.

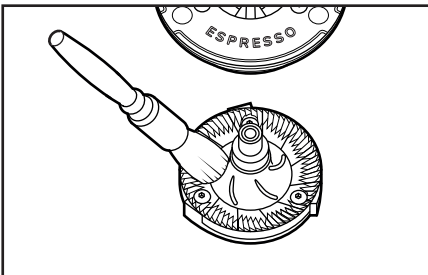

6. Deep cleaning:

We advise that you deep clean the Niche Duo every 3-6 months (depending on use).

Unscrew and remove the bean hopper followed by the burr carriers. Please do not touch the exposed burrs. We recommend wearing cotton gloves when handling the burrs.

Use a soft toothbrush to clean the burr grinding surfaces. A vacuum is optional but can help remove coffee you can't see. Remove the 3 springs below the upper burr carrier if vacuuming.

Use a soft damp cloth to clean the chamber. Clean the internal threads with a dry toothbrush and very lightly lubricate with food safe grease. Ensure the chamber is completely dry before reseating the burrs.

Use a soft microfibre cloth around a finger to clean the grind chute as high as possible.

Reassemble the Niche Duo and run 18g of coffee beans through the grinder and discard.

Zeroing the Niche Duo



WARNING: ALWAYS MAKE SURE THE GRINDER IS TURNED OFF AND UNPLUGGED WHEN REMOVING THE BEAN HOPPER. DO NOT TOUCH THE EXPOSED PART OF THE BURR ON EITHER CARRIER. ONCE ZEROED DO NOT USE THE GRINDER SET AT '0' FOR SUSTAINED PERIODS AS THIS MAY DAMAGE THE BURRS.

'Zeroing' describes the process of aligning the burrs so the '0' mark on the grind dial refers to the position where the burrs just begin to touch. **YOUR NICHE DUO HAS BEEN ZEROED DURING MANUFACTURE AND IS READY TO USE IMMEDIATELY. ZEROING YOUR NICHE DUO IS NOT NECESSARY, EVEN WHEN CHANGING BETWEEN THE BURR SETS OR CLEANING.**

These instructions explain how to zero your Niche Duo if you wish to do so. **ONLY PERFORM ZEROING WITH THE ESPRESSO BURR SET INSTALLED.**

1. Rotate the bean hopper anticlockwise and unscrew it from the body casting. Once removed, turn the bean hopper upside down.
2. Loosen the thumb screw located on the inside of the bean hopper. This releases the bezel ring lock, allowing you to adjust the bezel ring.

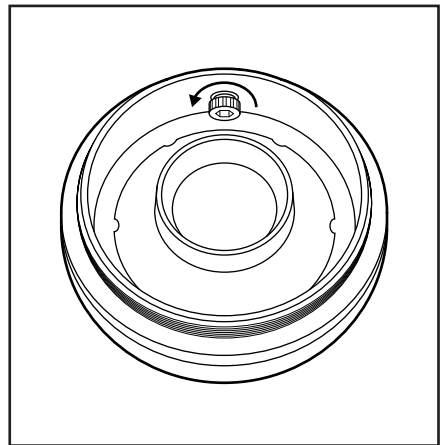
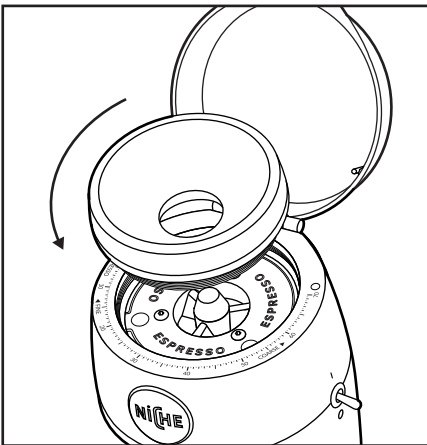

Zeroing the Niche Duo

3. Remove the upper burr carrier and ensure that the burrs, upper burr carrier and lower burr carrier are completely clean.

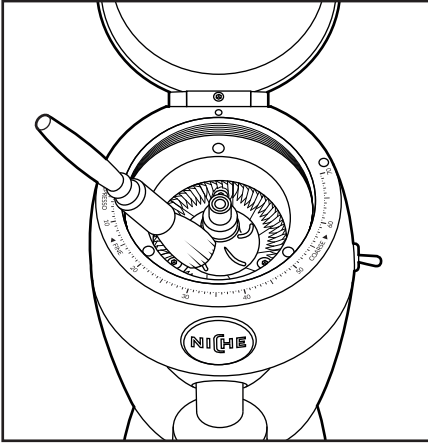

5. Reseat the bean hopper and screw clockwise until lightly hand tight.

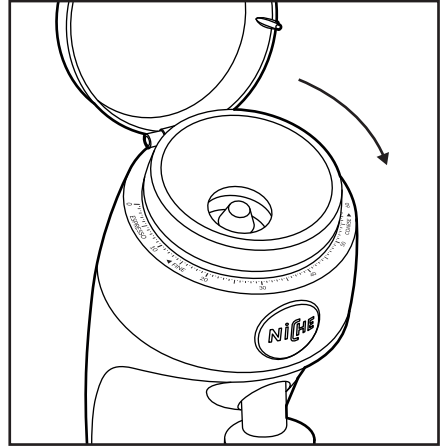

4. Only perform zeroing with the espresso burr set installed.

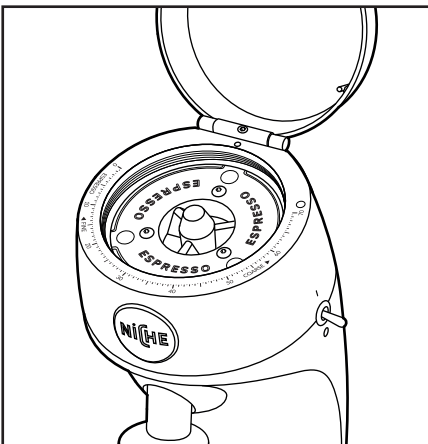

6. Rotate the bezel ring (black ring only) until the bezel ring indicator is aligned to '0'.

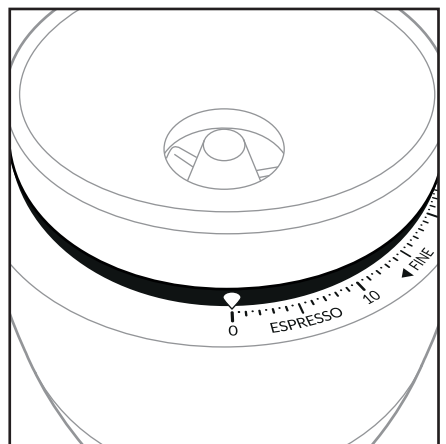

Zeroing the Niche Duo

7. Rotate the bean hopper anticlockwise until the bezel ring indicator is aligned to '20'.

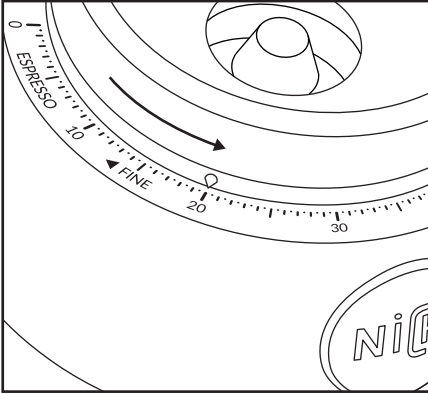

8. Turn on the grinder to hear what the grinder sounds like when the burrs are not touching.
9. Rotate the bean hopper clockwise so the bezel ring indicator moves by 2 marks.

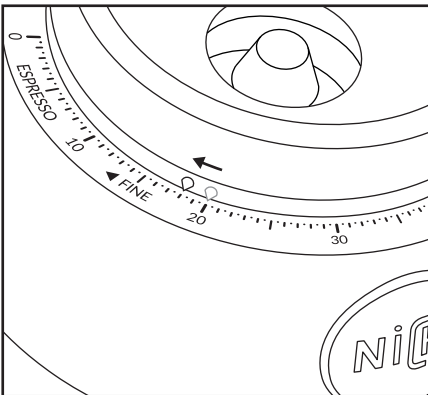

10. Close the lid and turn on the grinder for a few seconds. If the burrs sound like they are touching you are close to zeroing the burrs.
11. If there is no discernible change in noise please repeat steps 9 and 10 until you definitely hear the burrs touching.
12. Once the burrs are definitely touching, rotate the bezel ring (black ring only) until the bezel ring indicator is aligned to '0'. You should hear a clicking noise when turning the bezel ring.

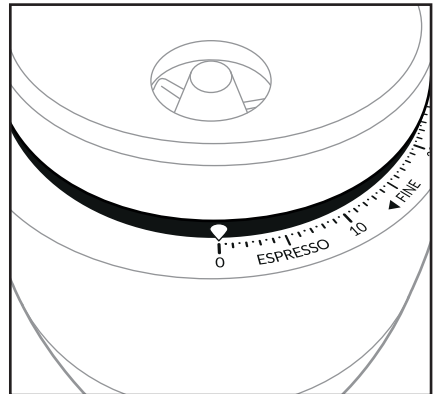

13. For optimum performance it is important to ensure the accuracy of the zero position.

Zeroing the Niche Duo

- 14.** To verify the accuracy, rotate the bean hopper a quarter turn anticlockwise (approx. 30 - 40 marks on the grind dial).

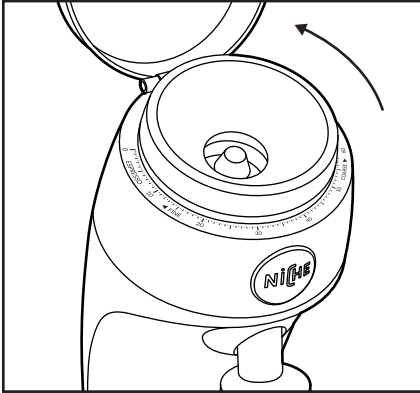

- 15.** Rotate the bean hopper clockwise until the bezel ring indicator is aligned to '1'.

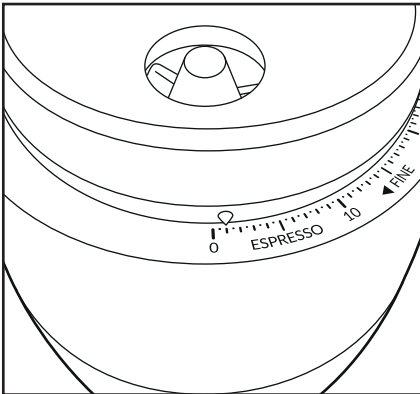

- 16.** Turn on the grinder and listen for the burrs touching. If you can hear the burrs touching then this is a more accurate zero point.

- 17.** If the burrs are not touching then rotate the bean hopper clockwise by 1 mark on the grind dial and retry. Repeat this process until you can hear the burrs touching.

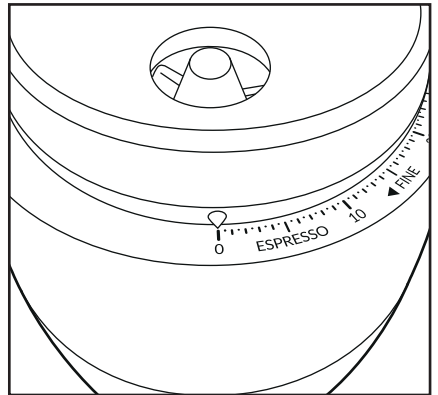

Zeroing the Niche Duo

18. Once the zero point has been established, rotate the bezel ring (black ring only) until the bezel ring indicator is aligned to '0'.

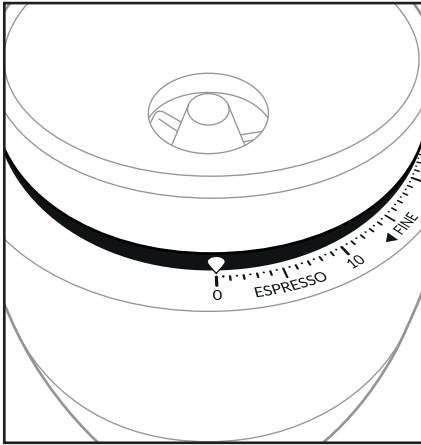

19. The burrs have been zeroed with the upper burr carrier in the first position. During manufacture it was established that this was the optimum position for the upper burr carrier and this has been recorded with a small silver sticker. To fully complete the zeroing process it is also important for you to establish if the upper burr carrier is in the optimum position.

20. Unscrew and remove the bean hopper. Make a note of the upper burr carrier position.



21. Lift the upper burr carrier out of the grind chamber and rotate it 120° until the carrier prongs are seated in the next position.

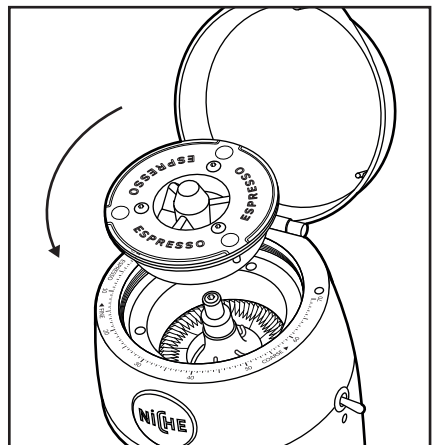

Zeroing the Niche Duo

22. Repeat the zeroing process (steps 5 - 17) for the new upper burr carrier position but do not adjust the bezel ring (step 12) until you've established if this is a better or worse upper burr carrier position (see step 23).

23. If the zero point is less than the '0' mark on the grind dial, the new upper burr carrier position is better than the original. In this case, rotate the bezel ring (black ring only) until the bezel ring indicator is aligned to '0'. If the zero point is greater than the '0' mark on the grind dial then do not adjust the bezel ring.

24. Repeat steps 20 - 23 to establish the optimum upper burr carrier position. Once established, place/keep the upper burr carrier in the optimum position and use one of the provided silver stickers to mark the position. Tighten the thumb screw on the underside of the bean hopper. Reseat the bean hopper and screw clockwise until lightly hand tight and then rotate anticlockwise to your desired setting on the grind dial.

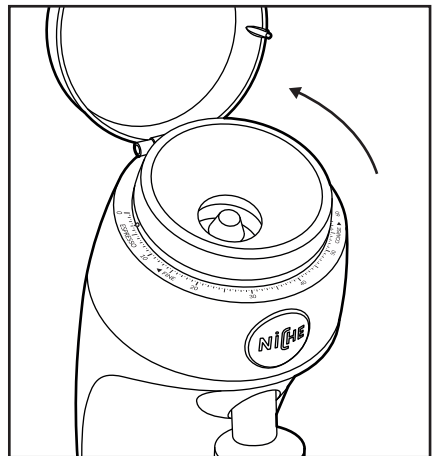
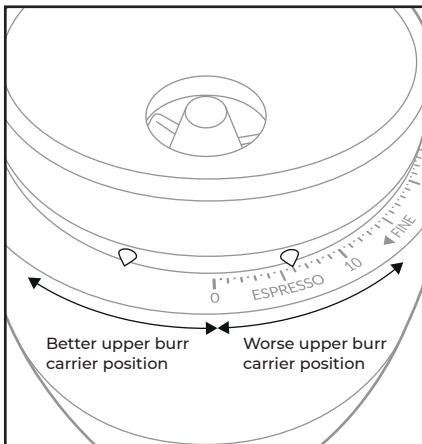

Troubleshooting

The Niche Duo does not run when turned on

Check to see if the Niche Duo is plugged into a grounded outlet and the lid is closed. If it is, unplug the grinder, then plug it back in again. If the grinder still does not work, check the plug fuse or circuit breaker on the electrical circuit the grinder is connected to and make sure the circuit is closed. If the grinder does not run after taking these steps, a foreign object may be jamming the cutting burrs. See the 'Care and Cleaning' section for more information.

The Niche Duo runs but does not grind coffee

The burrs require cleaning or are damaged. Also check that the bezel ring indicator is not set to '0' on the grind dial as this means the burrs are touching. See the 'Care and Cleaning' section for more information. Also check that the centre screw on the lower burr carrier is fitted and tight. See the 'Changing the Burrs' section.

The Niche Duo is operating normally, but stops abruptly

Immediately turn off the Niche Duo. A foreign object, such as a pebble, piece of metal or twig, may have jammed the burrs. See the 'Care and Cleaning' section for more information.

The grind size seems incorrect for the chosen setting

Ensure you're using the correct burr set for the brew type. You may also need to adjust your settings as your coffee gets older. If you are still having trouble, please zero your Niche Duo as described in the 'Zeroing the Niche Duo' section. Once zeroed, adjust the grind dial to your chosen setting.

The power cord does not pull out from the base

Unplug the Niche Duo. Unscrew and remove the wooden base cover and check that the cord is not knotted. Extend the cord, replace the wooden base cover and then push the cord back into the base.

Additional Information

First use after cleaning

You may notice a slight increase in grind retention for the first few uses after cleaning.

Seasoning burrs

Grind quality is good immediately but will improve after the first 3kg and continue to improve but at a slower rate up to 10kg of coffee. Burr life is in excess of 750kg.

Power cord storage

The Niche Duo is supplied with a 90cm power cord, which is stored in the base. Pull out to extend and push back in to shorten.

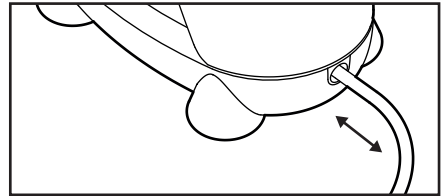

For more information
www.nichecoffee.co.uk
hello@nichecoffee.co.uk

Niche Coffee Limited is registered in England & Wales No. 08566128.
Registered office: Murrills House East Street, Portchester, England, PO16 9XS



Patent pending

Guarantee

This guarantee provides benefits which are additional to, and do not affect, your statutory rights. Niche Coffee Limited warrants to the original purchaser that this NICHE product, excluding items such as related documentation, will be free from defects in parts for one (1) year from the date of delivery. During the warranty period, NICHE will correct any defective parts or any failure of the NICHE product to conform to specifications by sending replacement parts, along with advice on how to fit them. Shipping costs for parts under warranty will be covered by Niche. Any replacement part/product shall be new and is warranted for the remainder of the original warranty or thirty (30) days from the date of shipment, whichever is longer. This warranty period is not extended as a result of purchasing any additional products from NICHE. The original purchaser must notify NICHE in writing within eight (8) days if there are defective parts. Written notice in all events must be received by NICHE before expiration of the warranty period. This warranty is not transferable. We may ask for further information including photos or video to help us diagnose the problem, so the appropriate part can be despatched. This guarantee does not cover the cost of returning the product to NICHE and this will be paid by the purchaser. If you wish to claim on your warranty or find out more information, please contact us by email – hello@nichecoffee.co.uk

This Limited Warranty covers normal domestic use only. NICHE does not warrant or cover:

- Damage caused by failure to provide a suitable installation environment for the NICHE product.
- Damage during shipment other than original shipment to the original purchaser.
- Damage caused by impact with other objects, dropping, falls, spilled liquids, or immersion in liquids.
- Damage caused by acts of God or disasters such as (but not limited to) fire, flood, wind, earthquake or lightning.
- Damage caused by unauthorised attachments, alterations, modifications or foreign objects.
- Damage caused by the use of the NICHE product for purposes other than those for which it was designed.
- Damage from improper maintenance.
- Damage caused by any other abuse, misuse, mishandling or misapplication.
- Consumable parts e.g. Burrs unless faulty from new.

Warranty

The warranty will not cover any breakages or wear and tear damage such as scratches, dents, stains or discolouration to all surfaces or other damage that does not impair the function of the grinder. NICHE and its supplier's liability for failure to repair the NICHE product to conform to the warranty after a reasonable number of attempts will be limited to a replacement of the NICHE product or at NICHE's option, to a refund not to exceed the purchase price of the NICHE product. These remedies are the original purchaser's exclusive remedies for breach of warranty. Under no circumstances shall NICHE or its suppliers be liable for any special, incidental, or consequential damages based upon breach of warranty, breach of contract, negligence, strict liability, or any other legal theory. Such excluded damages include, but are not limited to, loss of profits, loss of revenue, loss of data, loss of use of the NICHE product or any associated equipment, cost of capital, cost of substitute or replacement equipment, facilities or services, down time, original purchaser's time, the claims of third parties, including customers, and injury to property.

DISCLAIMER OF WARRANTIES

THE WARRANTY STATED ABOVE IS THE ONLY WARRANTY APPLICABLE TO THIS PRODUCT. ALL OTHER WARRANTIES, EXPRESS OR IMPLIED (INCLUDING ALL IMPLIED WARRANTIES OF MERCHANTABILITY OR FITNESS FOR A PARTICULAR PURPOSE), ARE HEREBY DISCLAIMED. NO ORAL OR WRITTEN INFORMATION OR ADVICE GIVEN BY NICHE, ITS AGENTS OR EMPLOYEES SHALL CREATE A WARRANTY OR IN ANY WAY INCREASE THE SCOPE OF THIS WARRANTY. IN THE EVENT OF INCONSISTENCY BETWEEN ANY TERMS OF THIS CONTRACT AND ANY TRANSLATION THEREOF INTO ANOTHER LANGUAGE, THE ENGLISH LANGUAGE VERSION SHALL PREVAIL.

This warranty is governed by English Law.

