

INSTALLATION MANUAL







Bathroom Vanity



Streamline

PRIOR TO INSTALLING

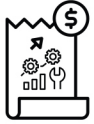

	<p>THESE PRODUCTS MUST BE INSTALLED BY A FULLY INSURED AND LICENSED INSTALLER ONLY.</p> <p>Installation of any product by anyone other than fully insured and licensed installer shall void limited warranty. We are not responsible for any local code compliance for this product.</p>
	<p>BUILDING AND PLUMBING CODES MAY VARY STATE-TO-STATE.</p>
	<p>STREAMLINE SHALL NOT BE HELD LIABLE FOR ANY AND ALL INCIDENTAL DAMAGES OR FLOOD CAUSED DUE TO USE OF THIS PRODUCT.</p>
	<p>STREAMLINE SHALL NOT BE RESPONSIBLE FOR SINK AND COUNTERTOP DAMAGE DURING INSTALLATION.</p>
	<p>STREAMLINE SHALL NOT BE HELD LIABLE FOR ANY AND ALL FEES STEMMING FROM COST OF INSTALLATION, RE-INSTALLATION, REMOVAL, SUBSEQUENT DAMAGE, OR TRANSPORTATION IN A CASE OF A PRODUCT DEFECT.</p>
	<p>DUE TO THE FRAGILE NATURE OF THE PRODUCT, INSPECTION OF THE BOX AND THE PRODUCT IS NECESSARY PRIOR TO INSTALLATION.</p>
	<p>SHOULD YOU FIND ANY DAMAGES OR ISSUES WITH THE PRODUCT, PLEASE CONTACT US AT support@streamlinebath.com WITH PHOTOS AND YOUR PURCHASE ORDER NUMBER.</p>

TOOLS REQUIRED

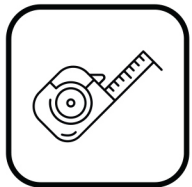

MEASURING TAPE



PENCIL



SAFETY GLASSES

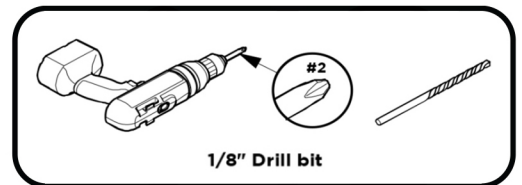

DRILL



SILICONE

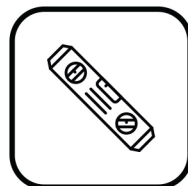

LEVEL BAR

MIRROR INSTALLATION

STEP 1

Carefully remove the mirror from its box.

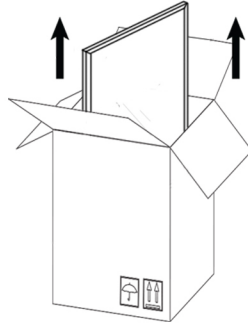

STEP 2

Measure the space where you would like to place the vanity in the bathroom. For accurate specifications, please refer to our website, streamlinebath.com.

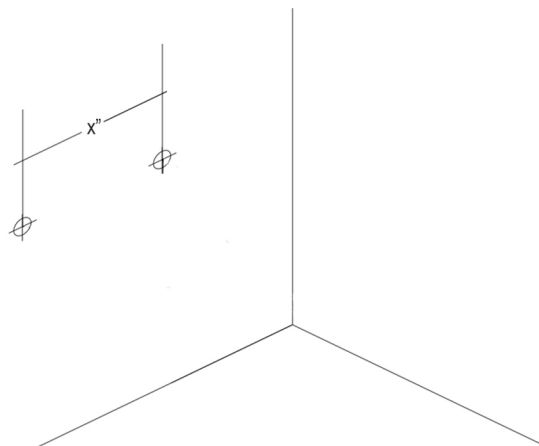

STEP 3

Determine in which manner you would like the mirror to be hung (horizontally or vertically).

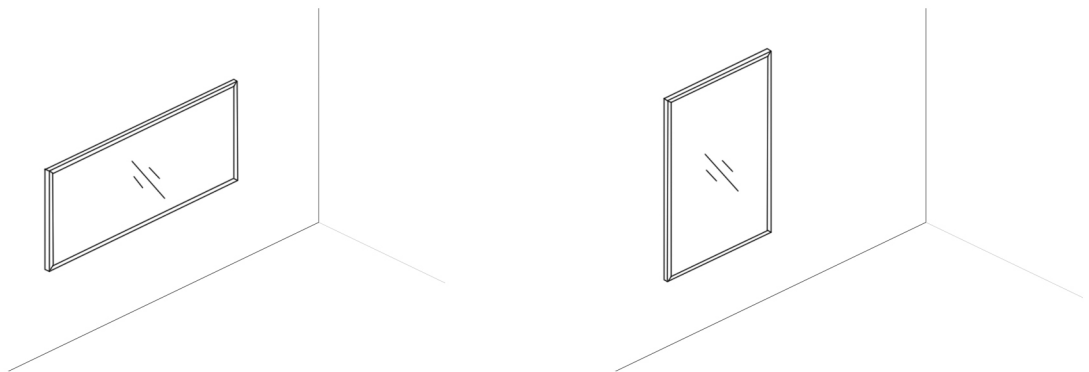

STEP 4

Using a pencil and a tape measure, mark the 2 points where the screws for the mirror will go on the wall. Make sure to accurately measure so that the mirror will align and hang on the screws. Use a level bar if necessary.

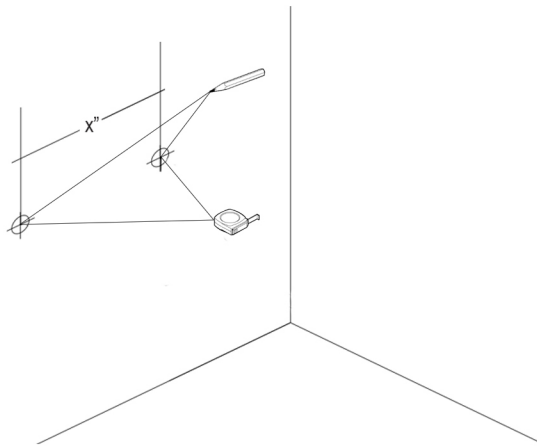

STEP 5

Using a drill, drill the screws into the wall.

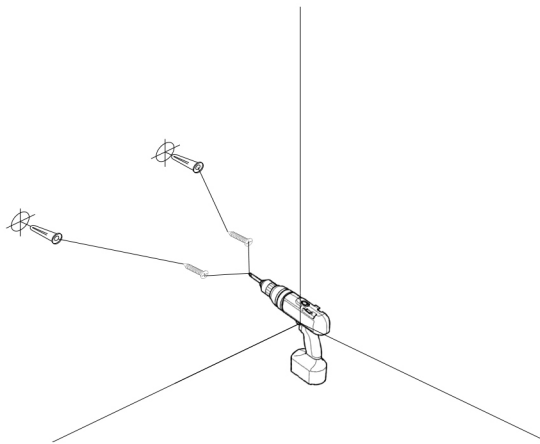

STEP 6

Using 2 people, gently lift the mirror and hang it on the affixed screws.

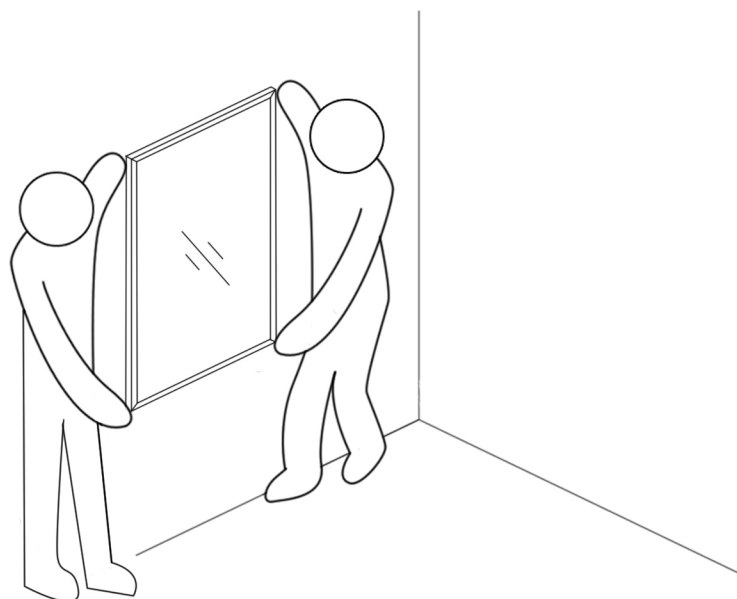

SINK & TOP INSTALLATION:

STEP 1

Carefully remove the vanity from its box.

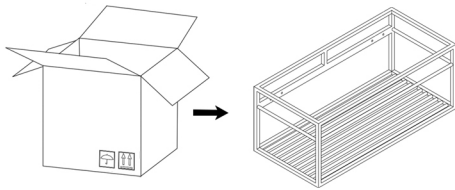

STEP 2

Measure the space where you would like to place the vanity in the bathroom. For accurate specifications, please refer to our website, streamlinebath.com.

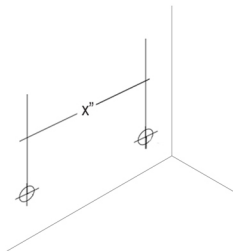

STEP 3

Using a pencil and a tape measure, mark the 4 points where the screws for the vanity will go on the wall. Make sure to accurately measure so that the vanity will align and hang on the screws.

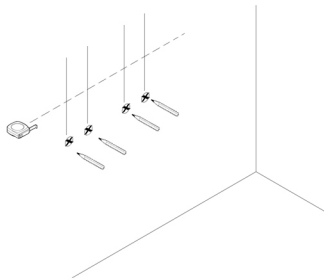

STEP 4

Using a drill, drill the screws into the wall.

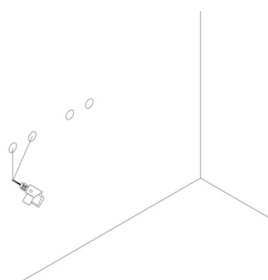

STEP 5

Using 2 people, gently lift the vanity and hang it on the affixed screws.

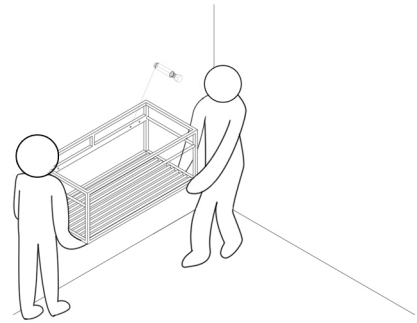

STEP 6

Unpack the vanity top from its packaging.

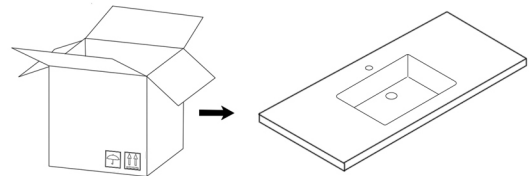

STEP 7

Using 2 people, carefully place the vanity top onto the vanity.

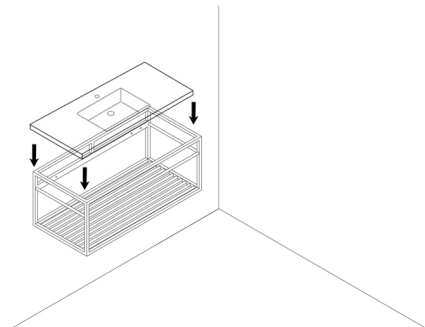

STEP 8

Use silicone to seal the vanity top in place.

