

HAVIT
COMMERCIAL

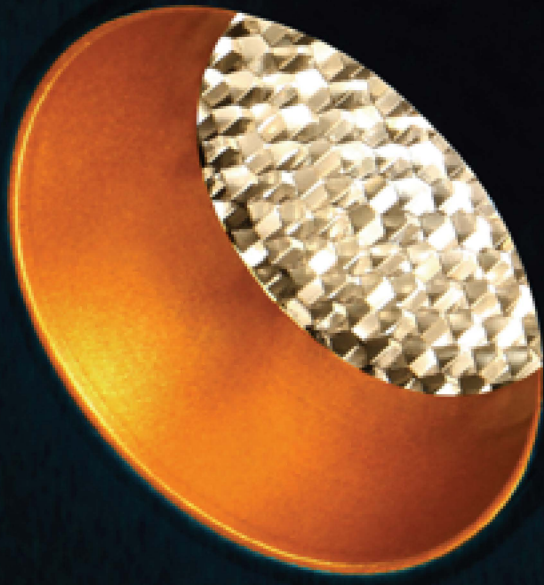



25W LED Track Light. No flickering, Happy to take pictures.



Invisible Care

Flicker free design, Tick-Lock adopted inside the track arm, Triac dimmable internal driver.

Flicker-free is aiming to create healthy lighting environment that make people enjoy photographs in any commercial occasions. Low UGR meanwhile offers high visual comfort. Optics changes can be made without any tools.

3/4

Simple Design

5/6

A Top Performer

7/8

Cool Design

9/10

Variants and Custom Options

11/12

Data Sheet



White

Black

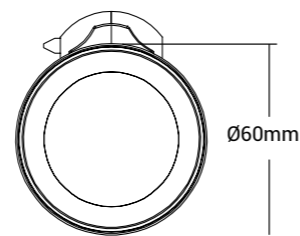
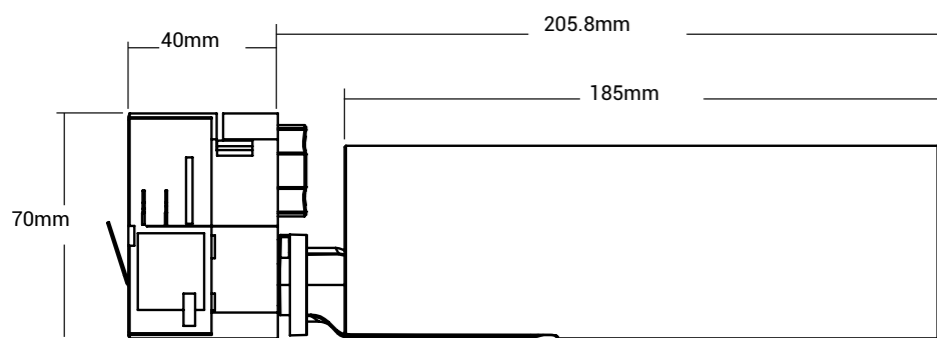

Simple Design

- The minimalistic design lets you be free from visual fatigue.
- The textured black or white finish prevents any fingerprints being left on fitting during installation.
- Tick mark on the track arm states precise directions for users.

Tick mark



Black



White



Golden

A Top Performer

- Two-stage driver solution, THD<10,
- Flicker free
- High Power Factor of 0.95,
- UGR<19,
- Compatible with 90% triac dimmers on the market,
- reliable brand electrical components are adopted in the driver.
- High powered 25 watts LED Chip with a high lumen output of up to 110lm/W
- The lens achieves accurate light beam without dot and color changing and perform naturally with less blue lights.

Well-organized connecting system,
say bye to chaos.

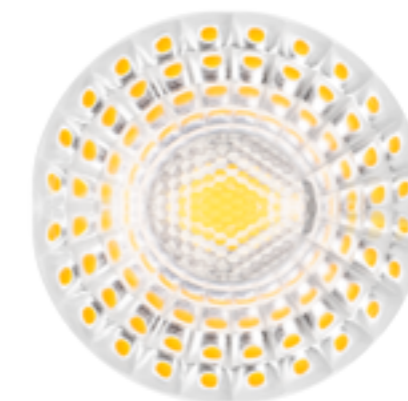

Lens

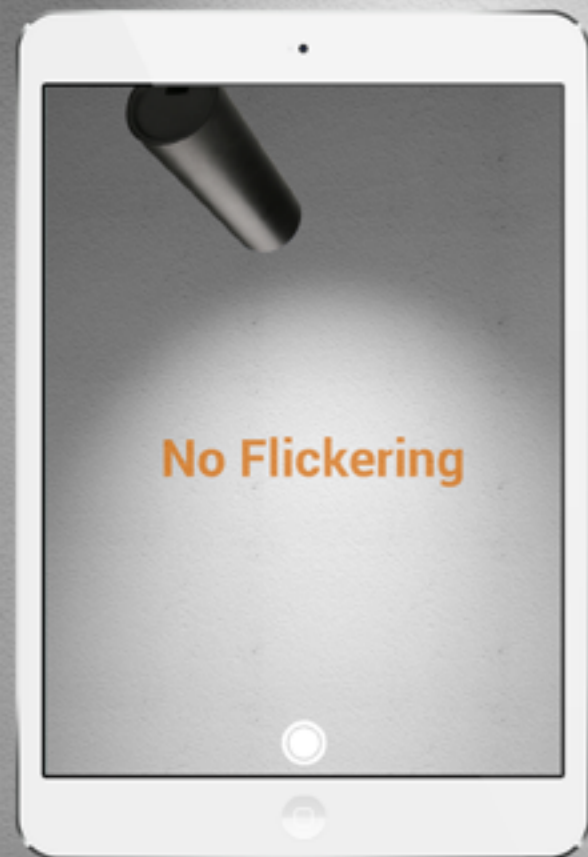

Cool Design

- Using die-casting aluminum in heatsink that can ensure the heat conduction in best idealization.
- Complex in mechanical design easy in assembling make it user-friendly. Users can assemble and disassemble accessories easier and faster.

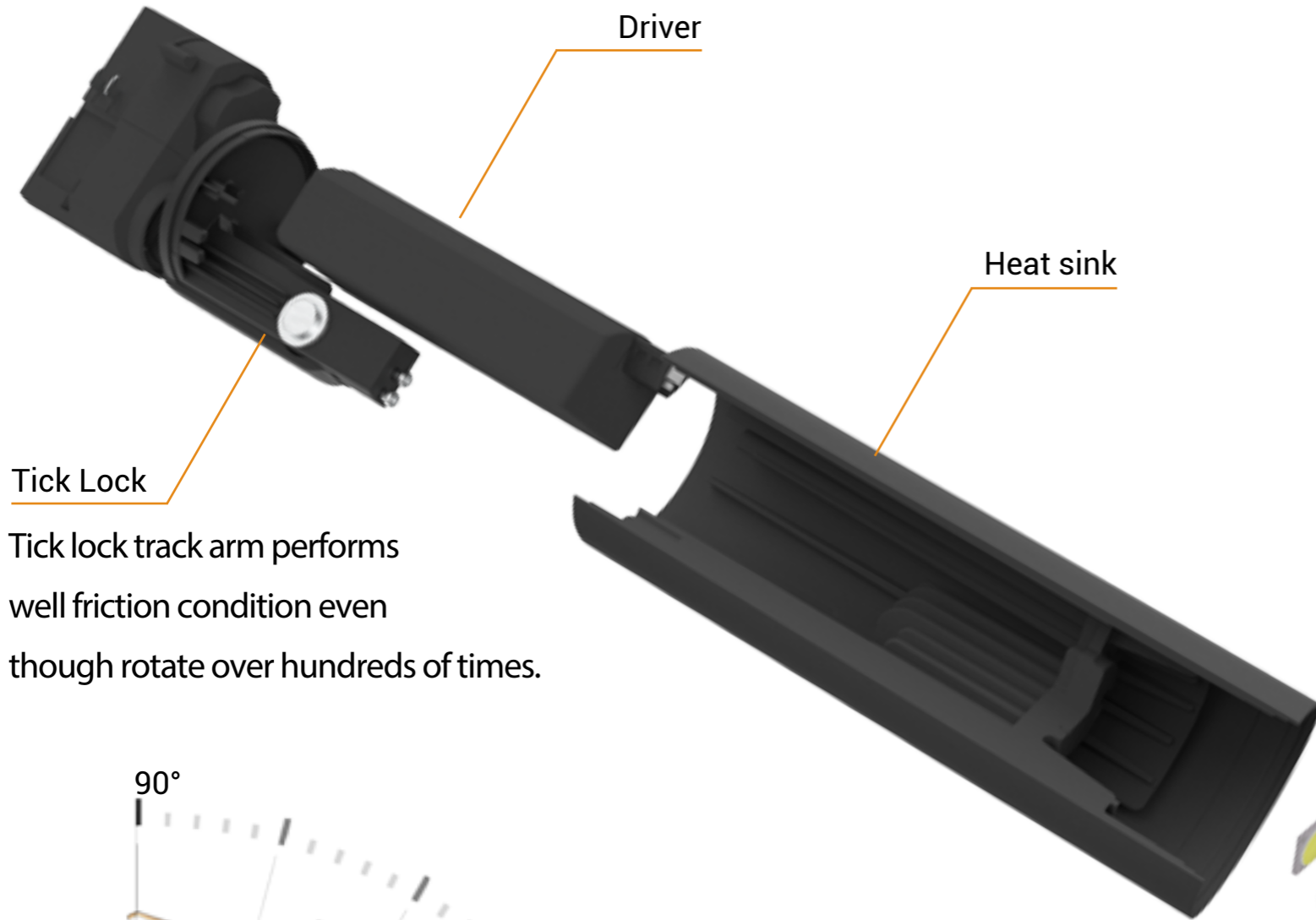

Tick Lock

Tick lock track arm performs well friction condition even though rotate over hundreds of times.

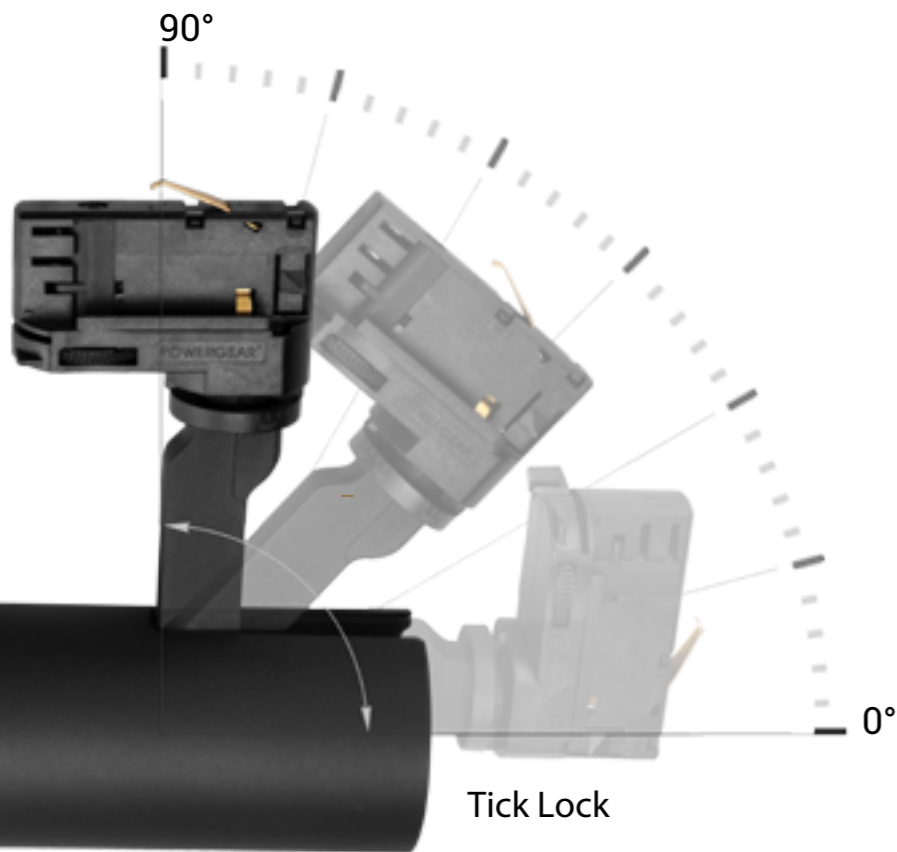

90°

0°

Tick Lock

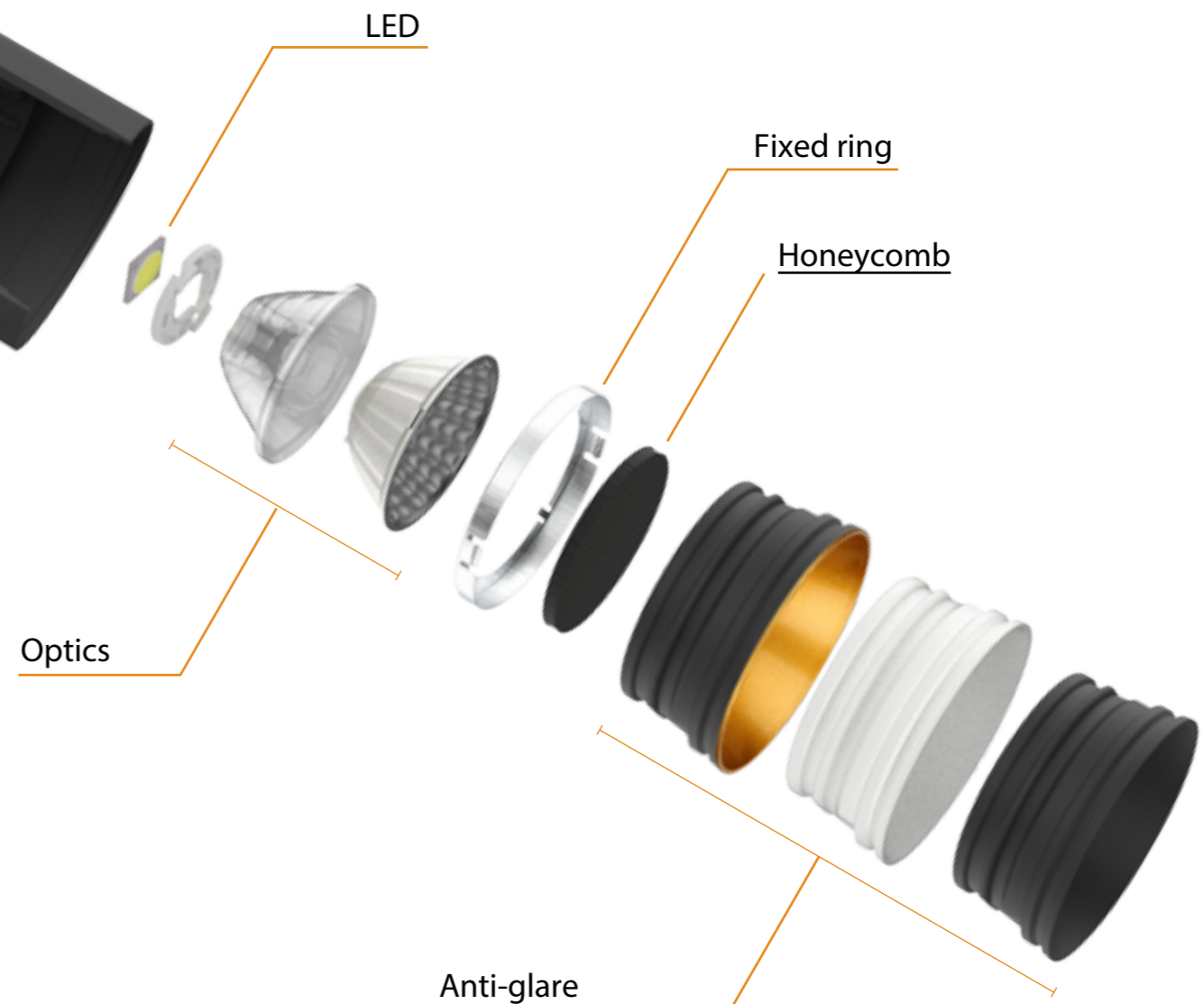

LED

Fixed ring

Honeycomb

Optics

Anti-glare

Variants and Custom Options

- Black and white finish as standard,
- Anti-glare rings are optional and available in white, black and gold.
- 60° standard beam angle with 18° / 24° / 36° as available options.
- Anti glare Honeycomb filter can be added.

Golden

White

Black

Lens

18° / 24° / 36° / 60°

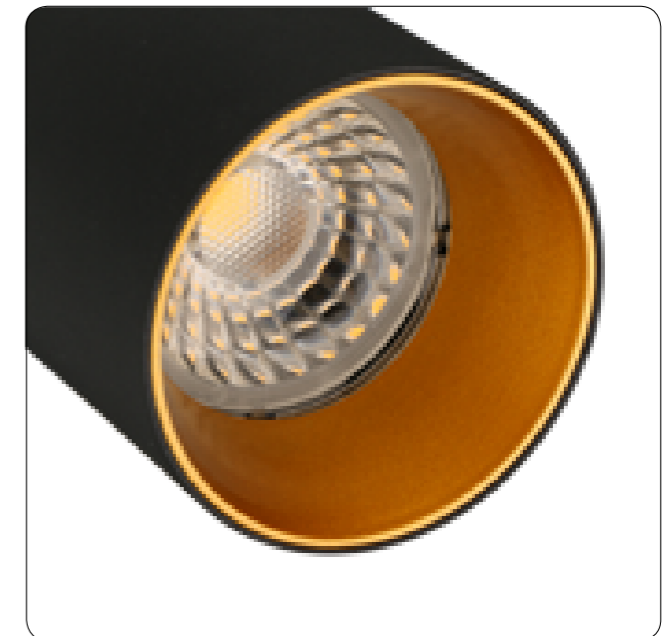

Normal

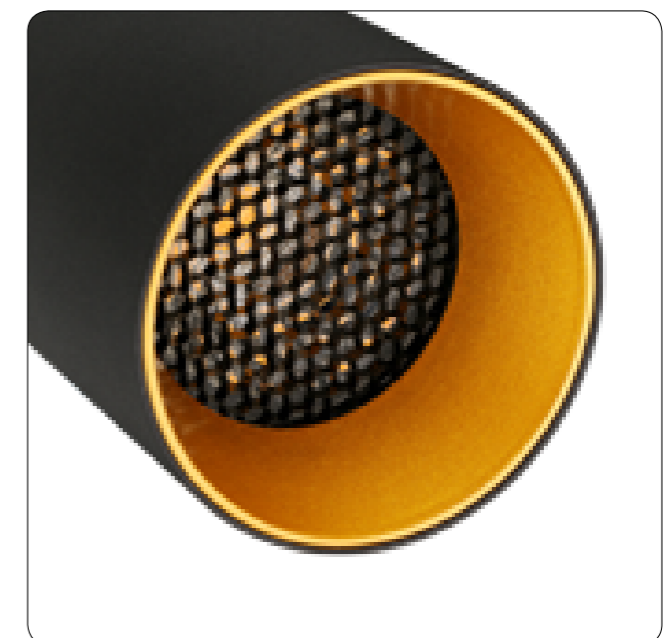

Honeycomb



Data Sheet

| Power | Input Voltage | Rated Input Current | PF value | IP Rated | CRI | Dimmable | Track System | Lifespan | Warranty |
|-------|-----------------------|---------------------|----------|----------|-----|----------|--------------|------------|----------|
| 25W | AC200-240V 50/60Hz | 0.195A | >0.9 | IP20 | 90+ | Yes | 3 Circuit | >40,000Hrs | 5 years |

Optics



| | Beam Angle | Beam Diameter (mm) | Beam Diameter (in) |
|-------|------------|--------------------|--------------------|
| 3000K | 18° | 2360lm | 102m/w |
| | 24° | 2340lm | 101m/w |
| | 36° | 2320lm | 100m/w |
| | 60° | 2200lm | 92m/w |
| 4000K | 18° | 2410lm | 104m/w |
| | 24° | 2380lm | 103m/w |
| | 36° | 2340lm | 101m/w |
| | 60° | 2230lm | 94m/w |
| 5000K | 18° | 2460lm | 104m/w |
| | 24° | 2425lm | 102m/w |
| | 36° | 2400lm | 100m/w |
| | 60° | 2280lm | 94m/w |

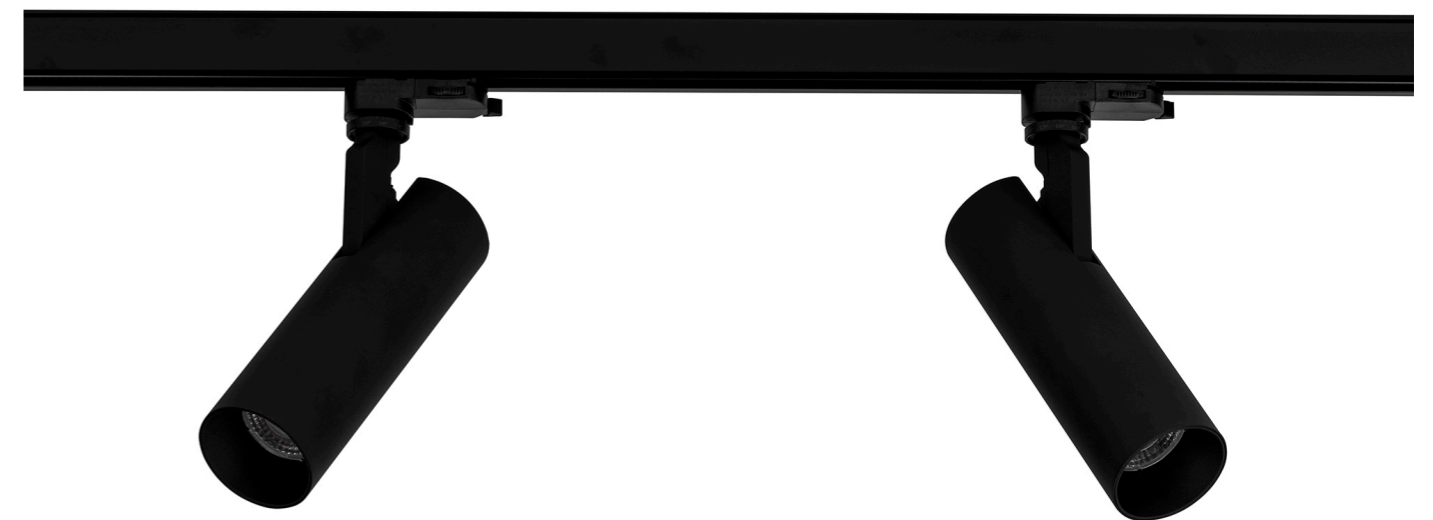
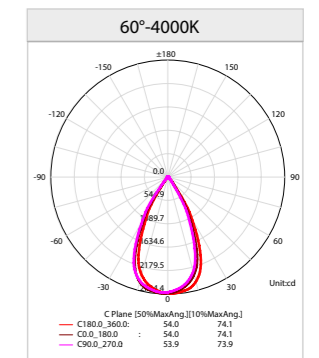
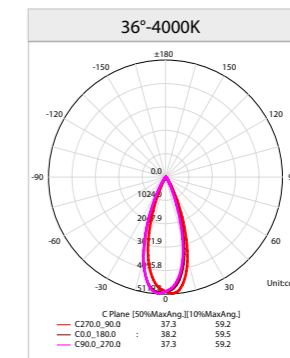
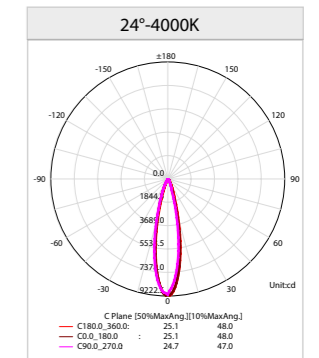
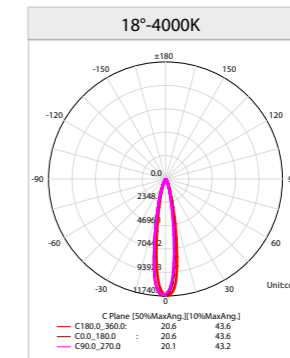



TEL | **+61-9381 8383**

E-mail | **sale@havitcommercial.com.au**

Web | **www.havitcommercial.com.au**

8/133 Beauchamp Road
Matrville, N.S.W. 2036
Australia