

9W DIM TO WARM RECESSED DOWNLIGHTS

PRODUCT SPECIFICATIONS

MATERIAL	ALUMINIUM + POLYCARBONATE
COLOUR / FINISH	MATT WHITE WITH WHITE INSERT
COLOUR TEMP	1800K - 3000K
LUMEN OUTPUT	685LM
INPUT VOLTAGE	240V (REMOTE DRIVER)
BUILT IN LED	9W LED
DIMMING	DALI
CRI	80+
BEAM ANGLE	90°
TILT	NO
CUT OUT	90MM
IP RATING	IP54
IC-4 RATING	YES (FITTING ONLY)
WARRANTY	5 YEARS REPLACEMENT*



Cut Out Ø90

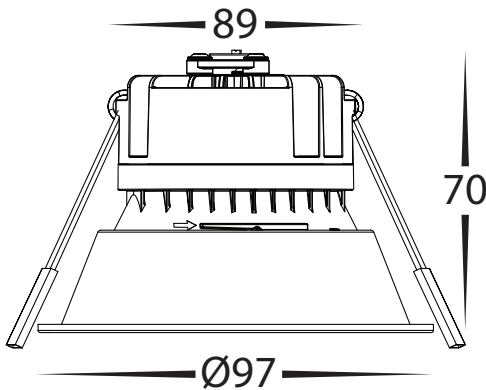

PHOTOMETRICS

C Plane Distribution Diagram

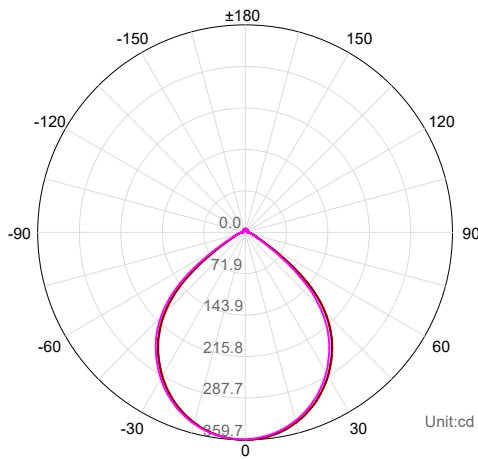

C Plane	[50%MaxAng.]	[10%MaxAng.]
— C180.0_360.0 :	93.8	124.9
— C0.0_180.0 :	93.8	124.9
— C90.0_270.0 :	93.6	124.8

WHITE

HCP-81341916	9W LED	1800K - 3000K	685LM
--------------	--------	---------------------	-------

